

TM-T70

**Technical reference
guide**

(ANK model)

English

410620800

EPSON

Cautions

- ❑ No part of this document may be reproduced, stored in a retrieval system, or transmitted in any form or by any means, electronic, mechanical, photocopying, recabing, or otherwise, without the prior written permission of Seiko Epson Corporation.
- ❑ The contents of this document are subject to change without notice. Please contact us for the latest information.
- ❑ While every precaution has been taken in the preparation of this document, Seiko Epson Corporation assumes no responsibility for errors or omissions.
- ❑ Neither is any liability assumed for damages resulting from the use of the information contained herein.
- ❑ Neither Seiko Epson Corporation nor its affiliates shall be liable to the purchaser of this product or third parties for damages, losses, costs, or expenses incurred by the purchaser or third parties as a result of: accident, misuse, or abuse of this product or unauthorized modifications, repairs, or alterations to this product, or (excluding the U.S.) failure to strictly comply with Seiko Epson Corporation’s operating and maintenance instructions.
- ❑ Seiko Epson Corporation shall not be liable against any damages or problems arising from the use of any options or any consumable products other than those designated as Original EPSON Products or EPSON Approved Products by Seiko Epson Corporation.

Trademarks

EPSON® and ESC/POS® are registered trademarks of Seiko Epson Corporation.

ESC/POS™ Command System

EPSON has been taking industry's initiatives with its own POS printer command system (ESC/POS). ESC/POS has a large number of commands including patented ones. Its high scalability enables users to build versatile POS systems. The system is compatible with all types of EPSON POS printers and displays. Moreover, its flexibility make it easy to upgrade in the future. The functionality and the user-friendliness is valued from around the world.

Revision History

Rev.	Page	Details of Change
Rev. A	All pages	Newly authorized

For Safety

Key to Symbols

The symbols in this manual are identified by their level of importance, as defined below. Read the following carefully before handling the product.



WARNING:

You must follow warnings carefully to avoid serious bodily injury.



CAUTION:

Provides information that must be observed to prevent damage to the equipment or loss of data.

- Possibility of sustaining physical injuries.*
- Possibility of causing physical damages.*
- Possibility of causing information loss.*



Note:

Provides important information and useful tips on handling the equipment.

Warnings

WARNING:

- ❑ *Shut down your equipment immediately if it produces smoke, a strange odor, or unusual noise. Continued use may lead to fire or electric shock. Immediately unplug the equipment.*
- ❑ *Only disassemble this product as described in this manual. Do not make modifications to the unit. Tampering with this product may result in injury, fire, or electric shock.*
- ❑ *To avoid risk of electric shock, do not set up this product or handle cables during a thunderstorm in order.*
- ❑ *Be sure to use the specified power source. Connection to an improper power source may cause fire or shock.*
- ❑ *Never insert or disconnect the power plug with wet hands. Doing so may result in severe shock.*
- ❑ *Do not allow foreign matter to fall into the equipment. Penetration by foreign objects may lead to fire or electric shock.*
- ❑ *If water or other liquid spills into this equipment, turn off the power supply switch and unplug the power cable immediately. Continued usage may lead to fire or electric shock.*
- ❑ *Do not place multiple loads on power outlet. Overloading the outlet may lead to fire.*
- ❑ *Handle the power cable with care. Improper handling may lead to fire or electric shock.*
 - *Do not modify or attempt to repair the cable.*
 - *Do not place any heavy object on top of the cable.*
 - *Avoid excessive bending, twisting and pulling.*
 - *Do not place the cable near heating equipment.*
 - *Check that the plug is clean before plugging it in.*
 - *Be sure to push the plug all the way in.*
- ❑ *Keep the DIP switch cover closed and fastened with the screw. Using the printer with the cover open may cause fire or electric shock.*

Cautions

CAUTION:

- Be sure to set this equipment on a firm, stable horizontal surface. Product may break or cause injury if it falls.
- Do not use in locations subject to high humidity or dust levels. Excessive humidity and dust may cause equipment damage, fire or shock.
- Do not place heavy objects on top of this equipment. Never stand or lean on this equipment. Equipment may fall or collapse, causing breakage and possible injury.
- To ensure safety, unplug this equipment prior to leaving it unused for an extended period.
- Parts on the circuit board may become hot during operation. Wait approximately 10 minutes after turning the power off before touching them.
- To avoid injury, take care not to insert fingers or any part of the hand in the roll paper opening where the manual cutter is installed.
- Do not open the roll paper cover without taking the necessary precautions, as this can result in injury from the autocutter fixed blade.
- Do not use aerosol sprayers containing flammable gas inside or around this product. Doing so may cause fire.
- The thermal head can be very hot during printing and immediately after printing. Touching it may cause burns. Be sure to do cleaning and other work after the thermal head cools down.

Modular Connectors

The printer uses the modular connectors specifically designed for the cash drawer. Do not connect these connectors to an ordinary telephone line.

EMC and Safety Standards Applied

Product Name: TM-T70
Model Name: M255A

The following standards are applied only to the printers that are so labeled. (EMC is tested using the Epson power supplies.)

Europe: CE marking
Safety: EN 60950-1

North America: EMI: FCC/ICES-003 Class A
Safety: UL60950-1/CSA C22.2 No. 60950-1

Oceania: EMC: AS/NZS CISPR22 Class B

Conditions of Acceptability

1. The supply source shall be SELV and non-hazardous energy level (less than 240VA).
2. When this product is installed in the product which has a total mass not exceeding 18kg, the enclosure of this product were evaluated as a fire enclosure.
3. The interface connectors except for input connector shall be described in installation or safety instruction to identify Non-LPS at end product.

WARNING:

The connection of a non-shielded printer interface cable to this printer will invalidate the EMC standards of this device. You are cautioned that changes or modifications not expressly approved by Seiko Epson Corporation could void your authority to operate the equipment.

The interface connectors are supplied from Non-LPS.

CE Marking

The printer conforms to the following Directives and Norms:

Directive 89/336/EEC	EN 55022 Class B
	EN 55024
	IEC 61000-4-2
	IEC 61000-4-3
	IEC 61000-4-4
	IEC 61000-4-5
	IEC 61000-4-6
	IEC 61000-4-11

FCC Compliance Statement For American Users

This equipment has been tested and found to comply with the limits for a Class A digital device, pursuant to Part 15 of the FCC Rules. These limits are designed to provide reasonable protection against harmful interference when the equipment is operated in a commercial environment.

This equipment generates, uses, and can radiate radio frequency energy and, if not installed and used in accordance with the instruction manual, may cause harmful interference to radio communications.

Operation of this equipment in a residential area is likely to cause harmful interference, in which case the user will be required to correct the interference at his own expense.

For Canadian Users

This Class A digital apparatus complies with Canadian ICES-003.

About this Manual

This manual describes the TM-T70, a current EPSON thermal printer product.

The currently available power supply, the PS-180, works with TM-T70.

Aim of the Manual

This manual was created to provide all the information necessary for system planning, design, installation, and application of the printer for designers and developers of POS system.

Manual Content

The manual is made up of the following sections:

Chapter 1	Product Overview
Chapter 2	Setup
Chapter 3	Application Development Information
Chapter 4	ESC/POS Command-related Information
Chapter 5	Product Specifications
Appendix A	Interfaces and Connectors
Appendix B	Options and Consumables
Appendix C	Character Code Tables

Related Software and Documents

Documents relating to the TM-T70 are listed below.

Name of document	Description
TM-T70 User's Manual	Provides information to enable POS operators to use the TM-T70 safely and correctly. This manual is packed in the box with the printer.*
ESC/POS Application Programming Guide	Provides detailed ESC/POS command information. Contact us to obtain this guide.
TM-T70 Technical Reference Guide	This guide.*
EPSON OPOS ADK	This is an OCX driver.*

Name of document	Description
EPSON OPOS ADK Manual	Provides information for anyone who is programming using OPOS. This is included in the EPSON OPOS ADK.*
EPSON Advanced Printer Driver	This is a Windows driver.*
EPSON Advanced Printer Driver Manual	Provides information for anyone who is programming using the APD (EPSON Advanced Printer Driver). This is included in the EPSON Advanced Printer Driver.*

* You can obtain these items from one of the following URLs:

For customers from North America: <http://pos.epson.com/>

For customers from other countries: <http://epson-pos.com/>

Select the product from the "Select any product" pull-down menu.

Contents

Chapter 1 **Product Overview**

Features	1-1
Product Structure	1-2
Model	1-2
Accessories	1-2
Options	1-2
Consumable products	1-2
TM-T70 Basic Specification Table	1-3
Part Names and Basic Operation	1-3
Part Names	1-3
Control Panel	1-4
Power Switch	1-5
Connectors	1-5
Handling the Printer	1-5
Installing and Replacing Roll Paper	1-6
Removing Jammed Paper	1-8
Power Switch Cover	1-8
Shipping Procedures	1-9

Chapter 2 **Setup**

Installing the Printer	2-1
Setting the DIP Switches	2-3
DIP Switch Positions and Steps for Changing DIP Switch Settings	2-3
DIP Switch Functions	2-3
Connecting the Printer to the Host Computer	2-7
Serial Interface Connection	2-7
Parallel Interface Connection	2-9
USB Interface Connection	2-10
Ethernet Interface Connection	2-12
Wireless LAN Interface Connection	2-14
Connecting Power Supply Unit and Cash Drawer	2-14
Connecting the Power Supply Unit	2-14
Connecting the Drawer Kick-out Cable	2-15
Installing the Driver	2-16

Chapter 3 **Application Development Information**

Introducing the Control Methods	3-1
Windows Driver (EPSON Advanced Printer Driver)	3-1
EPSON OPOS ADK	3-3
ESC/POS Commands	3-6
Various Utilities	3-6
Switches and Buttons	3-6
FEED Button	3-7
Panel LEDs and Error Status	3-7
(POWER) LED	3-7
PAPER OUT LED	3-7
Error LED	3-7
Sensors	3-9
Paper Sensors	3-9
Printer Cover Sensor	3-10
Offline	3-10
Busy State	3-10

NVRAM (Non-volatile Memory)	3-11
Bar Code Printing	3-12
Notes on Printing 2-Dimensional Code	3-12
Operating Mode (Switch Panel Operation)	3-12
Self-test Mode	3-12
FAQ List	3-13
Q: Why has my print data dropped out?	3-13
Q: Why does the drawer kick-out not operate properly?	3-14
Q: I cannot print part of Page 0 in Visual Basic. Why?	3-15

Chapter 4 **ESC/POS Command-related Information**

NV Memory (Non-volatile Memory)	4-1
Using NV Memory	4-1
Printer Status	4-2
Precautions When the Printer Is Offline	4-2
Outputting Hex Dumps	4-2

Chapter 5 **Product Specifications**

Product Specifications (TM-T70)	5-1
Print Specifications (TM-T70)	5-1
Character Specifications (TM-T70)	5-2
Paper Specifications (TM-T70)	5-3
Printable Area (TM-T70)	5-3
Print Position versus Cutter Position (TM-70)	5-4
Overview of External Dimensions (TM-T70)	5-5
External Dimensions	5-5
Operating Specifications (TM-T70)	5-6

Appendix A **Interfaces and Connectors**

RS-232 Serial Interface	A-1
Interface Board Specifications (RS-232-compliant)	A-1
Functions of each Connector Pin	A-2
XON/XOFF	A-2
Code	A-3
IEEE 1284 Parallel Interface	A-3
Modes	A-3
Interface Signals	A-5

Appendix B **Options and Consumables**

Roll Paper	B-1
Power Supply	B-1
PS-180	B-1

Appendix C **Character Code Tables**

Page 0 (PC437: USA, Standard Europe)	C-1
Page 1 (Katakana)	C-2
Page 2 (PC850: Multilingual)	C-3
Page 3 (PC860: Portuguese)	C-4
Page 4 (PC863: Canadian-French)	C-5
Page 5 (PC865: Nordic)	C-6
Page 16 (WPC1252)	C-7
Page 17 (PC866: Cyrillic #2)	C-8
Page 18 (PC852: Latin2)	C-9
Page 19 (PC858: Euro)	C-10
Page 255 (Blank Page)	C-11
International Character Set	C-12

Chapter 1

Product Overview

The TM-T70 thermal printer product is currently available from EPSON. In addition, the PS-170, the power supply, is obsolete and no longer available. It is described only for legacy support. The currently available power supply, the PS-180, works with TM-T70.

1.1 Features

The TM-T70 printer has the following features:

- ❑ Printing
 - High-speed printing (170 mm/s {6.69"/s} maximum), which enables issuing of batch receipts.
 - Graphics are also printed with a high-speed printing.
- ❑ Printer handling
 - Easy drop-in paper loading.
 - Front access operation for receipt ejection (horizontal direction) and roll paper exchange.
 - Front access operation of the power button and operation panel.
- ❑ Software
 - Command protocol is based on the ESC/POS[®] Proprietary Command System.
 - OPOS ADK and Windows[®] printer drivers are available.
 - In addition to supporting several kinds of bar code printing, two-dimensional code (PDF417, QR code) printing is possible.
 - Various layouts are possible by using page mode.
 - A maintenance counter function is supported.
- ❑ General
 - Various interface boards (EPSON UB series) can be used.

1.2 Product Structure

1.2.1 Model

- ❑ Product Name TM-T70 (current product)
 - Print method: Thermal line printing
 - Interface specifications:
 - Serial interface specifications (RS-232C)
 - Parallel interface specifications (IEEE 1284-compliant)
 - USB interface specifications (Full speed)
 - Ethernet interface specifications (10/100BASE-T)
 - Wireless LAN interface specifications (802.11b)
 - Paper width specifications:
 - 80 mm {3.15"} width specifications

1.2.2 Accessories

- ❑ Printer (body)
- ❑ Roll paper × 1
- ❑ User's manual × 1
- ❑ Power switch cover × 1

1.2.3 Options

- ❑ External power supply unit
 - Model PS-180 (PS-180 supports the power-saving feature.)
- ❑ Affixing tapes (Model: DF-10)
- ❑ Various interface board (UB series)
- ❑ Connector cover (Model: OT-CC70)

1.2.4 Consumable products

- ❑ Specified paper: Thermal paper

1.2.5 TM-T70 Basic Specification Table

Table 1-1

	TM-T70
1. High-speed print mode	Approx. 170 mm/s (6.99") maximum
2. High-speed power consumption mode	Average : Approx. 1.8A
3. Serial interface selectable baud rates	2400, 4800, 9600, 19200, 38400, 57600, 115200 Default Setting: 115200 Settable baud rate with DIP switches 1-7/1-8: 4800, 9600, 19200 Settable baud rate with commands: 2400, 4800, 9600, 19200, 38400, 57600, 115200
4. Conditions for canceling receive buffer BUSY state *	Set with DIP SW2-5 *
5. Supported character sets (extended graphics)	11 pages including WPC 1252, PC866 (Cyrillic #2), PC852 (Latin2))
6. Driver (EPSON OPOS ADK, Advanced Printer Driver)	<ul style="list-style-type: none"> Some baud rates cannot be used in serial communications (38400 bps). <p>Note: The driver cannot set a 38400 bps baud rate.</p>

* For details on the conditions for canceling the receive buffer BUSY state, refer to "DIP Switch Functions" (page 2-3).

1.3 Part Names and Basic Operation

1.3.1 Part Names

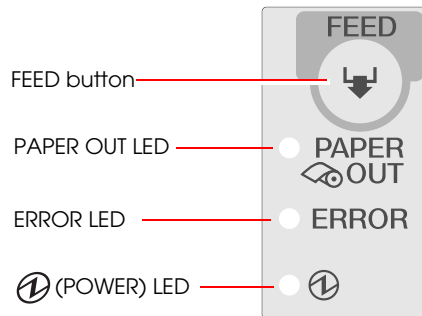

Figure 1-1 Printer part names

* For details on DIP switch settings, refer to "DIP Switch Positions and Steps for Changing DIP Switch Settings" (page 2-3).

1.3.2 Control Panel

TM-T70



1.3.2.1 LED

(POWER) LED (green)

- ❑ Lights when the power supply is on.
- ❑ Goes out when the power supply is turned off.

ERROR LED

Lights or flashes when the printer is offline.

- ❑ Lights after the power is turned on or after a reset (offline). Automatically goes out after a while to indicate that the printer is ready. Lights when the end of the roll paper is detected, and when printing has stopped (offline). If this happens, replace with new roll paper.
- ❑ Flashes when an error occurs. (For details about the flash codes, refer to “Error Codes” (page 3-7).)
- ❑ Goes out during regular operation (online).

PAPER OUT LED

- ❑ Lights when there is no more roll paper or there is little remaining.
- ❑ Goes out when there is a sufficient amount of roll paper remaining.
- ❑ Flashes when a self-test is in progress.

1.3.2.2 Buttons

FEED button

Pressing this button once feeds the roll paper by one line. Holding this button down feeds the roll paper continuously.

1.3.3 Power Switch

The power switch is located at the bottom right front of the printer. (Refer to “Printer part names” (page 1-3).)

Turn the printer on or off. The marks on the switch ( / |) indicate the printer switch position.

CAUTION:

Before turning on the printer be sure to check that the AC adapter is connected to the power supply.

1.3.4 Connectors

All cables are connected to the connector panel on the lower rear of the printer.

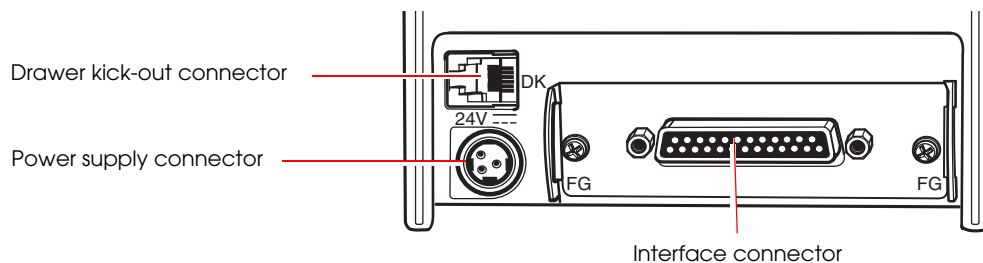

Figure 1-2 Connector panel

- Drawer kick-out connector for connecting the cash drawer
- Power supply connector for connecting the power supply unit
- Interface connector to connect the printer to the host computer interface (serial, parallel, etc.)

Note:

The picture above shows a serial interface model. For details on the various interfaces and how to connect the power supply connector and cash drawer, see “Connecting Power Supply Unit and Cash Drawer” (page 2-14) and “Connecting the Printer to the Host Computer” (page 2-7).

1.4 Handling the Printer

WARNING:

Do not open the printer cover during printing. Doing so may damage the printer.

Do not touch the emergency cutter with your hands when installing or replacing roll paper. The emergency cutter is sharp and may cause an injury.

1.4.1 Installing and Replacing Roll Paper



Note:

Be sure to use roll paper that meets printer specifications. See Appendix B for details on the paper specifications.

Do not use roll paper whose trailing end is glued to the roll paper core.

1.4.1.1 Installing Roll Paper

1. Check that printing is stopped, and press the cover open button to open the printer cover.



Figure 1-3 Cover open button

2. Load the roll paper.

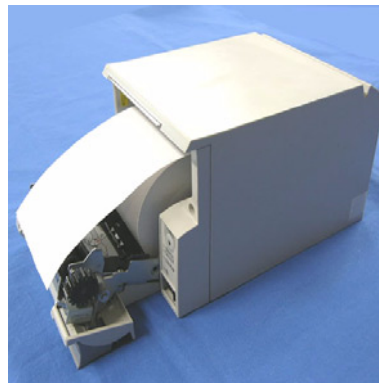

Figure 1-4 Loading paper



Note:

When loading the roll paper, pay attention to the direction that the roll paper is fed out of the printer.

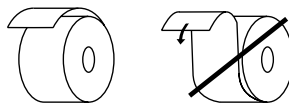

Figure 1-5 Paper direction

3. Pull out the roll paper toward you, then set it so that it fits between the left and right paper guides on top of the printer cover.

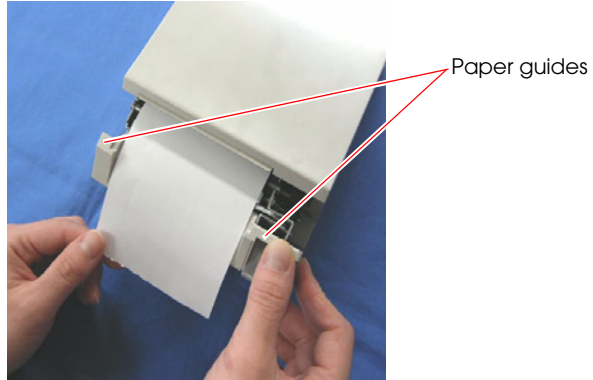

Figure 1-6 Pulling out the roll paper

4. Close the printer cover.



Figure 1-7 Closing the printer cover

5. Tear off the leading edge of the roll paper.



Figure 1-8 Tear off paper

1.4.1.2 Replacing Paper

Follow the procedure below to replace roll paper.

1. Open the printer cover, and remove the core of the previously used roll paper.
2. Insert the new roll paper following the procedure in “Installing Roll Paper” (page 1-6).

1.4.2 Removing Jammed Paper

CAUTION:

Do not touch the thermal head because it can be very hot after printing. For handling the thermal head, refer to TM-T70 User’s Manual.

1. Turn the printer off and press the cover open lever.
2. Remove jammed paper, reinstall the roll, and close the cover.

1.4.3 Power Switch Cover

Install the power switch cover that comes with the TM-T70 onto the printer to prevent inadvertent changing of the power switch, to prevent tampering, and to improve the appearance of the printer.

To reset the TM printer when the power switch cover is installed, insert a long, thin object (such as the end of a paper clip) into the hole in the power switch cover and press the power switch.



Note:

If an accident occurs with the power switch cover attached, unplug the power cord immediately. Continued use may cause fire or shock.

1.4.4 Shipping Procedures

Do the following before shipping the printer.

1. Press the power switch to turn the power off.
2. Make sure the  LED is out.
3. Remove the power supply connector.
4. Remove the roll paper.
5. Pack the printer, keeping the top and bottom correctly oriented.

Chapter 2

Setup

Before using the printer, you need to make various settings to increase the printer's functionality. Configure the printer appropriately depending on the environment.

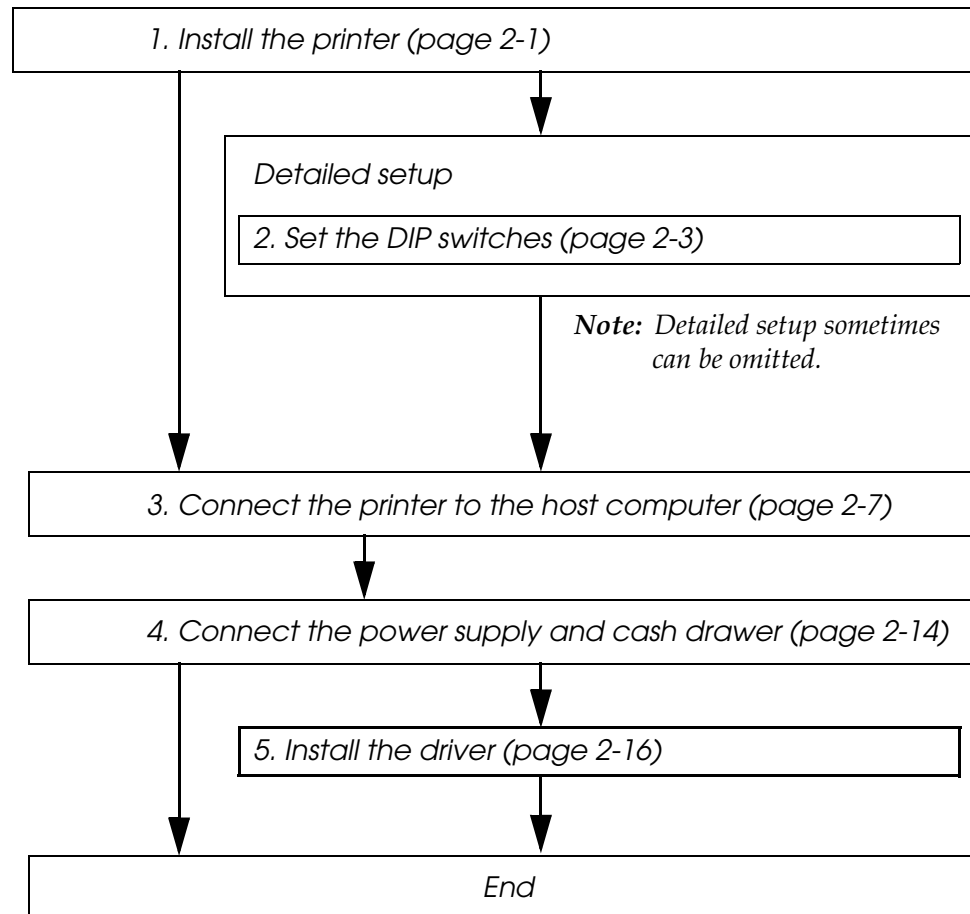

Figure 2-9 Setup flowchart

2.1 Installing the Printer

You can install this printer only horizontally.

- Install the printer in a flat, horizontal position.
- Avoid locations susceptible to dust and other foreign matter.
- Be sure to avoid bumping so that the printer is not exposed to strong impact during operation.
- Avoid placing the printer on top of the power supply or other cables or other objects.

Fix the printer so that it does not move around when you open the printer cover and cut roll paper. A tape for fixing the printer is available as an option.

As shown in the illustration below, install the printer with a maximum tilt of 3°. Installing the printer with a tilt of more than 3° may cause the following problems.

- Roll paper near end cannot be detected.
- The printer cover will not close after installing roll paper.
- Roll paper cannot be taken out.

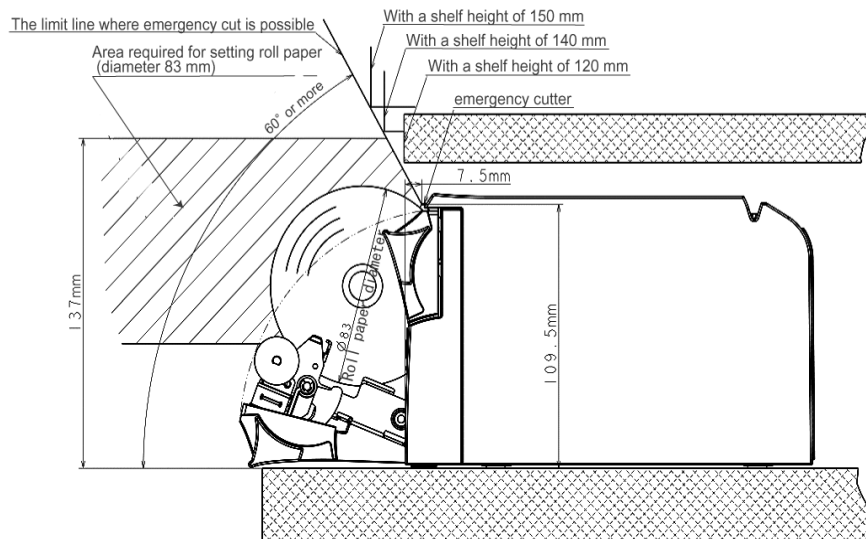
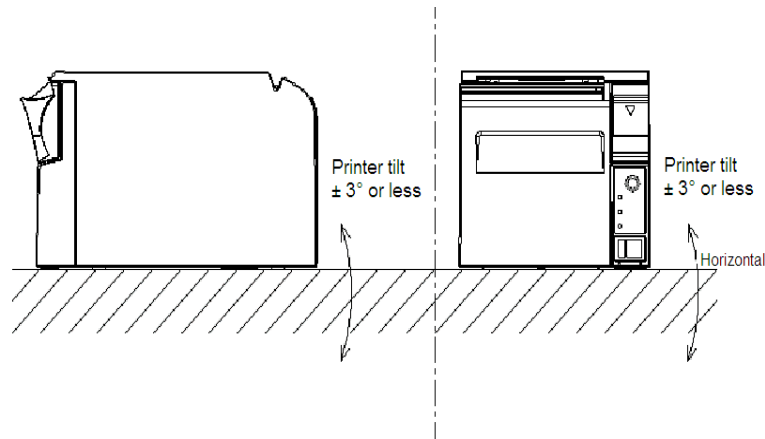

Figure 2-10 Placed on a shelf



Note:

If the printer is located in a place with less space than in the diagram above, 1) it may not be possible to install roll paper and 2) the emergency cutter may not be able to cut the paper. Other problems may also arise.

2.2 Setting the DIP Switches

On this printer, you can make various settings with DIP switches.



Serial interface communication conditions must be set on serial interface model printers.

2.2.1 DIP Switch Positions and Steps for Changing DIP Switch Settings

Follow the steps below to change the DIP switch settings.

CAUTION:

Before you remove the DIP switch cover, turn the printer off. Otherwise, a short-circuit may cause the printer to malfunction.

1. Make sure the power supply for the printer is turned off.
2. Unscrew the screw to remove the DIP switch cover from the base of the printer.

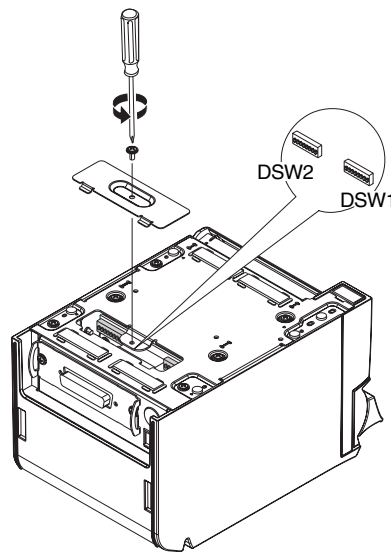

Figure 2-11 Removing the DIP switch cover

3. Set the DIP switches as desired, using the tip of a tool, such as a small screwdriver.
4. Attach the DIP switch cover, and screw in place.



New DIP switch settings are enabled after the printer is turned on.

2.2.2 DIP Switch Functions

The DIP switch functions depend on your printer's interface specifications.

2.2.2.1 DIP switch settings for serial interface specifications



Note:

* Factory setting

Table 2-2 Dip Switch bank 1 settings

SW	Function	ON	OFF	DEFAULT
1-1	Data receive error	Ignore	"?" is printed *	OFF
1-2	Receive buffer size	45 bytes	4KB *	OFF
1-3	Handshake	XON/XOFF	DTR/DSR *	OFF
1-4	Bit length	7 bits	8 bits *	OFF
1-5	Parity check	Yes	No *	OFF
1-6	Parity selection	Even	Odd *	OFF
1-7, 1-8	Baud rate selection (See the "Baud rate selection" tables below.)			ON
				ON

Table 2-3 Baud rate selection (DIP SW1-7, 1-8)

TM-T70

Baud rate (bps)	Switch no.	
	1-7	1-8
Adjustable by control commands (Default)*1	ON	ON
4800	OFF	ON
9600	ON	OFF
19200	OFF	OFF

*1 The baud rate can be changed with the setting values for the communication conditions of the serial interface. The serial interface communication conditions can be changed using command. The setting values are 2400, 4800, 9600, 19200, 38400, 57600, and 115200. The factory default is 115200.



Note:

The values of the communication conditions of the serial interface set with commands are enabled only when DIP switches 1-7 and 1-8 are On. Otherwise, the value selected with DIP switch 1 has priority.

Table 2-4 Dip Switch bank 2 settings

SW	Function	ON	OFF	DEFAULT
2-1	Handshake (BUSY) conditions	• Receive buffer full	• Offline • Receive buffer full*	OFF
2-2	Reserved (do not change setting)	Fixed to OFF		OFF
2-3, 2-4	Print density selection/low-power mode	(See separate table.)		OFF
2-5	Reserved (Always use printer with these switches to OFF.)	—	—	OFF
2-6	Reserved (do not change setting)	Fixed to OFF		OFF
2-7	Pin # 6 reset signal	Used	Not used *	OFF
2-8	Pin # 25 reset signal	Used	Not used *	OFF

For details on DIP SW2-1: BUSY conditions, also refer to "Busy State" (page 3-10).



Note:

Do not change DIP switch settings 2-2 and 2-6. Doing so may cause the printer to malfunction.

Table 2-5 Print density selection (DIP SW2-3, 2-4)

Print density		Switch No.	
		2-3	2-4
Print density	Low power consumption mode	ON	ON
Print density	Standard*	OFF	OFF
Print density	More dark than standard	ON	OFF
Print density	More dark	OFF	ON



Note:

- Turn off the power before changing the DIP switch settings.
- DIP switch settings are enabled only when the power is turned on or the printer is reset via the interface. If the settings are changed after that, the functions will not change.
- If the print density is set to More dark than standard or More dark, printing speed may slow down.

2.2.2.2 DIP switch settings for other interface specifications

The following DIP switch functions are for parallel interface/USB/Ethernet/Wireless LAN model printers.

**Note:**

* Factory setting

Table 2-6 Parallel/USB/Ethernet/Wireless LAN DIP switch bank 1

SW	Function	ON	OFF	DEFAULT
1-1	Automatic line feed	Enabled at all times	Disabled at all times *	OFF
1-2	Receive buffer size	45 bytes	4KB *	OFF
1-3	Reserved (Always use printer with these switches set to OFF.)	—	—	OFF
1-4	Error signal output	Disabled	Enabled	OFF
1-5 ~ 1-8	Reserved (Always use printer with these switches set to OFF.)	—	— *	OFF

Table 2-7 Parallel/USB/Ethernet/Wireless LAN DIP switch bank 2

SW	Function	ON	OFF	DEFAULT
2-1	Handshake (BUSY conditions)	• Receive buffer full	• Offline * • Receive buffer full	OFF
2-2	Reserved (do not change setting)	Fixed to OFF		OFF
2-3, 2-4	Print density selection/low-power mode	(See separate table.)		OFF
2-5	Reserved (Always use printer with these switches set to OFF.)	—	—	OFF
2-6, 2-7	Reserved (do not change setting)	Fixed to OFF		OFF
2-8	Pin #31 reset signal (do not change setting)	Fixed to ON		ON

DIP SW2-1: For details on the BUSY condition, also refer to "Busy State" (page 3-10).

**Note:**

Do not change DIP switch settings 2-2 and 2-6. Doing so may cause the printer to malfunction.

Table 2-8 Selection of print density

Print density		Switch No.	
		2-3	2-4
Print density	Low power consumption mode	ON	ON
Print density	Standard*	OFF	OFF
Print density	More dark than standard	ON	OFF
Print density	More dark	OFF	ON

**Note:**

- Turn off the power before changing the DIP switch settings.
- DIP switch settings are enabled only when the power is turned on or the printer is reset via the interface. If the settings are changed after that, the functions will not change.
- If the print density is set to More dark than standard or More dark, printing speed may slow down.

2.3 Connecting the Printer to the Host Computer

2.3.1 Serial Interface Connection

2.3.1.1 Cross cable wiring diagrams

The wiring selections for available serial cross cables are as follows:

Type A

D-Sub 25P(TM)			D-Sub 9P(PC)	
Pin No	Signal		Signal	Pin No
1	FG		DCD	1
2	TXD		TXD	3
3	RXD		RXD	2
20	DTR		DTR	4
6	DSR		DSR	6
4	RTS		RTS	7
5	CTS		CTS	8
7	GD		GD	5
25	RESET		RI/RESET	9

Type B

D-Sub 25P(TM)			D-Sub 9P(PC)	
Pin No	Signal		Signal	Pin No
1	FG		DCD	1
2	TXD		TXD	3
3	RXD		RXD	2
20	DTR		DTR	4
6	DSR		DSR	6
4	RTS		RTS	7
5	CTS		CTS	8
7	GD		GD	5
25	RESET		RI/RESET	9

Figure 2-12 Cross cable diagrams

The cable needed depends on printer control and handshake method. You can operate the TM printer with a Windows driver, OPOS, or ESC/POS commands. XON/XOFF, DTR/DSR, or RTS/CTS are available as handshake controls. For details on available cables for each connection form, refer to "Section 2.3.1.2, Serial interface connection diagrams."

2.3.1.2 Serial interface connection diagrams

When the TM printer is connected to a host computer by the serial interface, the following two connection forms are possible:

- Stand alone
- Pass-through connection

Stand alone

Both the TM printer and DM-D are connected to the host computer directly via the serial port.

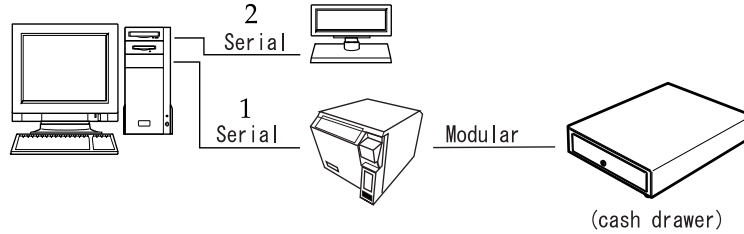

Application control		XON/XOFF (except OPOS)	DTR/DSR (DOS, OPOS, Visual C)	RTS/CTS (DOS, Windows driver, Visual C, Visual Basic MSComm)
TM side control setting	XON/XOFF	1	Type A or B	—
		2	DM-D500: A, B Other DM-D: not possible	—
DTR/DSR		1	—	Type B
		2	—	Type B

Figure 2-13 Configuration of stand-alone connection

Pass-through connection

The host computer is connected to the TM printer over the serial interface via DM-D.

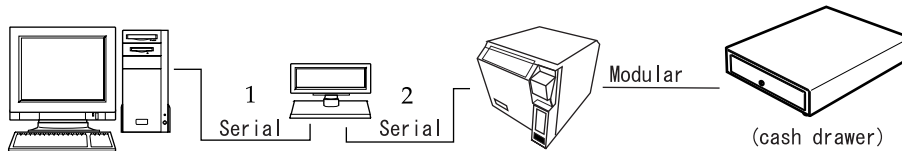

Application control		XON/XOFF (except OPOS)	DTR/DSR (DOS, OPOS, Visual C)	RTS/CTS (DOS, Windows driver, Visual C, Visual Basic MSComm)
TM side control setting	XON/XOFF	Not possible		—
	DTR/DSR	1	—	Type B
	2	—	Type A or B	Type A or B

Figure 2-14 Configuration of pass-through connection

2.3.1.3 Connecting the serial interface (RS-232) cable

WARNING:

Be sure to turn off the power supply for both the printer and host computer before connecting the cables.

1. Insert the interface cable connector firmly into the interface connector on the connector panel.
2. When using connectors equipped with screws, tighten them to secure the connectors firmly.

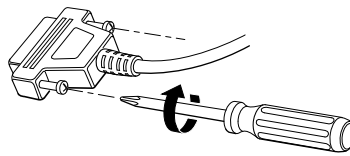

3. When using interface cables equipped with a ground line, attach the ground line to the screw hole marked "FG" on the printer.
4. Connect the other end of the interface cable to the host computer.

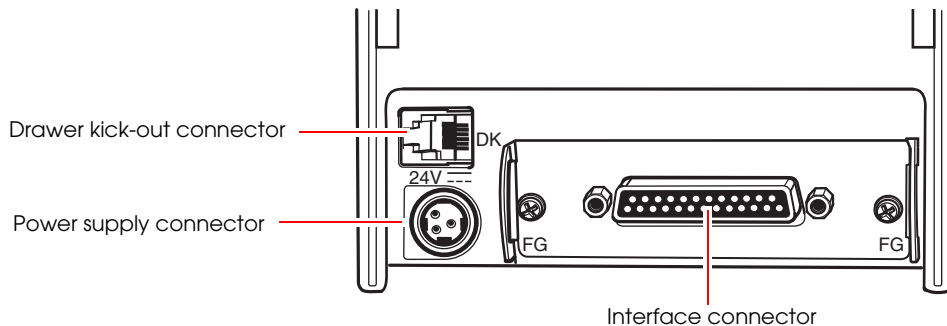

Figure 2-15 Printer connectors

2.3.2 Parallel Interface Connection

The parallel interface model TM printer is connected to the host computer via the parallel port. When a customer display (DM-D) is to be connected, connect the TM printer to the host computer via the serial port.

2.3.2.1 Parallel interface connection diagram

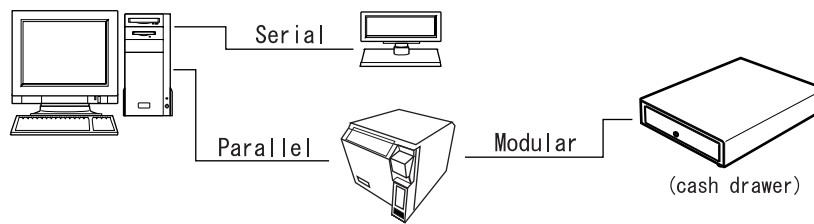

Figure 2-16 Parallel interface connection

2.3.2.2 Connecting the parallel interface cable

1. Insert the interface cable connector firmly into the interface connector on the connector panel.
2. Press down the clips on either side of the connector to lock it in place.
3. When using interface cables equipped with a ground line, attach the ground line to the screw hole marked "FG" on the printer.
4. Connect the other end of the interface cable to the host computer.

2.3.3 USB Interface Connection

Connect the TM printer to the host computer with a USB cable. A second TM printer can be connected via a self-powered USB hub from a printer connected to the host computer.



Note:

A customer display (DM-D) can be connected to a USB model TM-T70 (with UB-U01III/UB-U02III) by the exclusive modular cable (RJ-45). When connecting the customer display, connect the modular jack from the customer display to the DM connector (refer to "Installing the locking wire saddle" (page 2-11)).

When connecting the customer display to a USB model TM-T70 (with UB-U01III/UB-U02III), set the communication conditions of the customer display as follows:

- Baud rate:19200 bps
- Bit length:8-bit
- Parity:no parity
- Stop bit:1

2.3.3.1 USB Interface Connection Diagram

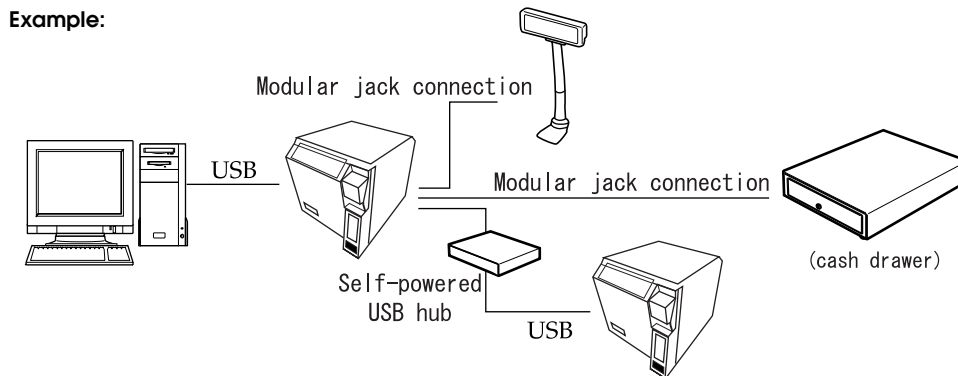

Figure 2-17 USB connection

2.3.3.2 Connecting the USB interface cable

1. Attach the locking wire saddle at the location shown in the figure below.
2. Put the USB cable through the locking wire saddle as shown in the figure below.

 **Note:**

Putting the USB cable through the locking wire saddle, as shown in the figure below, prevents the cable from coming unplugged.

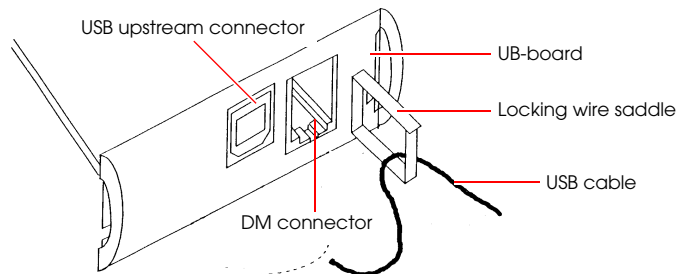

Figure 2-18 Installing the locking wire saddle

3. Connect the USB cable from the host computer to the USB upstream connector.

 **Note:**

The hub installed in a USB model connector panel is a bus-power-supply hub.(UB-U01III only). It is important to note that bus-power-supply hubs (including other USB model TM printers) and bus-power-supply functions with a current consumption of 100 mA or more cannot be connected directly to the printer.

To use USB model TM printers, the TM printer driver (EPSON OPOS ADK or advanced printer driver) must be installed on the host computer. Get the latest driver information from one of the following URLs:

For customers from North America, go to the following web site:

<http://pos.epson.com/>

For customers from other countries, go to the following web site:

<http://www.epson-pos.com/>

Select the product name from the "Select any product" pull-down menu.

For details on EPSON OPOS ADK or advanced printer driver, refer to "Introducing the Control Methods" (page 3-1).

2.3.4 Ethernet Interface Connection

Connect a TM printer with an Ethernet interface to a network by an Ethernet cable via a hub.

2.3.4.1 Ethernet Interface Connection Diagram

Example:

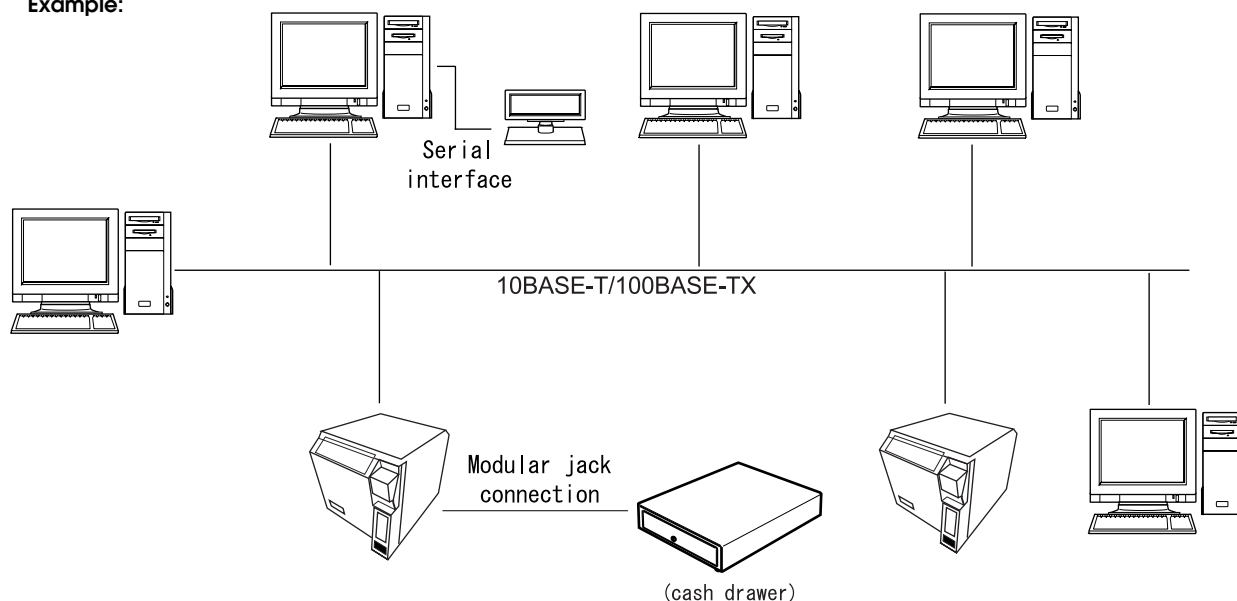

Figure 2-19 Ethernet connection

2.3.4.2 Connecting the Ethernet Interface Cable

1. Make sure the power supplies for both the printer and host computer have been turned off.
2. For 10BASE-T/100BASE-T Ethernet, connect a 10BASE-T/100BASE-T cable to the 10BASE-T/100BASE-T Ethernet connector by pressing firmly until the connector clicks into place.

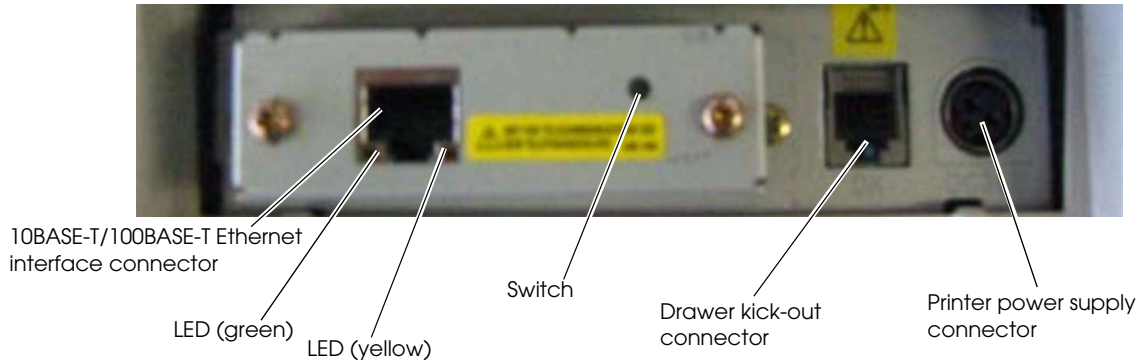

Figure 2-20 Example Ethernet port interface panel (UB-E02)

CAUTION:

Connecting devices directly to LAN cables installed outdoors exposes them to damage from power surges caused by lightning and other inductive sources. Make sure devices without proper surge protection are cushioned by being connected through devices that do have surge protection. Otherwise, do not connect them to outdoor lines.

Never attempt to connect the customer display cable, drawer kick-out cable, or the standard telephone line cable to the 10BASE-T/100BASE-TX Ethernet connector.

Note:

To use the Ethernet interface, the separate IP Address Setup Utility for the UB-E02 is required. For details on the various setup methods, refer to “UB-E02 Technical Reference Guide.” You can obtain the “IP Address Setup Utility for UB-E02” and the “UB-E02 Technical Reference Guide” from one of the following URLs:

For customers from North America, go to the following web site:

<http://pos.epson.com/>

For customers from other countries, go to the following web site:

<http://www.epson-pos.com/>

Select the product name from the “Select any product” pull-down menu.

Other compatible Ethernet interface modules may be available for your printer. Contact your EPSON dealer for information on the options available.

2.3.5 Wireless LAN Interface Connection

For details on how to set up a wireless LAN interface, see the UB-R02 Technical Reference Guide.



Note:

To use the Wireless LAN interface, the separate IP Address Setup Utility for the UB-E02 is required. For details on the various setup methods, refer to “UB-E02 Technical Reference Guide.” You can obtain the “IP Address Setup Utility for UB-E02” and the “UB-E02 Technical Reference Guide” from one of the following URLs:

For customers from North America, go to the following web site:

<http://pos.epson.com/>

For customers from other countries, go to the following web site:

<http://www.epson-pos.com/>

Select the product name from the “Select any product” pull-down menu.

Other compatible Ethernet interface modules may be available for your printer. Contact your EPSON dealer for information on the options available.

2.4 Connecting Power Supply Unit and Cash Drawer

Always use one of the following power supplies:

The EPSON PS-180 (the currently available power supply that can be used with the TM-T70).

Use the cash drawer handled by EPSON or your dealer.



WARNING:

Always use the EPSON PS-180 or an equivalent product as the power supply unit. Using a nonstandard power supply can result in electric shock and even fire.

Should a fault ever occur in the EPSON PS-180, or equivalent product, immediately turn off the power to the printer and remove the power supply cable from the wall socket.

2.4.1 Connecting the Power Supply Unit

1. Make sure the printer’s power supply is turned off and the power supply unit’s power cable has been removed from the wall socket.
2. Check the specifications label on the power supply unit to confirm that the wall socket power supply meets the rated voltage requirements.

3. Insert the connector of the power supply cable onto the power supply connector (labeled **DC24V**).

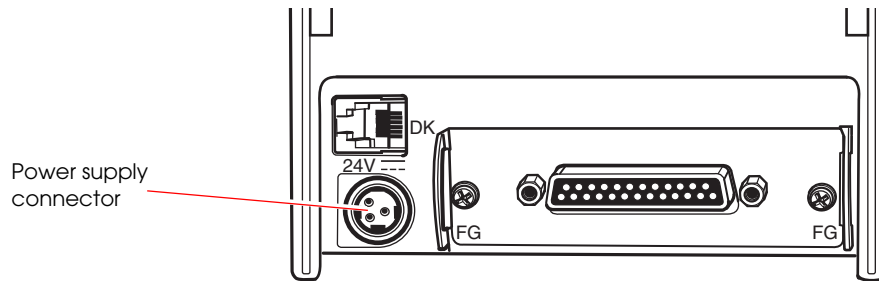

Figure 2-21 Connecting the power supply

⚠ CAUTION:

Be sure to remove the power supply unit's cable from the wall socket whenever connecting or disconnecting the power supply unit to the printer. Failure to do so may result in damage to the power supply unit or the printer.

Make sure the wall socket power supply satisfies the rated voltage requirements of the power supply unit. Never insert the power supply cable plug into a socket that does not meet the rated voltage requirements of the power supply unit. Doing so may result in damage to both the power supply unit and the printer.

✎ Note:

Before removing the DC cable connector from the EPSON PS-180 (current model power supply), make sure the power supply cable has been removed from the power supply unit, then grasp the arrow-marked section of the connector and pull straight out.

2.4.2 Connecting the Drawer Kick-out Cable

⚠ WARNING:

Prepare a drawer that meets printer specifications. Otherwise, the drawer kick-out solenoid or other parts in the drawer might burn and cause a fire. This may also cause the printer to malfunction at the same time.

Do not insert a telephone line into the drawer kick-out connector. Doing so may damage the telephone line or printer.

Connect the connector of the drawer kick-out cable to the printer.

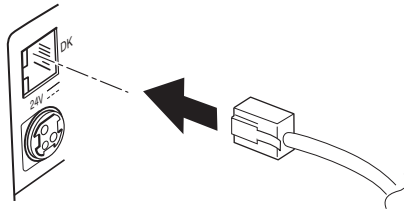

Figure 2-22 Connecting the drawer-kick cable

2.5 Installing the Driver

To use the TM printer, either the Advanced Printer Driver (APD) (Windows driver) or the EPSON OPOS ADK (OCX driver) must be installed. For an outline of each driver, refer to “Introducing the Control Methods” (page 3-1). For details on installation methods, refer to the manual for the respective driver.



Note:

ESC/POS commands are also available for directly controlling the printer without the user of a driver. For details on ESC/POS commands, also refer to “ESC/POS Commands” (page 3-6).

Chapter 3

Application Development Information

This chapter describes how to control the printer and gives information useful for printer application development.

3.1 Introducing the Control Methods

The TM printer can be controlled and can print using any of the following 3 methods.

1. Windows printer driver (EPSON Advanced Printer Driver or APD)
2. EPSON OPOS ADK
3. ESC/POS commands

Depending on the driver and interface used, the IP setup tool for the Ethernet model, USB device driver, logo printing registration utility (TMFlash logo utility), etc. are available. Get the latest information from one of the following URLs:

For customers from North America, go to the following web site:

<http://pos.epson.com/>

For customers from other countries, go to the following web site:

<http://www.epson-pos.com/>

Select the product name from the "Select any product" pull-down menu.

3.1.1 Windows Driver (EPSON Advanced Printer Driver)

The EPSON Advanced Printer Driver provides the TM printer with satisfactory control as a Windows driver.

3.1.1.1 EPSON Advanced Printer Driver overview

EPSON Advanced Printer Driver has the following features:

- ❑ Supplies a Windows printer driver for the TM printer to enable printing from a general Windows application.
- ❑ Can execute POS printer-specific functions, such as cutting paper and opening a drawer.
- ❑ Can print printer-resident fonts by selecting the font type.
- ❑ Can get the printer status using programming languages, such as Visual Basic (VB), via status API. This uses the printer's bidirectional communication capability in the Windows standard printer driver operating environment.



Note:

The status API is a printer control API originally supplied by EPSON. This can be used to get the printer status and send ESC/POS commands.

3.1.1.2 EPSON Advanced Printer Driver contents

The installer automatically evaluates the target PC environment and automatically installs the DLL and software components necessary for operation. You can select the drivers, sample programs, and manuals to be installed.

❑ Drivers

You can select the driver, based on its purpose (drivers also can be installed simultaneously), including smoothing, continuous printing, cutting method options, and other functions.

- Receipt: For receipt printing
- Reduce35: By reducing A4 portrait size by 35%, it is possible to print at 80 mm receipt width.

❑ Sample programs

You can install sample programs in Visual Basic and Visual C++ to use status API.

❑ Manuals

The following manuals can be installed:

- User's manual (for developers)
- Engineering data for each status
- Main function control methods (for WordPad and VB)

3.1.1.3 EPSON Advanced Printer Driver support environment

❑ Supported interfaces

- Serial, parallel, USB, Ethernet

❑ Supported operating systems (with confirmation of system operation)

- Microsoft Windows NT4.0 SP6a English
- Microsoft Windows 2000 SP4 English
- Microsoft Windows XP SP2 English
- Microsoft Windows XP Embedded

Refer to the release note for the driver for the latest information.

❑ Supported development languages

- Visual Basic
- Visual C++

❑ Supported devices

Refer to the release note for the driver for details on available equipment.

- EPSON receipt printer
- EPSON customer display
- EPSON cash drawer



Note:

A separate USB device driver is required for a USB model printer, and a separate IP setup utility is required for an Ethernet model printer. See the manual packed with the APD.

When you use the APD for the TM-T70, using TrueType fonts may slow printing down, due to the speed of communication between the printer and host computer. If this happens, we recommend using printer-resident fonts. For details on how to use resident fonts, see the user's manual for the APD.

Printing with TrueType fonts on other interfaces may have a slight influence on customer applications. In that case, use the printer-resident fonts. Because of the restrictions of some customer applications, when the APD is used with that application, resident fonts sometimes cannot be used, even if they are specified.

When OPOS is used, this problem does not arise because only the printer-resident fonts are available.

3.1.1.4 Driver information and download destination

Get the latest driver information from one of the following URLs:

For customers from North America, go to the following web site:

<http://pos.epson.com/>

For customers from other countries, go to the following web site:

<http://www.epson-pos.com/>

Select the product name from the "Select any product" pull-down menu.

3.1.2 EPSON OPOS ADK

The EPSON OPOS ADK supports the development environment required for OPOS application development using OPOS Control as described by the Open Point of Service (simply called "OPOS" from here on) Technology Association to supply the OPOS-compliant printer driver (OCX). Use this control method to develop OPOS-compliant applications. EPSON's OPOS ADK has the following features:

- ❑ The EPSON OPOS ADK comprehensively supports the development environment required for OPOS application development at customer sites, including not only OPOS Control (CO + SO) proposed by the OPOS Association, but also the contents necessary for development, ranging from the installers and setup utilities to sample programs and manuals, and the function for getting logs for debugging, and silent installation that achieves ease of installation on a target PC.

- ❑ The EPSON OPOS ADK reduces the man-hours for application development, since it handles the following functions that application developers up till now have had to consider. The functions are supported by EPSON-original Direct IO with parameters, power-on notification, offline buffer clear processing, and so on.



Note:

For details on the API functions, refer to the “Application Programmers Guide Specification” provided by the OLE POS Technology Association.

3.1.2.1 EPSON OPOS ADK (OPOS Control) overview

OPOS Control included with the EPSON OPOS ADK has the following features:

- ❑ Supplies the CO for each device class and SO for EPSON devices.
- ❑ Direct IO with parameters available:
 - Gets the printer maintenance counter value
 - Prints NVRAM-stored bit images, etc.
- ❑ Power-on notification function (at power on, this function automatically restores the printer to the state that was active before power off).
- ❑ Offline buffer clear processing (clears the print buffer contents in offline mode).
- ❑ Debugging function (trace function):
 - Obtains a log between the application and CO (target: used API and its return value)
 - Device status acquisition log (gets the offline and error causes that actually occurred in the devices)

3.1.2.2 EPSON OPOS ADK contents

The installer of the EPSON OPOS ADK, Ver. 2.10 or later, has a silent installation function, which can install the OPOS environment without a user interface and facilitate installation. With the installer, the following OPOS-compliant OPOS Control for EPSON devices, manuals, various utilities, and sample programs can be installed.

- ❑ OPOS Control for EPSON devices

Header files for CO, SO, C++, header files for VB, TLB file of CO, device information files, etc., can be installed.

- ❑ Manuals
 - User's guide (environment construction manual: installation/uninstallation, usage methods for various utilities)
 - Application Development Guide (manual for OPOS-compliant application developer: common manual, manual for each device)

- ❑ Various utilities
 - SetUpPOS utility
Facilitates selection of equipment and connection ports and various settings (print wait time, etc.).
 - TM Flash logo utility
Saves a bitmap file to the printer or customer display, for example.
 - USB device driver
This driver is necessary to connect a USB model printer.
 - Sample programs
Sample programs for VB, VC++ can be installed.

3.1.2.3 EPSON OPOS ADK support environment

- ❑ Supported interfaces
 - Serial, parallel, USB, Ethernet
- ❑ Supported OSeS (with confirmation of system operation)
 - Windows 95 Standard, OSR 2.5
 - Windows 98 Second Edition
 - Windows NT Ver. 4.0 SP5, SP6
 - Windows 2000 Professional
 - Windows XP Professional

Refer to the release note of the driver for the latest information.

- ❑ Supported development languages
 - Visual Basic
 - Visual C++

3.1.2.4 Driver information and download destination

Get the latest driver information from one of the following URLs:

For customers from North America, go to the following web site:

<http://pos.epson.com/>

For customers from other countries, go to the following web site:

<http://www.epson-pos.com/>

Select the product name from the “Select any product” pull-down menu.

3.1.3 ESC/POS Commands

To directly control the TM printer using ESC/POS commands, EPSON proposes printing/control via ESC/POS commands. The printer can be controlled directly by sending ESC/POS commands from an application to the printer. For detailed information about ESC/POS commands, please contact EPSON or your dealer.

3.1.4 Various Utilities

We provide the utilities described below for developers of TM printer applications. You can obtain the utilities from one of the following URLs:

For customers from North America, go to the following web site:

<http://pos.epson.com/>

For customers from other countries, go to the following web site:

<http://www.epson-pos.com/>

Select the product name from the “Select any product” pull-down menu.

3.1.4.1 Memory Switch Setting Utility

This utility is designed to perform the memory switch-related functions of the TM printer easily.

- You can execute a communication test and self-test.
- You can set the switches, etc. (such as customized values and serial communication condition).

3.1.4.2 IP address setup utility for UB-E02

This utility and its detailed manual for developers allow you to set an IP address for a 10BASE-T/100BASE-TX Ethernet interface installed in the TM printer. Customers who have purchased the Ethernet model TM printer need this utility.

3.1.4.3 IP address setup utility for UB-R02

This utility and its detailed manual for developers allow you to set an IP address for a Wireless LAN interface installed in the TM printer. Customers who have purchased the Wireless LAN model TM printer need this utility.

3.1.4.4 TM Flash logo utility

This utility is designed to save logos (bitmaps) to NVRAM (non-volatile RAM). By storing shop logos to NVRAM, the print speed can be increased.

3.2 Switches and Buttons

On this printer, you can disable or enable the FEED button. For details on how to switch between disabled or enabled, refer to the documentation for OPOS Advanced Printer Driver and ESC/POS commands, respectively.

3.2.1 FEED Button

The printer feeds paper based on the line spacing set by the control method (OPOS, Advanced Printer Driver, ESC/POS commands). However, you cannot feed paper using the FEED button under the following conditions:

- When the roll paper cover is open.
- When performing a self-test (Press the FEED button to stop the self-test and press it again to resume it).

3.3 Panel LEDs and Error Status

3.3.1 (POWER) LED

Table 3-9 Power LED

Item		Specifications
LED color		Green
LED states	Off	Power is not supplied.
	On	Power is supplied.

3.3.2 PAPER OUT LED

Table 3-10 PAPER OUT LED

Item		Specifications
LED color		Red
LED states	Off	Roll paper is loaded.
	On	A roll paper near end or paper end is detected.
	Flashing	Self-test standby state or standby state when a macro execution command is used.

3.3.3 Error LED

Table 3-11 Error LED

Item		Specifications
LED color		Red
On states	Off	Printer is performing regular operations or is online.
	On	Offline (excluding self-test with the FEED button).
	Flashing	Error state.

3.3.3.1 Error Codes

There are three possible error types: automatically recoverable errors, recoverable errors, and unrecoverable errors.



- ❑ For automatically recoverable errors, the user does not have to take any action. The error recovers automatically when the head temperature returns to normal or the cover is correctly closed.

- ❑ A recoverable error recovers by resetting the printer or sending a command from the driver after the cause of the error is eliminated.
- ❑ For unrecoverable errors, the printer or the power supply may be malfunctioning and must be repaired.

Automatically recoverable errors

Although normal printer operation is no longer possible when automatically recoverable errors occur, they do not represent printer failure. They can be recovered easily, as described below.

Table 3-12 Automatically recoverable errors

Error	Error description	Error LED flash code	Recovery measure
		 Approx. 160 ms	
Roll paper cover open error	The roll paper cover was opened during printing.		Recovers automatically when the roll paper cover is closed.
Print head temperature error	A high temperature outside the head drive operating range was detected.		Recovers automatically when the print head cools.



Note:

If the temperature cannot be detected correctly, an internal circuit connection error occurs.

Recoverable errors

Although normal printer operation is not possible after a recoverable error occurs, this is not a printer malfunction. These errors can be recovered easily by turning the power on again or sending an error recovery command from the driver after eliminating the cause of the error.

Table 3-13 Recoverable errors

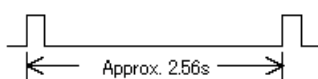
Error	Error description	Error LED flash code	Recovery measure
		 Approx. 160 ms	
Autocutter error	Autocutter does not work correctly.	 Approx. 2.56s	Remove the jammed paper or foreign matter in the printer, close the roll paper cover, send the error recover command, or turn the power on to recover.









Note:

The error recovery command is valid only if a recoverable error (excluding automatically recoverable errors) occurs. If a recoverable error occurs, the printer recovers from the error upon receipt of an error recovery command from the driver after the cause of the error is eliminated. Turning the printer's power off and on is not required.

Unrecoverable errors

Normal printer operation is no longer possible when unrecoverable errors occur. The printer must be repaired.

Table 3-14 Unrecoverable errors

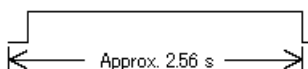
Error	Error description	Error LED flash code	Recovery measure
			
Memory R/W error	After R/W checking, the printer does not work correctly.		Impossible to recover
High voltage error	The power supply voltage is extremely high.		Impossible to recover
Low voltage error	The power supply voltage is extremely low.		Impossible to recover
CPU execution error	The CPU is executing an incorrect address.		Impossible to recover
UIB Error	An abnormal operation occurs in UIB.		Impossible to recover
Internal circuit connection error	Internal circuits are not connected correctly.		Impossible to recover

 **Note:**

When an unrecoverable error occurs, turn off the power supply immediately.

3.4 Sensors

3.4.1 Paper Sensors

The printer has two paper sensors.

3.4.1.1 Roll paper near-end sensor

The roll paper near-end sensor uses the diameter of the roll paper to detect whether the remaining paper is getting low. This sensor is located inside the roll paper supply unit, and you can fine-tune the amount of remaining paper detected by this sensor.

Lighting of the PAPER OUT LED in a near-end state does not indicate an error. Regular printing is possible.

 **Note:**

Detection of the near-end status does not necessarily indicate the complete end of the roll paper. Use the sensor as an indication of when to replace the roll paper.

By changing the driver setting, a print job can be canceled automatically during the near-end status.

3.4.1.2 Roll Paper End Sensor

The roll paper end sensor detects whether there is paper in the paper path. When there is no paper (paper end status), the PAPER OUT LED and ERROR LED light to indicate an error has occurred. If the sensor detects a roll paper end, the printer stops printing, even in the process of printing. We recommend that you mainly rely on the roll paper near-end sensor and use the roll paper end sensor secondarily.

3.4.2 Printer Cover Sensor

3.4.2.1 Roll Paper Cover Open Sensor

The cover-open sensor monitors the roll paper cover. When the sensor detects an open cover during printing, the printer stops printing immediately.

This status is treated as an automatically recoverable error, and the ERROR LED flashes. When the printer cover is closed, the ERROR LED goes out, and starts printing at the beginning of the line it was printing when the cover was opened.

When the printer recovers, it feeds paper to take up slack and starts printing from the beginning of the line where the error occurred. In this case, double printing and printing position shift may occur. When a cover open error occurs, we recommend clearing the printer's print buffer by sending the error recovery command from the driver, and resending the print data.



Note:

Whether the cover is open or not does not affect the status reported by the roll paper end sensor.

3.4.3 Offline

This printer is not equipped with an online/offline switch. The printer automatically goes offline under the following conditions:

- During power on (including resetting with the interface) until the printer is ready
- During the self-test
- When the roll paper cover is open
- During paper feeding using the FEED button
- When the printer stops printing due to a paper-end (if an empty paper supply is detected by the roll paper end sensor or if the driver has been set to stop printing when a roll paper near-end is detected)
- When an error has occurred

3.4.4 Busy State

3.4.4.1 Selecting conditions for invoking a BUSY state

With DIP SW2-1, you can select conditions for invoking a BUSY state as either of the following:

- When the receive buffer is full
- When the receive buffer is full or the printer is offline

 **Note:**

In either case above, the printer enters the BUSY state after power is turned on (including resetting with the interface), and when a self-test is being run.

For details on how to change the DIP switch setting for receive buffer full, see “Setting the DIP Switches” on page 2-3.

When using the Advanced Printer Driver, DIP SW2-1 must be ON. When using OPOS, it can be either ON or OFF.

Table 3-15 Printer BUSY conditions and status of DIP SW2-1

Printer status		DIP SW2-1 status	
		ON	OFF
Offline	During the period after power is turned on (including resetting with the interface) to when the printer is ready to receive data.	BUSY	BUSY
	During the self-test.	BUSY	BUSY
	When the cover is open.	—	BUSY
	During paper feed with the FEED button.	—	BUSY
	When the printer stops printing due to a paper-end (when printer has run out of roll paper).	—	BUSY
	When an error has occurred.	—	BUSY
When the receive buffer is full		BUSY	BUSY

 **Note:**

When DIP SW2-1 is ON, the printer will not become BUSY.

- When an error has occurred
- When the cover is open
- When printing has stopped for a paper out
- When paper is fed by the FEED button

3.5 NVRAM (Non-volatile Memory)

NVRAM is mounted on this printer, and bitmap images (for example, business logos) or other data are written to it. Pay attention to the following when using NVRAM.

- ❑ The following restriction applies when performing operations (including storing and deleting data) in NVRAM.
 - Do not use the FEED button.
- ❑ The printer sometimes enters the BUSY state when data is being written to NVRAM. It is important not to send data from the host computer while the printer is in the BUSY state, because the printer cannot process any received data. Also, do not turn off the printer.
- ❑ Frequent use of the functions for writing data to and deleting data from NVRAM may damage the memory. As a rule, in using the various commands to write to NVRAM, avoid writing more than an average of ten times per day.

3.6 Bar Code Printing

This printer can print the following types of bar codes:

UPC-A, UPC-E
JAN 8 (EAN 8), JAN 13 (EAN 13)
CODE 39
ITF (Interleaved 2 of 5)
CODABAR (NW-7)
CODE 93
CODE 128
PDF417 (2D code)
QR Code

To set and print each bar code, refer to the OPOS, Advanced Printer Driver, and ESC/POS command documentation, respectively.



Note:

Take a consideration as described below to determine whether the ability of the reader (scanner) can be satisfied when the print result on the receipt, such as bar code, 2-dimensional code, or characters.

- Print density
The print density may vary depending on the type of roll paper or the environmental conditions.

3.7 Notes on Printing 2-Dimensional Code

The TM-T70 supports 2-dimensional code printing. Be sure to follow the notes below when printing 2-dimensional codes.

1. Provide the quiet zone according to the code specifications by the user.
2. When printing PDF417 (2-dimensional code), it is recommended to set the height of one module of the symbol to three to five times the width of one module, also making sure that the total height is almost 5 mm {0.20"} or more.

The recognition rate of the ladder bar code or 2-dimensional code may be affected by such items as different widths of the modules, print density, environmental temperature, type of the thermal paper, and characteristics of the reader. Therefore, the user should check the recognition rate in advance so that the limitations of the reader can be considered.

3.8 Operating Mode (Switch Panel Operation)

The printer has a self-test mode to check printer settings in addition to the regular print mode.

3.8.1 Self-test Mode

In the self-test mode, the following items are checked and printed out:

- Control circuit functions

- Printer mechanism functions
- Print quality
- Control software ROM version
- DIP switch settings

This test is independent of any other equipment or software, so it is a good idea that run it when you first set up the printer and if you have any trouble. If the self test works correctly, the problem is in the other equipment or the software, not the printer.

Follow the steps below to start a self-test:

1. With the roll paper cover open, press and hold down the FEED button and turn on the printer. The printer prints various printer settings.
2. When the printer finishes printing the printer status, check whether the following message is printed (The printer is now in the self-test wait mode.) :

**"If you want to continue SELF-TEST printing.
Please press FEED button"**

3. To start a test print, press the FEED button while the printer is in the self-test wait mode.
4. Check that the following has been printed:

***** completed ***"**

This indicates that the printer has been initialized and returned to the normal mode.



Note:

With the Ethernet specification, it takes 6 seconds if the IP address is fixed, and 13 seconds if it is acquired with automatic setting. (It may take longer depending on the response time from the host.) Please note it in advance.

3.9 FAQ List

Listed here are the most-asked questions (Q) and answers (A).

1. Look for information relating to your inquiry or problem in the questions.
2. Then, follow the instructions described in the "A" sentence below it.

3.9.1 Q: Why has my print data dropped out?

A: Check the handshake process. Data dropout can occur when the handshake between the host computer and printer is not performed correctly. This can result in errors related to print buffer size.

3.9.1.1 Corrective procedure

1. Check the serial communication cable, and check the cable connector specifications. (See "Serial Interface Connection" on page 2-7.)

2. Check the serial communication conditions of the printer and the host.

Serial communication conditions

- Baud rate
- Parity
- Flow control
- Data length

You can check printer settings as follows:

1. Run a self-test to check the printer's serial communication conditions. (See page 3-12.)
2. Setting communication conditions using the DIP switches. Set the baud rate with DIP SW1-7 and SW1-8. (Refer to page 2-4.)

3.9.2 Q: Why does the drawer kick-out not operate properly?

A: Drawer specifications differ depending on the manufacturer and the part number. Make sure the specifications of the drawer to be used meet the following conditions before connecting it to the drawer kick-out connector. These conditions also apply to any other devices that use the drawer kick-out connector. Any devices that do not satisfy all the following conditions must not be used.

Conditions

- A load must be provided across drawer kick-out connector pins 4 and 2 or across pins 4 and 5. (*1)
- When the drawer open/close signal is used, a switch must be provided across drawer kick-out connector pins 3 and 6. (*2)
- The solenoid used for the cash drawer must have a resistance of 24 Ω or higher. (*3)

NOTES

- (*1) Operating the printer with incorrectly installed devices voids the warranty.
- (*2) Connecting devices other than the drawer open/close switch voids the warranty.
- (*3) Using a drawer or a drawer kick-out connector with an input current of 1 A or more may cause an over current, which will cause the device to malfunction.

3.9.3 Q: I cannot print part of Page 0 in Visual Basic. Why?

Cannot print a part of Page 0 (for example: **ä, ú, ë**) in Visual Basic.

A: Try printing using the following procedure:

When programming with Visual Basic, limitations prevent data from 81H through 9FH and from E0H through FEh from being sent as characters. However, you can use the following procedure to send this data:

```
Dim Send_data(0) As Byte  
Send_data(0) = &h81 '1 byte of sending data  
MSComm1.Output = Send_data
```

Chapter 4

ESC/POS Command-related Information

This chapter introduces the printer operation settings, which can be made by using ESC/POS commands, and precautions for those operation settings.

4.1 NV Memory (Non-volatile Memory)

The printer's NV memory can be roughly divided into three parts:

- Firmware program area
- NV memory area for product information (This area cannot be edited by the user.)
- NV memory area that the user can access

The following areas are in the NV memory that the user can access:

- NV user memory
- NV graphics memory
- User-defined character code page ("C.11 Page 255 (Blank Page)")
- Area of user-defined command default values

You can customize your printer by changing these values. Note the following when writing to and deleting from NV memory.

- ❑ The following restrictions apply when performing non-volatile memory operations (including data writing and deleting).
 - Do not press the FEED button.
 - Do not turn off the power.
 - Do not execute a real-time command.
 - The ASB status is not sent, even when the ASB function in ESC/POS commands is set to **Enabled**.
- ❑ The printer sometimes enters the BUSY state while data is written to NV memory. It is important not to send data from the host computer while the printer is BUSY, because the printer cannot process any received data.
- ❑ Frequent use of the functions for writing data to and deleting data from NV memory may damage the memory. As a rule in using the various commands to write to NV memory, avoid writing more than an average of ten times per day.

4.1.1 Using NV Memory

You can use the free area in NV memory for writing memos, for other character information, for anything you like. Data written to this area is held in the memory even if you turn off the power. For details on how to read and write data, see the "ESC/POS Application Programming Guide."



Note:

For details on NV graphics and NV bit images, see the “ESC/POS Application Programming Guide.”

4.2 Printer Status

There are three ways to get the printer status, and each method has the following features. For details, see the “ESC/POS Application Programming Guide.”

- **Automatic status back (ASB):**
When a status request is processed as a regular command, the printer automatically returns a status message whenever the status changes. Always monitor the value returned.
- **Real-time status:**
When the printer receives a real-time status command, it responds with the specified printer status. Returning the printer status takes priority over any regular print data.
- **Status:**
The printer transmits a specified printer status in the same way it processes normal print data.

4.3 Precautions When the Printer Is Offline

When printer handshake is set with DIP SW2-1 ON (BUSY = receive buffer full), use the ASB function to check the printer status. Using the ASB lets the printer send status automatically at the time of switching online/offline. When using a real-time command, make sure the receive buffer is not full.

Example: After using the 4KB receive buffer to send data for each line, check the printer status.

4.4 Outputting Hex Dumps

TM printers can print data transmitted from the host computer as hexadecimal numbers and their corresponding characters. Called “hex dump mode,” this allows you to make sure that data has been sent correctly to the TM printer by comparing the printed result with the program. Follow the steps below to output a hex dump:

1. With the roll paper cover open, turn power on while holding down the FEED button.
2. Close the roll paper cover.
3. Data received from then on is printed out from the TM printer in hexadecimal numbers and their corresponding characters.

To quit the hex dump mode, turn the printer off or press FEED button three times.



Note:

Do not use this mode when using OPOS or the APD. Doing so will cause unexpected data to be printed, because the driver uses proprietary control to drive the printer.

Chapter 5

Product Specifications

5.1 Product Specifications (TM-T70)

Table 5-16 Specifications

Print method	Thermal line printing
Print width	Standard: paper width of 80 mm — print width of 72 mm {2.84"}, 512 dot positions
Cut type	Partial cut (left-most one point uncut)
Character sets	95 alphanumeric, 48 international characters, 128 x 11 pages of extended graphics
Interface (compatible)	Serial (RS232/RS485)/ Parallel (IEEE1284)/ Ethernet (10/100BASE-T)/ USB (Full)/ Wireless LAN (802.11b)
Buffer	Receive buffer: 4KB/45 bytes (Selectable with the DIP switches)
	User-defined buffer For both downloaded bitmap images and fonts: Approx. 12KB
	NV graphics data storage area: 256KB NV user memory: 1KB
DKD function	2 drives
Power supply	Power supplied by optional AC adapter: PS-180
Operating voltage	24 VDC ± 7%
Current consumption	High-speed mode Average: Approx. 1.8 A (Font A, α-N, 36 capital letters, rolling pattern, 42-column printing) Low-power mode Average: Approx. 1.2 A (Font A, α-N, 36 capital letters, rolling pattern, 42-column printing) Standby: Average: Approx. 0.1mA (Note: The maximum drawer kick-out drive current is 1 A.)
Temperature/humidity	Operating: 5 to 45°C (41 to 113°F), 10 to 90% RH Storage: Shipped packed state -10 to +50°C (14 to 122°F), 10 to 90% RH
Weight	Approx. 1.8 kg {3.968 lb}

5.2 Print Specifications (TM-T70)

Table 5-17 Print characteristics

Characteristics	Specifications
Print method	Thermal line printing
Paper feed method	Unidirectional with friction feed
Print width	72 mm {2.84"} (80mm paper width model)
Characters per line	See table titled "Print width/characters per line," below.
Print speed	See table titled "Print speed," below.
Paper feed speed	See table titled "Specifications".
Carriage return width	4.23 mm or 1/6"

Table 5-18 Print width/characters per line

Paper width (mm)	Roll paper width (mm)
	80 (standard)
Number of print dots	512
Print width (mm)	72 {2.84"}
Font A (12 × 24) number of columns	42
Font B (9 × 17) number of columns	56

Table 5-19 Print speed

Print control mode	Unit	Setting	Print speed (approx.)
High-speed mode (*1)	mm/sec	—	170mm/s {6.99"/s}
	lps	Line space setting: 4.23 mm {1/6"}	40.2 lps
Low-power mode	mm/sec	—	150mm/s {5.9"/s}
	lps	Line space setting: 4.23 mm {1/6"}	35.5lps
Printing ladder bar codes and 2D code	mm/sec	High-speed mode: Line space setting: 4.23 mm {1/6"}	100mm/s {3.9"/s}
	mm/sec	Low-speed mode: Line space setting: 4.23 mm {1/6"}	60mm/s {2.4"/s}
Bit image and Page mode	mm/sec	Low-speed mode: Line space setting: 4.23 mm {1/6"}	60mm/s {2.4"/s}

lps: lines per second

*1: During printing (at 24 V, 28°C {82.4°F}, Print density Normal). Note, however, the print speed automatically changes with the voltage applied to the printer and with the head temperature conditions.



Note:

The print speed sometimes slows down, depending on the data transfer speed and other settings.

A slow baud rate is a probable cause of intermittent printing. We recommend using a faster baud rate.

5.3 Character Specifications (TM-T70)

Table 5-20 Character specifications

Item	Specifications	
Character type	Alphanumeric	95 character sets
	International	48 types
	Extended graphics	128 characters × 11 pages (including 1 blank page)
Character configuration	See table titled "Character configurations and dimensions," below. (Default is font A.)	
Character dimensions	See "Character configurations and dimensions," below. (Spaces between characters not included.)	

Table 5-21 Character configurations and dimensions

	Standard	Double-height	Double-width	Double-width / Double-height
	W × H (mm)	W × H (mm)	W × H (mm)	W × H (mm)
Font A (12 × 24)	1.41 × 3.39	1.41 × 6.77	2.82 × 3.39	2.82 × 6.77
Font B (9 × 17)	0.99 × 2.40	0.99 × 4.80	1.98 × 2.40	1.98 × 4.80

Notes: 1. Spaces between characters not included.
 2. Characters can be scaled up to 64 times as large as the standard size.

5.4 Paper Specifications (TM-T70)

See Appendix B.

5.5 Printable Area (TM-T70)

For 80mm paper width model:

The printable area of a paper with width of 79.5 ± 0.5 mm { 3.13 ± 0.02 "} is 72.2 ± 0.2 mm { 2.84 ± 0.008 "} (512 dots) and the space on the right and left sides are approximately 3.7 ± 2 mm { 0.15 ± 0.079 "}.

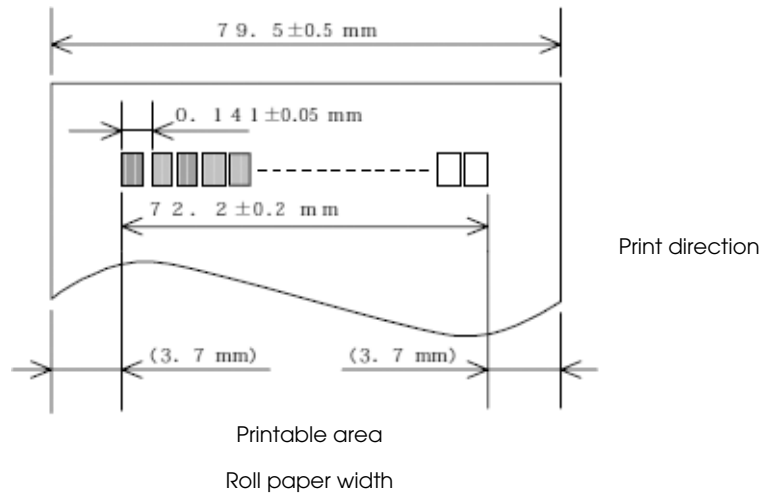

Figure 5-23 Printable area

Table 5-22 Dimensions

a (roll paper width)	b (left margin)	c (print width)	d (right margin)
79.5 ± 0.5	3.7	72.2 ± 0.2	3.7

* Units: mm

5.6 Print Position versus Cutter Position (TM-70)

The following illustration shows the relationship between print position and cutter position.

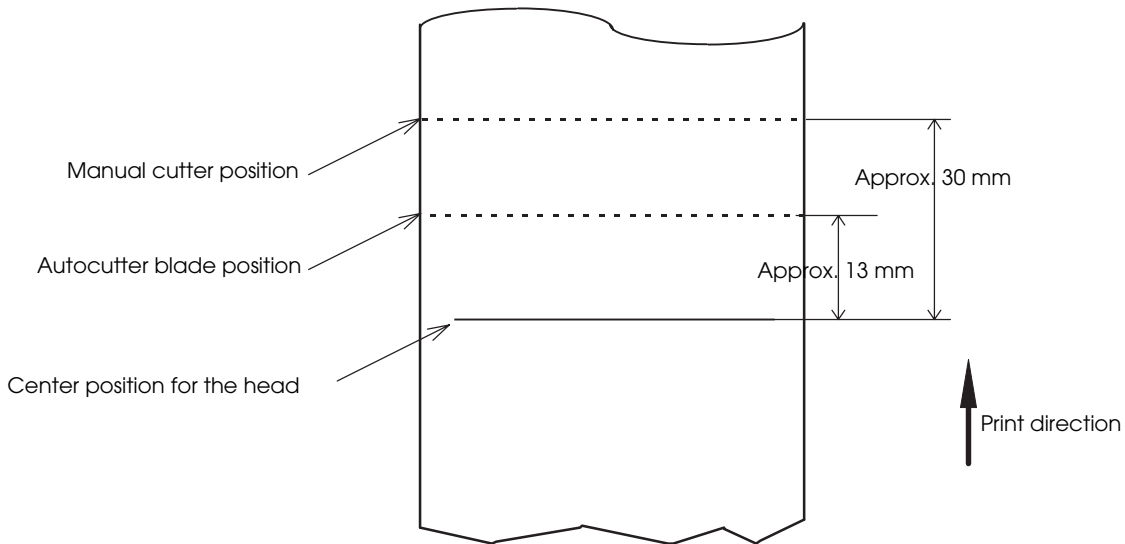

Figure 5-24 Print position versus cutter position



Note:

The values in the figure are center values. The margins vary, due to paper slack or paper variations from piece to piece. Allow a certain margin of error when setting the paper cutter cut position.

5.7 Overview of External Dimensions (TM-T70)

5.7.1 External Dimensions

- ❑ Height Approx. 114mm {4.49"}
- ❑ Width Approx. 125mm {4.92"}
- ❑ Depth Approx. 194mm {7.64"}
- ❑ Weight Approx. 1.8 kg {3.97 lb} (without roll paper)

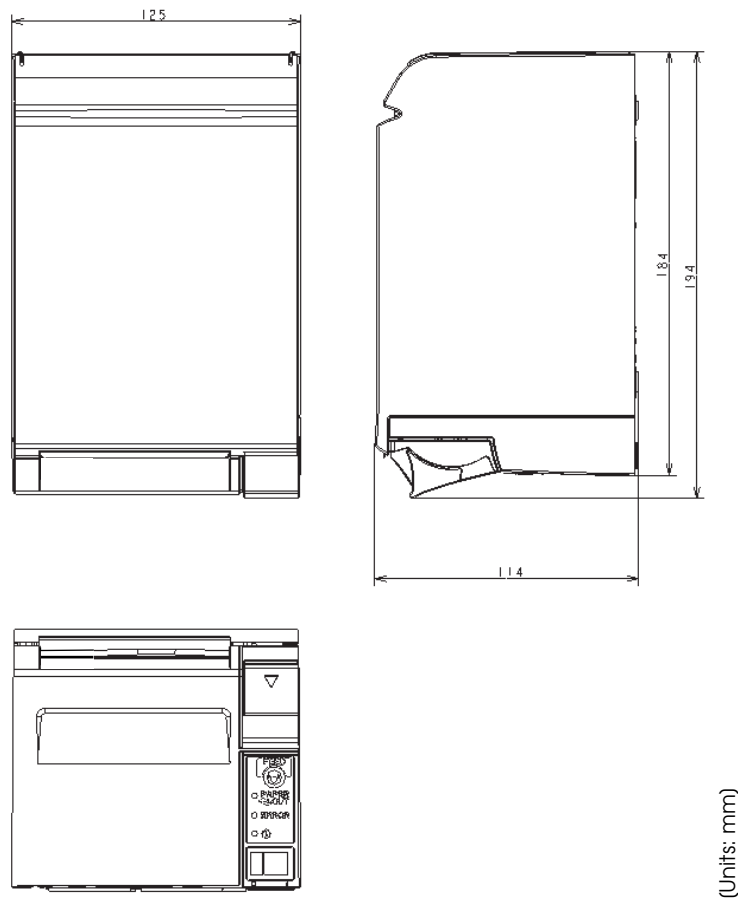

Figure 5-25 Dimensions

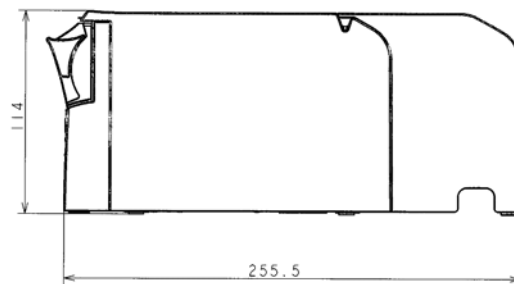

Figure 5-26 When the optional OT-CC70 is installed

5.8 Operating Specifications (TM-T70)

Table 5-23 Temperature and humidity

Item	Specifications	
Temperature/ Humidity	Operating:	5 to 45°C (41 to 113°F), 10 to 90% RH no condensation allowed. (Refer to ambient operating ranges in the figure below.)
	Storage: (shipped packed state)	-10 to +50°C (14 to 122°F), 10 to 90% RH (excluding paper)
Acoustic noise	Operating:	Approximately 55 dB (Bystander position) NOTE: The values above are measured in the Epson evaluation condition. The acoustic noise differs depending on the paper used, printing contents, or the setting values such as print speed or print density.

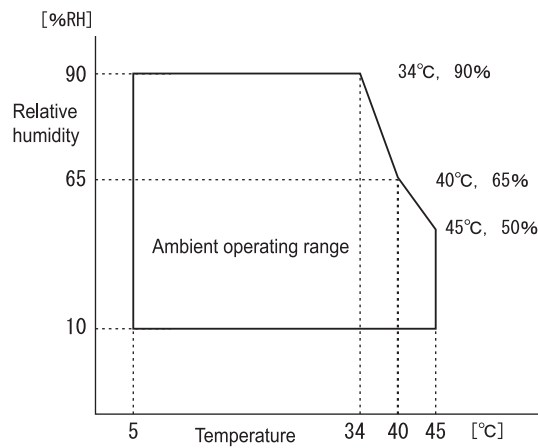

Figure 5-27

Appendix A

Interfaces and Connectors

A.1 RS-232 Serial Interface

A.1.1 Interface Board Specifications (RS-232-compliant)

Table A-1 Serial interface specifications

Item		Specifications
Data transfer method		Serial
Synchronization		Asynchronous
Handshake		Select one of the following with DIP SW1-3: <input type="checkbox"/> DTR/DSR (DIP SW1-3 OFF) default <input type="checkbox"/> XON/XOFF (DIP SW1-3 ON)
Signal level	MARK	-3 V to -15 V logic "1" /ON
	SPACE	+3 V to +15 V logic "0" /OFF
Bit length		Select one of the following with DIP SW1-4: <input type="checkbox"/> 7 bit (DIP SW1-4 ON) <input type="checkbox"/> 8 bit (DIP SW1-4 OFF) default
Baud rate		Select one of the following with DIP SW1-7 and SW1-8: 4800bps, 9600bps, 19200bps, 38400bps Select one of the following with Commands: 2400bps, 4800bps, 9600bps, 19200bps, 38400bps, 57600bps, 115200bps (bps: bits per second)
Parity check		Select one of the following with DIP SW1-5: <input type="checkbox"/> Yes (DIP SW1-5 ON) <input type="checkbox"/> No (DIP SW1-5 OFF)
Parity selection		Select one of the following with DIP SW1-6: <input type="checkbox"/> Even (DIP SW1-6 ON) <input type="checkbox"/> Odd (DIP SW1-6 OFF)
Stop bit		1 or more bits However, the stop bit for data transfer from the printer is fixed to 1 bit.
Connector	Printer side	DSUB 25-pin (female) connector

A.1.2 Functions of each Connector Pin

Table A-2 Pin assignments

Pin no.	Signal name	Signal direction	Function
1	FG	—	Frame ground
2	TXD	Output	Transmission data
3	RXD	Input	Reception data
4	RTS	Output	Equivalent to DTR signal (pin 20)
6	DSR	Input	This signal indicates whether the host computer can receive data. SPACE indicates that the host computer can receive data. MARK indicates that the host computer cannot receive data. When DTR/DSR control is selected, the printer transmits data after confirming this signal (except if transmitted using some ESC/POS commands). When XON/XOFF control is selected, the printer does not check this signal. Changing DIP SW2-7 lets this signal be used as a printer reset signal. When you use this signal as the printer's reset signal, the printer is reset when the signal remains MARK for a pulse width of 1 ms or more.
7	SG	—	Signal ground
20	DTR	Output	1) When DTR/DSR control is selected, this signal indicates whether the printer is Busy. SPACE status — indicates the printer is ready to receive data. MARK status — indicates the printer is Busy. Set Busy conditions with DIP SW2-1. (Refer to "Busy State" on page 3-10). 2) When XON/XOFF control is selected, the signal indicates that the printer is properly connected and ready to receive data from the host. SPACE status — indicates the printer is properly connected and ready to receive data from the host. The signal is always SPACE, except in the following cases: <ul style="list-style-type: none"> • During the period from when power is turned on to when the printer is ready to receive data. • During the self-test.
25	INIT	Input	Changing DIP SW2-8 enables this signal to be used as a reset signal for the printer. The printer is reset if the signal remains at SPACE for a pulse width of 1 ms or more.

A.1.3 XON/XOFF

When XON/XOFF control is selected, the printer transmits the XON or XOFF signals as follows. The transmission timing of XON/XOFF differs, depending on the setting of DIP SW2-1.

Table A-3 XON/XOFF transmissions

Signal	Printer status	DIP SW2-1 status	
		1 (ON)	0 (OFF)
XON	1) When the printer goes online after turning on the power (or reset using the interface)	Transmit	Transmit
	2) When the receive buffer is released from the buffer full state	Transmit	Transmit
	3) When the printer switches from offline to online	—	Transmit
	4) When the printer recovers from an error using some ESC/POS commands	—	Transmit
XOFF	5) When the receive buffer becomes full	Transmit	Transmit
	6) When the printer switches from online to offline	—	Transmit

A.1.4 Code

The hexadecimal numbers corresponding to the XON/XOFF codes are shown below.

- ❑ XON code: 11H
- ❑ XOFF code: 13H



Note:

When the printer goes from offline to online and the receive buffer is full, XON is not transmitted.

When the printer goes from online to offline and the receive buffer is full, XOFF is not transmitted.

When memory switch Dip switch 1-3 is off, XON is not transmitted as long as the printer is offline, even if a receive buffer full state has been cleared.

A.2 IEEE 1284 Parallel Interface

A.2.1 Modes

The IEEE 1284 parallel interface supports the following two modes.

Table A-4 Parallel modes

Mode	Communication direction	Other information
Compatibility mode	Host → Printer communication	Centronics-compliant
Reverse mode	Printer → Host communication	Assumes a data transfer from an asynchronous printer

Compatibility mode

Compatibility mode allows data transmission from host to printer only: Centronics-compatible.

Specifications

- Data transmission: 8-bit parallel
- Synchronization: Externally supplied $\overline{\text{STROBE}}$ * signals
- Handshaking: $\overline{\text{ACK}}$ * and BUSY signals
- Signal levels: TTL-compatible connector
- Connector: ADS-B36BLFDR176 (HONDA) or equivalent product (IEEE 1284 Type B)
- Reverse communication: Nibble or byte mode

*A rule above a signal name indicates an “L” active signal.

Reverse mode

The transfer of status data from the printer to the host proceeds in the nibble or byte mode.

This mode allows data transfer from an asynchronous printer under the control of the host. Data transfers in the nibble mode are made via the existing control lines in units of four bits (a nibble). In the byte mode, data transfer proceeds by making the 8-bit data lines bidirectional. Both modes fail to proceed concurrently in the compatibility mode, thereby causing half-duplex transmission.

A.2.2 Interface Signals

Table A-5 Connector pin assignments

Pin	Source	Compatibility Mode	Nibble Mode	Byte Mode
1	Host	$\overline{\text{Strobe}}$	HostClk	HostClk
2	Host/Ptr	Data0(LSB)	Data0 (LSB)	Data0 (LSB)
3	Host/Ptr	Data1	Data1	Data1
4	Host/Ptr	Data2	Data2	Data2
5	Host/Ptr	Data3	Data3	Data3
6	Host/Ptr	Data4	Data4	Data4
7	Host/Ptr	Data5	Data5	Data5
8	Host/Ptr	Data6	Data6	Data6
9	Host/Ptr	Data7 (MSB)	Data7 (MSB)	Data7 (MSB)
10	Printer	$\overline{\text{Ack}}$	PtrClk	PtrClk
11	Printer	Busy	PtrBusy/Data3, 7	PtrBusy
12	Printer	Perror	AckDataReq/Data2, 6	AckDataReq
13	Printer	Select	Xflag/Data1, 5	Xflag
14	Host	$\overline{\text{AutoFd}}$	HostBusy k	HostBusy
15		NC	ND	ND
16		GND	GND	GND
17		FG	FG	FG
18	Printer	Logic-H	Logic-H	Logic-H
19		GND	GND	GND
20		GND	GND	GND
21		GND	GND	GND
22		GND	GND	GND
23		GND	GND	GND
24		GND	GND	GND
25		GND	GND	GND
26		GND	GND	GND
27		GND	GND	GND
28		GND	GND	GND
29		GND	GND	GND
30		GND	GND	GND
31	Host	$\overline{\text{Inif}}$	$\overline{\text{Inif}}$	$\overline{\text{Inif}}$
32	Printer	$\overline{\text{Fault}}$	$\overline{\text{DataAvail/Data0, 4}}$	$\overline{\text{DataAvail}}$
33		GND	ND	ND
34	Printer	DK_STATUS	ND	ND
35	Printer	+5V	ND	ND
36	Host	$\overline{\text{SelectIn}}$	1284-Active	1284-Active

* NC: Not Connected

ND: Not Defined



Note:

A signal name with a rule above it indicates an “L” active signal.

Bidirectional communications cannot take place, unless all signal names for both sides correspond to each other.

Connect all signal lines using a twisted-pair cable. Connect the return side to the signal ground level.

Make sure the signals satisfy electrical characteristics.

Set the leading edge and trailing edge times to 0.5 μ s or less.

Do not ignore $\overline{\text{Ack}}$ or BUSY signals during a data transfer. Ignoring such signals may result in data corruption.

Make the interface cables as short as possible.

Appendix B

Options and Consumables

B.1 Roll Paper

The table below shows the roll paper specifications.

Table B-1 Paper specifications

Type of paper	Specified thermal paper	
Shape	Roll	
Paper width	Select from the following: <input type="checkbox"/> 79.5 mm ± 0.5 mm (default)	
Roll core	Internal diameter	12 mm {0.47"}
	Outer diameter	18 mm {0.71"}
External dimensions	Outer diameter	83 mm {3.27"} or less
Thermal paper type	Specified: Nakagawa Seisakujo, NTP080-80 (Original: Nippon Paper Industries Co., Ltd., TF50KS-E)	



Note:

If roll core standards vary from the figures above, it is difficult for the roll paper NE detector to detect the remaining amount of roll paper exactly. Use these figures merely as a guideline.

B.2 Power Supply

The following describes the specifications for the optional power supplies (PS-180).

B.2.1 PS-180

B.2.1.1 Electrical characteristics

- Input conditions
 - Input voltage (rating): 90 to 264 VAC
(100 VAC -10% to 230 VAC +15%)
 - Frequency (rating): 50/60 Hz ± 3 Hz
 - Power consumption (rating): 100 VA
- Output conditions
 - Output voltage (rating): 24 VDC ± 5%
 - Output current (rating): 2.0 A
 - Output electric power (rating): 48 VA
 - Output peak current: 4.5 A

B.2.1.2 Case specifications

- ❑ Dimensions: 68 mm (D) × 136 mm (L) × 33 mm (H) (excluding projections) {2.68" × 5.35" × 1.26"} Refer to the figure below.
- ❑ Weight: Approx. 0.4 kg {14.11 oz} (excluding the AC cable)
- ❑ Material: Durability level: V0
- ❑ Color: Black (matte)

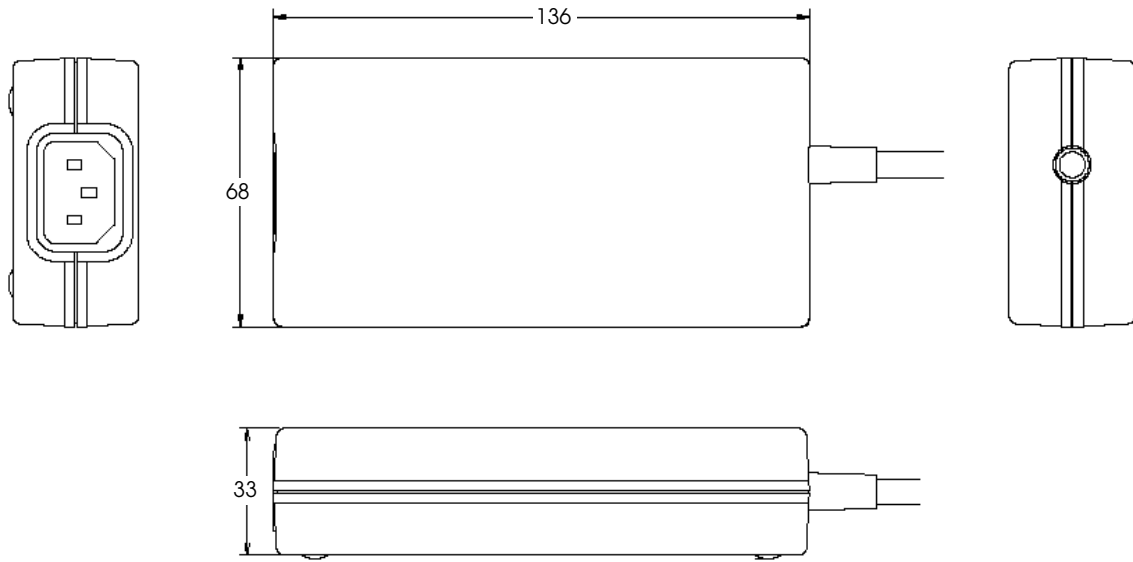

Figure B-1 Case specifications

B.2.1.3 Material

No specific brominated flame retardants, such as PBBE and PBB, are used in this product.

B.2.1.4 AC cable selection

- ❑ Select an AC cable that satisfies the following conditions.
 - Safety standard product
 - Plug with PE terminal
- ❑ Ground connection: Be sure to ground for safety.

C.2 Page 1 (Katakana)

	HEX	8	9	A	B	C	D	E	F
HEX	BIN	1000	1001	1010	1011	1100	1101	1110	1111
0	0000	┌ 128	┌ 144	SP 160	一 176	夕 192	ミ 208	二 224	× 240
1	0001	┌ 129	┌ 145	。○ 161	ア 177	チ 193	ム 209	ト 225	円 241
2	0010	┌ 130	┌ 146	「 162	イ 178	ツ 194	メ 210	≠ 226	年 242
3	0011	┌ 131	┌ 147	」 163	ウ 179	テ 195	モ 211	≠ 227	月 243
4	0100	┌ 132	┌ 148	、 164	エ 180	ト 196	ヤ 212	▲ 228	日 244
5	0101	┌ 133	┌ 149	・ 165	オ 181	ナ 197	ユ 213	▲ 229	時 245
6	0110	┌ 134	┌ 150	ヲ 166	カ 182	ニ 198	ヨ 214	▼ 230	分 246
7	0111	┌ 135	┌ 151	ア 167	キ 183	ヌ 199	ラ 215	▼ 231	秒 247
8	1000	┌ 136	┌ 152	「 168	ク 184	ネ 200	リ 216	♠ 232	〒 248
9	1001	┌ 137	┌ 153	「 169	ケ 185	ノ 201	ル 217	♥ 233	市 249
A	1010	┌ 138	┌ 154	「 170	コ 186	ハ 202	レ 218	◆ 234	区 250
B	1011	┌ 139	┌ 155	」 171	サ 187	ヒ 203	ロ 219	♣ 235	町 251
C	1100	┌ 140	┌ 156	「 172	シ 188	フ 204	ワ 220	● 236	村 252
D	1101	┌ 141	┌ 157	「 173	ス 189	ヘ 205	ン 221	○ 237	人 253
E	1110	┌ 142	┌ 158	「 174	セ 190	ホ 206	・ 222	／ 238	☼ 254
F	1111	┌ 143	┌ 159	「 175	ソ 191	マ 207	・ 223	＼ 239	SP 255

C.3 Page 2 (PC850: Multilingual)

	HEX	8	9	A	B	C	D	E	F
HEX	BIN	1000	1001	1010	1011	1100	1101	1110	1111
0	0000	Ç 128	É 144	á 160	⌘ 176	⌚ 192	ð 208	Ó 224	— 240
1	0001	ü 129	æ 145	í 161	⌘ 177	⌚ 193	Ð 209	ß 225	± 241
2	0010	é 130	Æ 146	ó 162	⌘ 178	⌚ 194	Ê 210	Ô 226	= 242
3	0011	â 131	ô 147	ú 163	 179	⌚ 195	Ë 211	Ò 227	³ / ₄ 243
4	0100	ä 132	ö 148	ñ 164	⌘ 180	— 196	È 212	õ 228	¶ 244
5	0101	à 133	ò 149	Ñ 165	Á 181	⌚ 197	ı 213	Õ 229	§ 245
6	0110	å 134	û 150	ä 166	Â 182	ã 198	Í 214	µ 230	÷ 246
7	0111	ç 135	ù 151	o 167	À 183	Ã 199	Î 215	þ 231	· 247
8	1000	ê 136	ÿ 152	ı 168	© 184	⌚ 200	Ï 216	þ 232	° 248
9	1001	ë 137	Ö 153	® 169	⌘ 185	⌚ 201	⌚ 217	Ú 233	¨ 249
A	1010	è 138	Ü 154	⌘ 170	⌘ 186	⌚ 202	⌚ 218	Û 234	· 250
B	1011	ï 139	ø 155	¹ / ₂ 171	⌘ 187	⌚ 203	■ 219	Ü 235	¹ / ₂ 251
C	1100	î 140	£ 156	¹ / ₄ 172	⌘ 188	⌚ 204	■ 220	Ý 236	³ / ₄ 252
D	1101	ì 141	Ø 157	ı 173	¢ 189	— 205	ı 221	Ý 237	² / ₃ 253
E	1110	Ä 142	× 158	« 174	¥ 190	⌚ 206	Ï 222	— 238	■ 254
F	1111	Å 143	f 159	» 175	⌘ 191	⌚ 207	■ 223	’ 239	SP 255

C.4 Page 3 (PC860: Portuguese)

	HEX	8	9	A	B	C	D	E	F
HEX	BIN	1000	1001	1010	1011	1100	1101	1110	1111
0	0000	Ç 128	É 144	á 160	☼ 176	┌ 192	└ 208	α 224	≡ 240
1	0001	ü 129	À 145	í 161	☼ 177	└ 193	┘ 209	β 225	≠ 241
2	0010	é 130	È 146	ó 162	☼ 178	┘ 194	┘ 210	Γ 226	≥ 242
3	0011	â 131	ô 147	ú 163	 179	┘ 195	┌ 211	π 227	≤ 243
4	0100	ã 132	õ 148	ñ 164	┘ 180	— 196	┌ 212	Σ 228	∫ 244
5	0101	à 133	ò 149	Ñ 165	≡ 181	⊕ 197	┘ 213	σ 229	∫ 245
6	0110	Á 134	Ú 150	a 166	┘ 182	┘ 198	┘ 214	μ 230	÷ 246
7	0111	ç 135	ù 151	o 167	┘ 183	┘ 199	⊕ 215	τ 231	≈ 247
8	1000	ê 136	î 152	¿ 168	┘ 184	┌ 200	⊕ 216	Φ 232	° 248
9	1001	Ê 137	Ï 153	Ò 169	≡ 185	┘ 201	┘ 217	θ 233	• 249
A	1010	è 138	Û 154	¬ 170	 186	└ 202	┘ 218	Ω 234	· 250
B	1011	Í 139	ç 155	½ 171	┘ 187	┘ 203	■ 219	δ 235	√ 251
C	1100	Ô 140	£ 156	¼ 172	┘ 188	┘ 204	■ 220	∞ 236	n 252
D	1101	ì 141	Ù 157	¡ 173	┘ 189	== 205	■ 221	∅ 237	² 253
E	1110	Ã 142	Þ 158	« 174	┘ 190	⊕ 206	■ 222	∈ 238	■ 254
F	1111	Â 143	Ó 159	» 175	┘ 191	└ 207	■ 223	∩ 239	SP 255

C.5 Page 4 (PC863: Canadian-French)

	HEX	8	9	A	B	C	D	E	F
HEX	BIN	1000	1001	1010	1011	1100	1101	1110	1111
0	0000	Ç 128	É 144	Ï 160	Ë 176	Ï 192	Ï 208	α 224	≡ 240
1	0001	ü 129	È 145	´ 161	Ë 177	Ï 193	Ï 209	β 225	± 241
2	0010	é 130	Ê 146	ó 162	Ë 178	Ï 194	Ï 210	Γ 226	≥ 242
3	0011	â 131	ô 147	ú 163	 179	Ï 195	Ï 211	π 227	≤ 243
4	0100	Â 132	Ë 148	¨ 164	Ï 180	Ï 196	Ï 212	Σ 228	∫ 244
5	0101	à 133	ï 149	· 165	Ï 181	Ï 197	Ï 213	σ 229	∫ 245
6	0110	¶ 134	û 150	³ 166	Ï 182	Ï 198	Ï 214	μ 230	÷ 246
7	0111	ç 135	ù 151	— 167	Ï 183	Ï 199	Ï 215	τ 231	≈ 247
8	1000	ê 136	æ 152	î 168	Ï 184	Ï 200	Ï 216	Φ 232	° 248
9	1001	ë 137	ô 153	Ï 169	Ï 185	Ï 201	Ï 217	θ 233	· 249
A	1010	è 138	Û 154	Ï 170	Ï 186	Ï 202	Ï 218	Ω 234	· 250
B	1011	ï 139	ç 155	½ 171	Ï 187	Ï 203	■ 219	δ 235	√ 251
C	1100	î 140	£ 156	¼ 172	Ï 188	Ï 204	■ 220	∞ 236	n 252
D	1101	= 141	Û 157	¾ 173	Ï 189	= 205	■ 221	∅ 237	² 253
E	1110	À 142	Û 158	« 174	Ï 190	Ï 206	■ 222	∈ 238	■ 254
F	1111	§ 143	f 159	» 175	Ï 191	Ï 207	■ 223	∩ 239	SP 255

















































C.6 Page 5 (PC865: Nordic)

	HEX	8	9	A	B	C	D	E	F
HEX	BIN	1000	1001	1010	1011	1100	1101	1110	1111
0	0000	Ç 128	É 144	á 160	☒ 176	┘ 192	┘ 208	α 224	≡ 240
1	0001	ü 129	æ 145	í 161	☒ 177	┘ 193	┘ 209	β 225	± 241
2	0010	é 130	Æ 146	ó 162	☒ 178	┘ 194	┘ 210	Γ 226	≥ 242
3	0011	â 131	ô 147	ú 163	 179	┘ 195	┘ 211	π 227	≤ 243
4	0100	ä 132	ö 148	ñ 164	┘ 180	— 196	┘ 212	Σ 228	ƒ 244
5	0101	à 133	ò 149	Ñ 165	┘ 181	┘ 197	┘ 213	σ 229	Ј 245
6	0110	å 134	û 150	а 166	┘ 182	┘ 198	┘ 214	μ 230	÷ 246
7	0111	ç 135	ù 151	о 167	┘ 183	┘ 199	┘ 215	τ 231	≈ 247
8	1000	ê 136	ÿ 152	ı 168	┘ 184	┘ 200	┘ 216	Φ 232	° 248
9	1001	ë 137	Ö 153	┘ 169	┘ 185	┘ 201	┘ 217	θ 233	• 249
A	1010	è 138	Ü 154	┘ 170	 186	┘ 202	┘ 218	Ω 234	· 250
B	1011	ï 139	ø 155	½ 171	┘ 187	┘ 203	■ 219	δ 235	√ 251
C	1100	î 140	£ 156	¼ 172	┘ 188	┘ 204	■ 220	∞ 236	n 252
D	1101	ì 141	Ø 157	ı 173	┘ 189	== 205	■ 221	ø 237	² 253
E	1110	Ä 142	Pt 158	« 174	┘ 190	┘ 206	■ 222	€ 238	■ 254
F	1111	Å 143	f 159	α 175	┘ 191	┘ 207	■ 223	∩ 239	SP 255

C.7 Page 16 (WPC1252)

	HEX	8	9	A	B	C	D	E	F
HEX	BIN	1000	1001	1010	1011	1100	1101	1110	1111
0	0000	€ 128	SP 144	SP 160	° 176	À 192	Ð 208	à 224	ð 240
1	0001	SP 129	‘ 145	í 161	± 177	Á 193	Ñ 209	á 225	ñ 241
2	0010	, 130	, 146	¢ 162	² 178	Â 194	Ò 210	â 226	ò 242
3	0011	f 131	“ 147	£ 163	³ 179	Ã 195	Ó 211	ã 227	ó 243
4	0100	” 132	” 148	¤ 164	´ 180	Ä 196	Ô 212	ä 228	ô 244
5	0101	… 133	· 149	¥ 165	µ 181	Å 197	Õ 213	å 229	õ 245
6	0110	† 134	— 150	 166	¶ 182	Æ 198	Ö 214	æ 230	ö 246
7	0111	‡ 135	— 151	§ 167	· 183	Ç 199	× 215	ç 231	+ 247
8	1000	^ 136	~ 152	¨ 168	¸ 184	È 200	Ø 216	è 232	ø 248
9	1001	‰ 137	™ 153	© 169	¹ 185	É 201	Ù 217	é 233	ù 249
A	1010	Š 138	š 154	ª 170	º 186	Ê 202	Ú 218	ê 234	ú 250
B	1011	‹ 139	› 155	« 171	» 187	Ë 203	Û 219	ë 235	û 251
C	1100	Œ 140	œ 156	¬ 172	¼ ^{1/4} 188	Ì 204	Ü 220	ì 236	ü 252
D	1101	SP 141	SP 157	- 173	½ ^{1/2} 189	Í 205	Ý 221	í 237	ý 253
E	1110	Ž 142	ž 158	® 174	¾ ^{3/4} 190	Î 206	Þ 222	î 238	þ 254
F	1111	SP 143	ÿ 159	— 175	¿ 191	Ï 207	ß 223	ï 239	ÿ 255

C.8 Page 17 (PC866: Cyrillic #2)

	HEX	8	9	A	B	C	D	E	F
HEX	BIN	1000	1001	1010	1011	1100	1101	1110	1111
0	0000	А 128	Р 144	а 160	 176	 192	 208	р 224	Ё 240
1	0001	Б 129	С 145	б 161	 177	 193	 209	с 225	ё 241
2	0010	В 130	Т 146	в 162	 178	 194	 210	т 226	ѐ 242
3	0011	Г 131	У 147	г 163	 179	 195	 211	у 227	ѓ 243
4	0100	Д 132	Ф 148	д 164	 180	 196	 212	ф 228	ї 244
5	0101	Е 133	Х 149	е 165	 181	 197	 213	х 229	і 245
6	0110	Ж 134	Ц 150	ж 166	 182	 198	 214	ц 230	ў 246
7	0111	З 135	Ч 151	з 167	 183	 199	 215	ч 231	џ 247
8	1000	И 136	Ш 152	и 168	 184	 200	 216	ш 232	° 248
9	1001	Й 137	Щ 153	й 169	 185	 201	 217	щ 233	• 249
A	1010	К 138	Ъ 154	к 170	 186	 202	 218	ъ 234	· 250
B	1011	Л 139	Ы 155	л 171	 187	 203	 219	ы 235	√ 251
C	1100	М 140	Ь 156	м 172	 188	 204	 220	ь 236	№ 252
D	1101	Н 141	Э 157	н 173	 189	 205	 221	э 237	⊠ 253
E	1110	О 142	Ю 158	о 174	 190	 206	 222	ю 238	 254
F	1111	П 143	Я 159	п 175	 191	 207	 223	я 239	SP 255

C.9 Page 18 (PC852: Latin2)

	HEX	8	9	A	B	C	D	E	F
HEX	BIN	1000	1001	1010	1011	1100	1101	1110	1111
0	0000	Ç 128	É 144	á 160	☐ 176	☐ 192	d 208	Ó 224	- 240
1	0001	ü 129	Í 145	í 161	■ 177	☐ 193	Đ 209	ß 225	” 241
2	0010	é 130	Í 146	ó 162	■ 178	☐ 194	Ď 210	Ô 226	‘ 242
3	0011	â 131	ô 147	ú 163	☐ 179	☐ 195	Ě 211	Ň 227	ˇ 243
4	0100	ä 132	ö 148	À 164	☐ 180	☐ 196	ď 212	ń 228	ˇ 244
5	0101	û 133	Ľ 149	ą 165	Á 181	☐ 197	Ň 213	ň 229	§ 245
6	0110	ć 134	ĭ 150	Ž 166	Â 182	Ă 198	í 214	Š 230	÷ 246
7	0111	ç 135	Ś 151	ž 167	Ě 183	ǎ 199	î 215	š 231	· 247
8	1000	ì 136	ś 152	Ę 168	Ş 184	☐ 200	ě 216	Ŕ 232	° 248
9	1001	ë 137	Ö 153	e 169	☐ 185	☐ 201	☐ 217	Ú 233	” 249
A	1010	Ö 138	Ü 154	☐ 170	☐ 186	☐ 202	☐ 218	ř 234	· 250
B	1011	ö 139	Ť 155	ź 171	☐ 187	☐ 203	■ 219	Ů 235	ů 251
C	1100	î 140	ť 156	Č 172	☐ 188	☐ 204	■ 220	ý 236	Ř 252
D	1101	Ž 141	Ł 157	ś 173	Ż 189	☐ 205	Ť 221	Ý 237	ř 253
E	1110	Ä 142	× 158	« 174	ż 190	☐ 206	Ů 222	ı 238	■ 254
F	1111	Ć 143	č 159	» 175	☐ 191	☐ 207	■ 223	’ 239	SP 255

C.10 Page 19 (PC858: Euro)

	HEX	8	9	A	B	C	D	E	F
HEX	BIN	1000	1001	1010	1011	1100	1101	1110	1111
0	0000	Ç 128	É 144	á 160	⌘ 176	⌚ 192	Đ 208	Ó 224	— 240
1	0001	ü 129	æ 145	í 161	⌘ 177	⌚ 193	Đ 209	ß 225	± 241
2	0010	é 130	Æ 146	ó 162	⌘ 178	⌚ 194	Ê 210	Ô 226	= 242
3	0011	â 131	ô 147	ú 163	 179	⌚ 195	Ë 211	Ò 227	$\frac{3}{4}$ 243
4	0100	ä 132	ö 148	ñ 164	⌚ 180	— 196	È 212	õ 228	¶ 244
5	0101	à 133	ò 149	Ñ 165	Á 181	⌚ 197	€ 213	Ö 229	§ 245
6	0110	å 134	û 150	ä 166	Â 182	ã 198	í 214	μ 230	÷ 246
7	0111	ç 135	ù 151	ó 167	À 183	Ã 199	î 215	þ 231	· 247
8	1000	ê 136	ÿ 152	¿ 168	© 184	⌚ 200	Ï 216	þ 232	° 248
9	1001	ë 137	Ö 153	® 169	⌚ 185	⌚ 201	⌚ 217	Ú 233	¨ 249
A	1010	è 138	Ü 154	⌚ 170	⌚ 186	⌚ 202	⌚ 218	Û 234	· 250
B	1011	ï 139	ø 155	$\frac{1}{2}$ 171	⌚ 187	⌚ 203	■ 219	Ü 235	¹ 251
C	1100	î 140	£ 156	$\frac{1}{4}$ 172	⌚ 188	⌚ 204	■ 220	Ý 236	³ 252
D	1101	ì 141	Ø 157	ì 173	¢ 189	= 205	ì 221	Ý 237	² 253
E	1110	Ä 142	× 158	« 174	¥ 190	⌚ 206	ì 222	— 238	■ 254
F	1111	Å 143	f 159	» 175	⌚ 191	⌚ 207	■ 223	' 239	SP 255

C.11 Page 255 (Blank Page)

HEX	BIN	8	9	A	B	C	D	E	F
HEX	BIN	1000	1001	1010	1011	1100	1101	1110	1111
0	0000	SP 128	SP 144	SP 160	SP 176	SP 192	SP 208	SP 224	SP 240
1	0001	SP 129	SP 145	SP 161	SP 177	SP 193	SP 209	SP 225	SP 241
2	0010	SP 130	SP 146	SP 162	SP 178	SP 194	SP 210	SP 226	SP 242
3	0011	SP 131	SP 147	SP 163	SP 179	SP 195	SP 211	SP 227	SP 243
4	0100	SP 132	SP 148	SP 164	SP 180	SP 196	SP 212	SP 228	SP 244
5	0101	SP 133	SP 149	SP 165	SP 181	SP 197	SP 213	SP 229	SP 245
6	0110	SP 134	SP 150	SP 166	SP 182	SP 198	SP 214	SP 230	SP 246
7	0111	SP 135	SP 151	SP 167	SP 183	SP 199	SP 215	SP 231	SP 247
8	1000	SP 136	SP 152	SP 168	SP 184	SP 200	SP 216	SP 232	SP 248
9	1001	SP 137	SP 153	SP 169	SP 185	SP 201	SP 217	SP 233	SP 249
A	1010	SP 138	SP 154	SP 170	SP 186	SP 202	SP 218	SP 234	SP 250
B	1011	SP 139	SP 155	SP 171	SP 187	SP 203	SP 219	SP 235	SP 251
C	1100	SP 140	SP 156	SP 172	SP 188	SP 204	SP 220	SP 236	SP 252
D	1101	SP 141	SP 157	SP 173	SP 189	SP 205	SP 221	SP 237	SP 253
E	1110	SP 142	SP 158	SP 174	SP 190	SP 206	SP 222	SP 238	SP 254
F	1111	SP 143	SP 159	SP 175	SP 191	SP 207	SP 223	SP 239	SP 255

UD: undefined

C.12 International Character Set

Country	ASCII code (Hex)											
	23	24	40	5B	5C	5D	5E	60	7B	7C	7D	7E
USA	#	\$	@	[\]	^	`	{		}	~
France	#	\$	à	°	ç	§	^	`	é	ù	è	~
Germany	#	\$	§	Ä	Ö	Ü	^	`	ä	ö	ü	ß
U.K.	£	\$	@	[\]	^	`	{		}	~
Denmark I	#	\$	@	Æ	Ø	Å	^	`	æ	ø	å	~
Sweden	#	¤	É	Ä	Ö	Å	Ü	é	ä	ö	å	ü
Italy	#	\$	@	°	\	é	^	ù	à	ò	è	ì
Spain I	Pt	\$	@	í	Ñ	¿	^	`	ñ	}	}	~
Japan	#	\$	@	[¥]	^	`	{		}	~
Norway	#	¤	É	Æ	Ø	Å	Ü	é	æ	ø	å	ü
Denmark II	#	\$	É	Æ	Ø	Å	Ü	é	æ	ø	å	ü
Spain II	#	\$	á	í	Ñ	¿	é	`	í	ñ	ó	ú
Latin America	#	\$	á	í	Ñ	¿	é	ü	í	ñ	ó	ú
Korea	#	\$	@	[₩]	^	`	{		}	~
Slovenia/ Croatia	#	\$	Ž	Š	Đ	Ć	Č	ž	š	đ	ć	č
China	#	¥	@	[\]	^	`	{		}	~

EPSON

SEIKO EPSON CORPORATION

Printed in Japan