



P460/P360 Memory Scanners



Product Reference Guide



***P460/P360 Memory Scanners
Product Reference Guide***

*70-37690-04
Revision A
December 2003*



© **2001-2003** by Symbol Technologies, Inc. All rights reserved.

No part of this publication may be reproduced or used in any form, or by any electrical or mechanical means, without permission in writing from Symbol. This includes electronic or mechanical means, such as photocopying, recording, or information storage and retrieval systems. The material in this manual is subject to change without notice.

The software is provided strictly on an “as is” basis. All software, including firmware, furnished to the user is on a licensed basis. Symbol grants to the user a non-transferable and non-exclusive license to use each software or firmware program delivered hereunder (licensed program). Except as noted below, such license may not be assigned, sublicensed, or otherwise transferred by the user without prior written consent of Symbol. No right to copy a licensed program in whole or in part is granted, except as permitted under copyright law. The user shall not modify, merge, or incorporate any form or portion of a licensed program with other program material, create a derivative work from a licensed program, or use a licensed program in a network without written permission from Symbol. The user agrees to maintain Symbol’s copyright notice on the licensed programs delivered hereunder, and to include the same on any authorized copies it makes, in whole or in part. The user agrees not to decompile, disassemble, decode, or reverse engineer any licensed program delivered to the user or any portion thereof.

Symbol reserves the right to make changes to any software or product to improve reliability, function, or design.

Symbol does not assume any product liability arising out of, or in connection with, the application or use of any product, circuit, or application described herein.

No license is granted, either expressly or by implication, estoppel, or otherwise under any Symbol Technologies, Inc., intellectual property rights. An implied license only exists for equipment, circuits, and subsystems contained in Symbol products.

Symbol, Spectrum One, and Spectrum24 are registered trademarks of Symbol Technologies, Inc. Other product names mentioned in this manual may be trademarks or registered trademarks of their respective companies and are hereby acknowledged.

Symbol Technologies, Inc.
One Symbol Plaza
Holtsville, New York 11742-1300
<http://www.symbol.com>

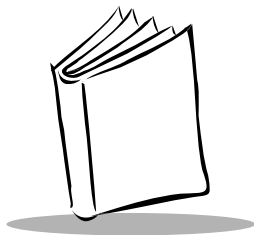

Contents

About This Manual

Introduction	ix
Chapter Descriptions	ix
Notational Conventions	x
Related Publications	x
Service Information	x
Symbol Support Center	xi

Chapter 1. The Phaser Series Scanner

Introduction	1-1
Rechargeable Battery	1-1
The Cradle	1-2
Quick Startup Instructions	1-3
Commonly Used P460/P360 Programming Bar Code	1-4

Chapter 2. Set Up

Introduction	2-1
Unpacking	2-1
Cables	2-2
Connecting the Cable to the Scanner	2-2
Disconnecting Cables from the Scanner	2-3
Setting Up the Cradle	2-4
Scanner Power Options	2-4
Charging the Battery	2-5
Charging Using the Cradle	2-5
Charging Using a Cable	2-6
Charging Using the UBC 2000	2-6
Charge Status LED Indications	2-6
Changing the Battery	2-7

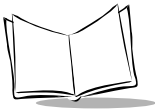

Removing the Battery	2-7
Inserting the Battery	2-8
Connecting to a Host	2-8
When Using the Scanner as a Batch Device	2-8
When Using the Scanner as a Corded Device	2-8
RS-232 Communication with a Host	2-8
Using A Synapse Cable with the cradle	2-9
Using A Synapse Cable with the Scanner	2-10
Wand Emulation, OCIA, OCR, Keyboard Wedges	2-11

Chapter 3. Operation

Introduction	3-1
Default Applications	3-1
Initial Powerup	3-2
Batch / Inventory Application	3-2
Numeric Data Entry	3-3
Alpha Data Entry	3-3
Eliminating Repetitive Scanning	3-4
Reviewing and Deleting Stored Records	3-5
Transmitting Batch/Stored Data to the Host	3-6
Daisy-Chaining Cradles	3-6
Scan and Transmit Application	3-7
System Menu	3-8
System Setup	3-9
App. Control	3-11
Parameter Control	3-14
System Status	3-14
Erase File	3-15
Version	3-16
Return to App	3-16
123Scan	3-17
Suffix Values	3-18
Scanning	3-22
Scan the Entire Symbol	3-22
Hold at an Angle	3-23
Test Symbols	3-24
P460/P360 1D Scanner Decode Zone	3-25
Keypad Operation	3-26

Chapter 4. Maintenance And Specifications

Introduction	4-1
Maintenance	4-1

Troubleshooting	4-2
Optional Accessories	4-5
Technical Specifications	4-6
Pin-outs	4-7
Cradle	4-7
Scanner	4-8
Beeper Indications	4-9

Chapter 5. Parameter Menus

Introduction	5-1
Operational Parameters	5-1
Set Default Parameter	5-7
Communication Protocol	5-8
Scan & Transmit Application	5-8
Batch/Inventory Application	5-9
Host Type	5-10
RS-232 Host Types	5-10
Code ID Characters for RS-232 Host Types	5-12
Sleep Time	5-13
Date Separator	5-14
Hour Type	5-15
Decimal Separator	5-16
Date Format	5-17
Key Click	5-18
Laser On Time	5-19
Host Override	5-20
Beeper Options	5-21
Beeper Tone	5-21
Beeper Volume	5-22
Power Detect Beep	5-23
Beep After Good Decode	5-24
Decode Options	5-25
Transmit "No Read" Message	5-25
Enable/Disable UPC-E	5-26
Enable/Disable UPC-A	5-27
Enable/Disable UPC-E1	5-28
Enable/Disable EAN-8	5-29
Enable/Disable EAN-13	5-30
Enable/Disable Bookland EAN	5-31
Decode UPC/EAN Supplementals	5-32
Decode UPC/EAN Supplemental Redundancy	5-33
Transmit UPC-A/UPC-E/UPC-E1 Check Digit	5-34
UPC-A Preamble	5-35

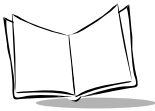

UPC-E Preamble	5-36
UPC-E1 Preamble	5-37
Convert UPC-E to UPC-A	5-38
Convert UPC-E1 to UPC-A	5-39
EAN Zero Extend	5-40
UPC/EAN Coupon Code	5-41
Enable/Disable Code 128	5-42
Enable/Disable UCC/EAN-128	5-43
Lengths for Code 128	5-44
Enable/Disable ISBT 128	5-45
Enable/Disable Code 39	5-46
Enable/Disable Trioptic Code 39	5-47
Set Lengths for Code 39	5-48
Code 39 Check Digit Verification	5-50
Transmit Code 39 Check Digit	5-51
Enable/Disable Code 39 Full ASCII	5-52
Convert Code 39 to Code 32	5-53
Code 32 Prefix	5-54
Enable/Disable Code 93	5-55
Set Lengths for Code 93	5-56
Enable/Disable Interleaved 2 of 5	5-58
Set Lengths for Interleaved 2 of 5	5-59
1 2 of 5 Check Digit Verification	5-61
Transmit 1 2 of 5 Check Digit	5-62
Convert 1 2 of 5 to EAN-13	5-63
Enable/Disable Discrete 2 of 5	5-64
Set Lengths for Discrete 2 of 5	5-65
Enable/Disable Codabar	5-67
Set Lengths for Codabar	5-68
CLSI Editing	5-70
NOTIS Editing	5-71
Enable/Disable MSI Plessey	5-72
Set Lengths for MSI Plessey	5-73
MSI Plessey Check Digits	5-75
Transmit MSI Plessey Check Digit	5-76
MSI Plessey Check Digit Algorithm	5-77
Security Options	5-78
Linear Code Type Security Levels	5-78
Linear Security Level 1	5-78
Linear Security Level 2	5-78
Linear Security Level 3	5-79
Linear Security Level 4	5-79
Bi-directional Redundancy	5-80
UPC/EAN Security Level	5-81

UPC/EAN Security Level 0	5-81
UPC/EAN Security Level 1	5-81
UPC/EAN Security Level 2	5-81
UPC/EAN Security Level 3	5-82
RS-232 Parameters	5-83
Baud Rate	5-83
Parity	5-85
Check Receive Errors	5-86
Hardware Handshaking	5-87
Software Handshaking	5-89
None	5-89
ACK/NAK	5-90
ENQ	5-90
ACK/NAK with ENQ	5-91
XON/XOFF	5-91
Host Serial Response Time-out	5-92
RTS Line State	5-92
Stop Bit Select	5-93
ASCII Format	5-93
Beep on <BEL>	5-94
Intercharacter Delay	5-94
MCL-Net Parameters	5-95
MCL-Net Baud Rate	5-95
MCL-Net Hex Addressing Mode	5-97
Scanner Address	5-98
MCL-Net Transmit Retries	5-98
MCL-Net Frame Timeout	5-98
Numeric Bar Codes	5-99
Cancel	5-101

Appendix A. Bar Code Information

UCC/EAN-128	A-1
AIM Code Identifiers	A-3
Symbol Code Identifier Characters	A-6

Appendix B. Automatic Project Download

Appendix C. Messages and Error Codes

Introduction	B-1
Messages	B-1

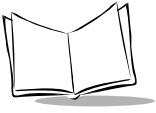

[Index](#)

[Feedback](#)

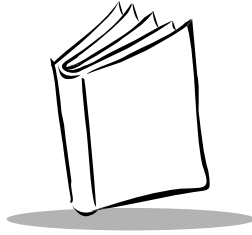

About This Manual

Introduction

The *P460/P360 Memory Scanners Product Reference Guide* provides general instructions for setup, operation, troubleshooting, maintenance, and programming the Phaser Batch scanners.

Chapter Descriptions

- [Chapter 1, *The Phaser Series Scanner*](#), describes the scanner and Quick Start Up Instructions.
- [Chapter 2, *Set Up*](#), explains how to set up the scanner.
- [Chapter 3, *Operation*](#), explains how to operate the scanner.
- [Chapter 4, *Maintenance And Specifications*](#), talks about the maintenance and the specifications of the scanner and the cradle.
- [Chapter 5, *Parameter Menus*](#), has all the optional parameter bar codes for personalizing your scanner.
- [Appendix A, *Bar Code Information*](#), has information about bar codes.
- [Appendix B, *Automatic Project Download*](#), describes the AutoLoad feature.
- [Appendix C, *Messages and Error Codes*](#), describes the messages and error codes displayed on the scanner.

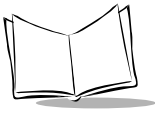

Notational Conventions

The following conventions are used in this document:

- *Italics* are used to highlight specific items in the general text, and to identify chapters and sections in this and related documents. It also identifies names of windows, menus, menu items, and fields within windows.
- **Bold** identifies buttons to be tapped or clicked.
- Bullets (•) indicate:
 - lists of alternatives or action items.
 - lists of required steps that are not necessarily sequential.
- Numbered lists indicate a set of sequential steps, i.e., those that describe step-by-step procedures.

Related Publications

- *P460/P360 Memory Scanners Quick Reference Guide*, p/n 70-33628-xx
- *PL 460 Cradle Quick Reference Guide*, p/n 70-33657-xx
- *MCL Designer for Phaser Series User's Guide*, p/n 70-37689-xx

Service Information

If you have a problem with your equipment, contact the [Symbol Support Center](#) for your region. See [page xi](#) for contact information. Before calling, have the model number, serial number, and several of your bar code symbols at hand.

Call the Support Center from a phone near the scanning equipment so that the service person can try to talk you through your problem. If the equipment is found to be working properly and the problem is symbol readability, the Support Center will request samples of your bar codes for analysis at our plant.

If your problem cannot be solved over the phone, you may need to return your equipment for servicing. If that is necessary, you will be given specific directions.

Note: *Symbol Technologies is not responsible for any damages incurred during shipment if the approved shipping container is not used. Shipping the units improperly can possibly void the warranty. If the original shipping container was not kept, contact Symbol to have another sent to you.*

Symbol Support Center

For service information, warranty information or technical assistance contact or call the Symbol Support Center in:

United States

Symbol Technologies, Inc.
One Symbol Plaza
Holtsville, New York 11742-1300
Tel: 1-800-653-5350

United Kingdom

Symbol Technologies
Symbol Place
Winnersh Triangle, Berkshire RG41 5TP
United Kingdom
Tel: 0800 328 2424 (Inside UK)
Tel: +44 118 945 7529 (Outside UK)

Australia

Symbol Technologies Pty. Ltd.
432 St. Kilda Road
Melbourne, Victoria 3004
Tel: 1-800-672-906 (Inside Australia)
Tel: +61-3-9866-6044 (Outside Australia)

Denmark/Danmark

Symbol Technologies AS
Dr. Neergaardsvej 3
2970 Hørsholm
Tel: 7020-1718 (Inside Denmark)
Tel: +45-7020-1718 (Outside Denmark)

Canada

Symbol Technologies Canada, Inc.
2540 Matheson Boulevard East
Mississauga, Ontario, Canada L4W 4Z2
Tel: 905-629-7226

Asia/Pacific

Symbol Technologies Asia, Inc (Singapore Branch)
230 Victoria Street #05-07/09
Bugis Junction Office Tower
Singapore 188024
Tel: +65-6796-9600
Fax: +65-6337-6488

Austria/Österreich

Symbol Technologies Austria GmbH
Prinz-Eugen Strasse 70 / 2.Haus
1040 Vienna, Austria
Tel: 01-5055794-0 (Inside Austria)
Tel: +43-1-5055794-0 (Outside Austria)

Europe/Mid-East Distributor Operations

Contact your local distributor or call:
Tel: +44 118 945 7360

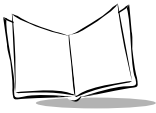

Finland/Suomi

Oy Symbol Technologies
Kaupintie 8 A 6
FIN-00440 Helsinki, Finland
Tel: 9 5407 580 (Inside Finland)
Tel: +358 9 5407 580 (Outside Finland)

Germany/Deutschland

Symbol Technologies GmbH
Waldstrasse 66
D-63128 Dietzenbach, Germany
Tel: 6074-49020 (Inside Germany)
Tel: +49-6074-49020 (Outside Germany)

Latin America Sales Support

2730 University Dr.
Coral Springs, FL 33065 USA
Tel: 1-800-347-0178 (Inside United States)
Tel: +1-954-255-2610 (Outside United States)
Fax: 954-340-9454

Netherlands/Nederland

Symbol Technologies
Kerkplein 2, 7051 CX
Postbus 24 7050 AA
Varsseveld, Netherlands
Tel: 315-271700 (Inside Netherlands)
Tel: +31-315-271700 (Outside Netherlands)

France

Symbol Technologies France
Centre d'Affaire d'Antony
3 Rue de la Renaissance
92184 Antony Cedex, France
Tel: 01-40-96-52-21 (Inside France)
Tel: +33-1-40-96-52-50 (Outside France)

Italy/Italia

Symbol Technologies Italia S.R.L.
Via Cristoforo Colombo, 49
20090 Trezzano S/N Navigilo
Milano, Italy
Tel: 2-484441 (Inside Italy)
Tel: +39-02-484441 (Outside Italy)

Mexico/México

Symbol Technologies Mexico Ltd.
Torre Picasso
Boulevard Manuel Avila Camacho No 88
Lomas de Chapultepec CP 11000
Mexico City, DF, Mexico
Tel: 5-520-1835 (Inside Mexico)
Tel: +52-5-520-1835 (Outside Mexico)

Norway/Norge

Symbol's registered and mailing address:
Symbol Technologies Norway
Hoybratenveien 35 C
N-1055 OSLO, Norway
Symbol's repair depot and shipping address:
Symbol Technologies Norway
Enebakkveien 123
N-0680 OSLO, Norway
Tel: +47 2232 4375

South Africa

Symbol Technologies Africa Inc.
Block B2
Rutherford Estate
1 Scott Street
Waverly 2090 Johannesburg
Republic of South Africa
Tel: 11-809 5311 (Inside South Africa)
Tel: +27-11-809 5311 (Outside South Africa)

Sweden/Sverige

“Letter” address:

Symbol Technologies AB
Box 1354
S-171 26 SOLNA
Sweden

Visit/shipping address:

Symbol Technologies AB
Solna Strandväg 78
S-171 54 SOLNA
Sweden

Tel: Switchboard: 08 445 29 00 (domestic)
Tel: Call Center: +46 8 445 29 29 (international)
Support E-Mail:
Sweden.Support@se.symbol.com

If you purchased your Symbol product from a Symbol Business Partner, contact that Business Partner for service.

For the latest version of this guide go to:<http://www.symbol.com/manuals>.

Spain/España

Symbol Technologies S.L.
Avenida de Bruselas, 22
Edificio Sauce
Alcobendas, Madrid 28108
Spain
Tel: 91 324 40 00 (Inside Spain)
Tel: +34 91 324 40 00 (Outside Spain)
Fax: +34.91.324.4010

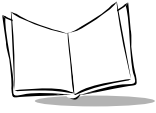

P460/P360 Memory Scanners Product Reference Guide



Chapter 1

The Phaser Series Scanner

Introduction

The P460/P360 Memory Scanners bring new flexibility and economy to data capture and data management in both retail and industrial operations. In addition to an integrated bar code scanner, the Phaser has an on-board keyboard and display. They can operate in both corded and battery-powered cordless modes. There are many versions available:

- 1D P 460: the batch retail version
- 1D P 360: the batch industrial version

Unless otherwise noted, the term Phaser refers to all versions of the scanner.

Rechargeable Battery

In the handle of the scanner, there is a rechargeable lithium-ion battery. This provides all power to the scanner during cordless operation. It provides 12 hours of use in a typical application.

When fully depleted, the battery can be recharged to full charge in about 3-1/2 hours.

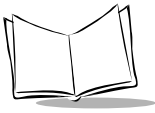

The Cradle

The PL 460 and PL 360 Cradles act as a:

- stand
- communication interface with the host
- battery charger for the Phaser Batch Scanner.

Note: The scanner battery can also be charged without a cradle by using an RS-232 cable and a power supply.

The cradle can sit on a desktop or be wall-mounted, whichever is more convenient. It receives data from the scanner via connectors in the bottom of the scanner and the top of the cradle. It then transmits that data to the host device through an attached cable. It also acts as a holder for the scanner.

The cradle also provides power for charging the scanner's battery (in the scanner). The cradle has a charge status indicator light that shows the status of the battery charging (Refer to [Table 2-1 on page 2-6](#)).

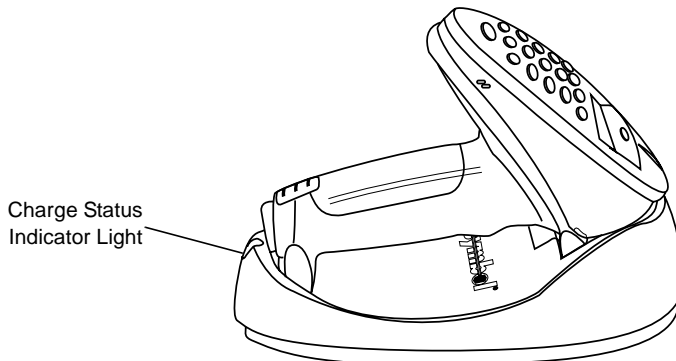

Figure 1-1. Scanner and Cradle

There are two versions of the cradle:

- PL 460 Cradle: batch retail version
- PL 360 Cradle: batch industrial version.

Unless otherwise noted, the term Cradle refers to both versions of the cradle.

Quick Startup Instructions

Below is an index of Quick Startup Instructions to help get you up and going quickly. These instructions are also on the back cover of this guide for easy reference. The index is listed in a step by step order beginning with step 1, Setting up the System.

Mandatory steps are designated by an asterisk (*). If an item has multiple pages referenced, the most important reference is in bold.

	PRG Page
1. Setting Up the System	
• Connecting to a host *	2-8
- Using a cradle	1-2, 2-4 , 3-6
- Using a cabled scanner	2-2 , 2-6
- RS-232 connection	2-8
- Synapse connection (keyboard wedge, USB, etc.)	2-9 , 2-10
• Charging the battery *	2-5 , 1-2
2. Using the Default Applications	
• Overview of Batch/Inventory application (Uncorded operation) *	3-2
- Reviewing/deleting stored records	3-5
- Transmitting batch/stored data to the host	3-6
• Overview of Scan and Transmit application (Corded operation) *	3-7
• Keypad operation	3-3, 3-26
• Eliminating repetitive scanning	3-4
• Selecting the host communication protocol	3-2, 3-9, 5-8 , 5-8
- RS-232 baud rate	5-83
3. Programming an Advanced Data Formatting Rule Using 123Scan	3-17
• Suffix values (appending Enter key and Tab)	3-18 , 3-20
4. Troubleshooting Problems	
• Troubleshooting table	4-2
• Messages and error codes	B-1
• Beeper indications	4-9
• Cradle LED indications	1-2, 2-6

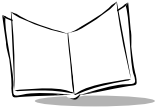

Commonly Used P460/P360 Programming Bar Code

Below are commonly used programming bar codes. You can cut this page out of the guide, or make a copy of the bar codes using a high quality copying machine.



Enter System Menu Bar Code



Load New MCL-Designer Application



Scanner Firmware Version



Load 123Scan File

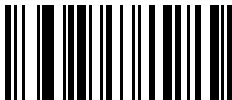

Reset Default Application
(Clears previously programmed ADF rules
and/or MCL-Designer applications)

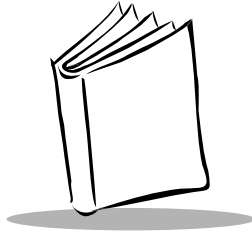

Chapter 2

Set Up

Introduction

This chapter covers the procedures for setting up the Phaser and its accessories.

Unpacking

Remove the scanner from its packing and inspect it for damage. If the scanner was damaged in transit, call one of the telephone numbers listed in the section [Symbol Support Center](#) on page xi. KEEP THE PACKING. It is the approved shipping container and should be used if you ever need to return your equipment for servicing.

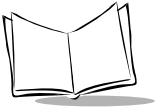

Cables

Connecting the Cable to the Scanner

1. Power down all devices that will be connected to the scanner.
2. Plug the modular connector on the cable into the receptacle in the bottom of the Phaser handle.

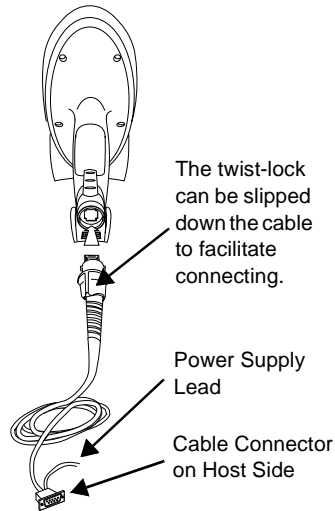

Figure 2-1. Connecting the Cable to the Phaser

3. Turn the cable twist-lock 1/8 turn clockwise to seat it.

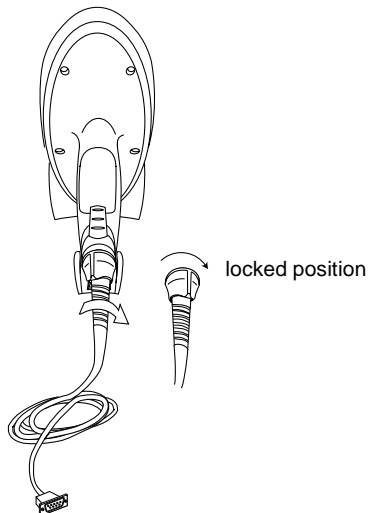

Figure 2-2. Locking the Cable to the Phaser

4. Gently pull the cable to make certain it is properly seated.

Disconnecting Cables from the Scanner

To disconnect the scanner cable:

1. Power down all the devices connected to the scanner.
2. Remove the cable by twisting the twist-lock 1/8 turn counter-clockwise and pulling the cable out.

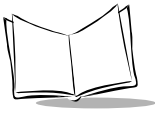

Setting Up the Cradle

On the bottom of the cradle are three ports. COM1 connects to the host computer, COM2 is used for daisy-chaining multiple base stations together, and the Power port supplies power to the cradle.

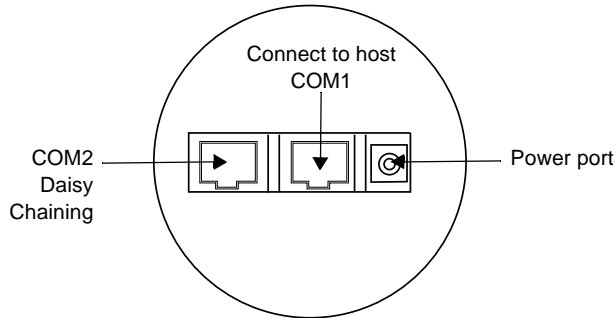

Figure 2-3. Ports on the Cradle

1. Connect an appropriate power supply to the Power port on the cradle. The indicator light on the cradle blinks, signifying successful power-up.

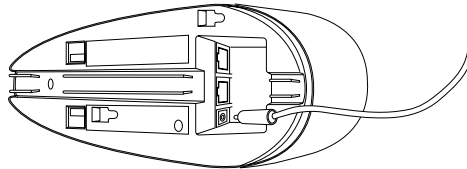

Figure 2-4. Power Supply Port

2. Insert the cable from the host computer into COM1.

If daisy chaining multiple cradles, connect the daisy chaining cable to COM2. For additional information on daisy chaining, see *Daisy-Chaining Cradles* on page 3-6.

Scanner Power Options

Two power options are available:

- Battery
- Power Supply (“Charging”) Cable

Charging the Battery

Before its first use, the scanner battery may need to be charged. It can be charged:

- Using the cradle
- Using a cable
- Using the UBC 2000.

Note: For a battery already in use, when the battery's charge is almost depleted, the scanner emits 4 high tone beeps, when the trigger is pulled, indicating that it must be recharged.

Charging Using the Cradle

1. Connect the power supply to the power input jack on the cradle.
2. Connect the power supply to a receptacle supplying AC power of the proper voltage level.
3. Insert the scanner into the cradle so that the nose of the scanner and tip of the handle seat into the receptacles. The scanner displays "UNIT CRADLED" when properly inserted in the cradle.

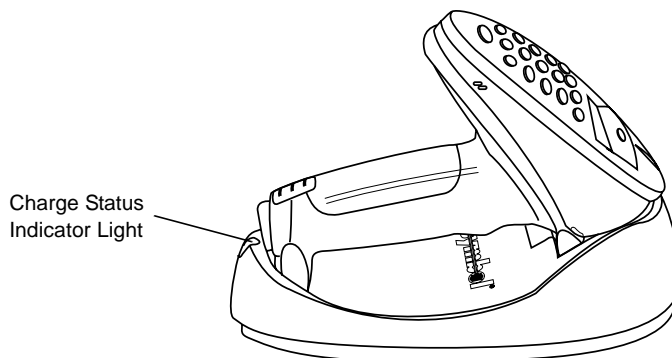
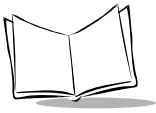

Figure 2-5. Placing the Scanner into the Cradle

4. Check the charge status indicator light. For additional information on charging, see [Table on page 2-6](#).
5. The battery charges automatically. A full charge of a depleted battery takes approximately 3-1/2 hours.



The cradle recharges batteries in the scanner only when the scanner is in the cradle. A scanner with a depleted battery starts charging immediately upon insertion into the cradle, whereas a scanner with a partially charged battery begins charging after approximately 15 minutes. Note that the scanner can be removed from the cradle at any time.

Charging Using a Cable

1. Connect the cable to the scanner.
2. Connect the power supply to the power jack on the cable.
3. Connect the power supply to a receptacle supplying AC power of the proper voltage level.
4. The battery charges automatically. A full charge of a depleted battery takes approximately 3-1/2 hours.

Charging Using the UBC 2000

The battery can be charged using the Universal Battery Charger UBC 2000. The UBC adapter for the P460/P360/P470/P370 scanner battery is required. Refer to the UBC 2000 guide for information on recharging the battery using the UBC 2000.

Charge Status LED Indications

The LED indicator on the cradle uses flashing patterns to display the charger status, as shown in the table below.

Table 2-1. Cradle LED Indications

LED	Status
Off	The scanner is not in the cradle or has not been properly inserted into the cradle.
Blinking Slowly	The scanner is properly seated in the cradle and charging will begin shortly.
Blinking Rapidly	The battery is actively charging.
On	Battery charging is complete.

Changing the Battery

Once a battery is fully charged, it will generally last up to 12 hours without being returned to the cradle. By returning it to the cradle during the day, you extend this time.

If a significant decrease in battery life is noticed and does not correspond to increased usage, consider replacing the battery.

Removing the Battery

1. Slide the release latch down using center indent and remove the cover.

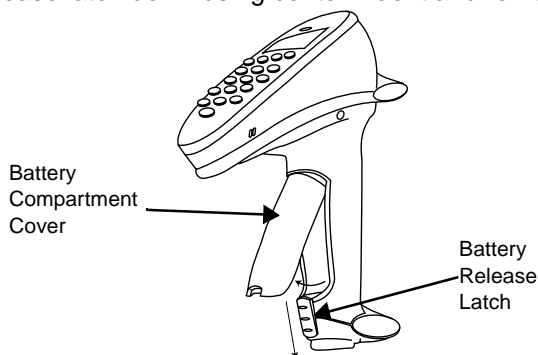

Figure 2-6. Removing the Battery Compartment Cover

2. Slide the battery toward the bottom of the scanner and then pull the bottom of the battery back and out of the scanner.

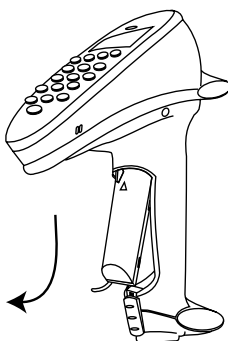
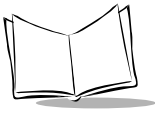

Figure 2-7. Pulling the Battery Out



Inserting the Battery

1. Place the top portion of the battery (curved side up, contacts toward top) into the scanner and then slide it up the handle.
2. Replace the battery compartment cover.
3. Slide the release latch up to secure the cover in place.

Connecting to a Host

When Using the Scanner as a Batch Device

When using the scanner as a batch device (uncorded) running off its battery, you can transmit stored data to a host in one of two ways:

- through a cable connected directly to the scanner
- through a cradle.

When Using the Scanner as a Corded Device

When using the scanner as a corded device, power and host communications take place using a cable.

RS-232 Communication with a Host

1. Make sure all host devices are powered down.
2. Plug the communication cable's connector into an appropriate RS-232 (serial) port on the host device.
3. If using a cradle for communication, plug the power supply lead into the Power port on the bottom of the cradle.

If using a cable directly connected to the scanner, plug the power supply lead into the power port on the cable's connector (see [Figure 2-1 on page 2-2](#)).

4. Connect the power supply into an AC receptacle.

Using A Synapse Cable with the cradle

1. Make sure all host devices are powered down.

IMPORTANT

Before power is provided to the cradle (step 6), the following steps must be completed. The Synapse cable must be connected to the cradle (step 2) AND the flying power lead plugged in (step 4). If the cables are not connected in this sequence, the Synapse Interface Adapter will not operate properly.

2. Connect the Synapse cable to the cradle COM1 port (see [Figure 2-3 on page 2-4](#)).
3. Connect the other end of the Synapse cable to the Synapse Interface adapter.
4. The Synapse cable has a flying power lead. Connect this lead to the receptacle in the Synapse Interface adapter, as shown in [Figure 2-8](#). See the Synapse guide for details.

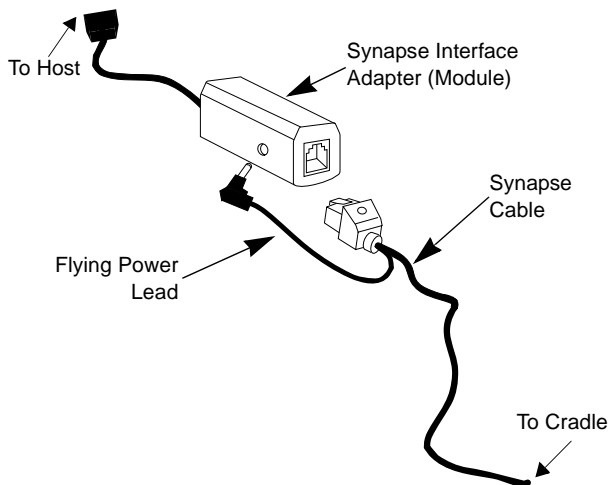
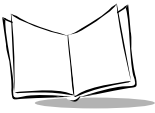

Figure 2-8. Synapse and Adapter Cable

5. Connect the Synapse Interface adapter to the host.
6. Connect the power supply to the cradle (see [Figure 2-3](#) and [Figure 2-4](#)).
7. Connect the appropriate line cord to the power supply and into an AC receptacle.
8. The indicator light on the cradle blinks, signifying successful power-up.
9. Scan the appropriate Synapse bar codes to set up the Synapse cable for your specifications.



Using A Synapse Cable with the Scanner

1. Make sure all host devices are powered down.

IMPORTANT

Before power is provided to the scanner (step 6), the following steps must be completed. The Synapse cable must be connected to the scanner (step 2) **AND** the flying power lead plugged in (step 4). If the cables are not connected in this sequence, the Synapse Interface Adapter will not operate properly.

2. Connect the Synapse cable into the bottom of the scanner.
3. Connect the other end of the Synapse cable to the Synapse Interface adapter.
4. The Synapse cable has a flying power lead. Connect this lead to the receptacle in the Synapse Interface adapter, as shown in [Figure 2-9](#). See the Synapse guide for details.

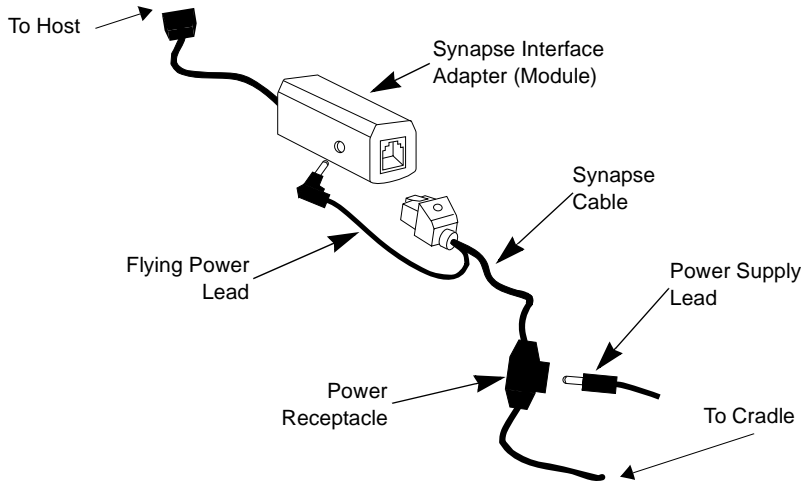
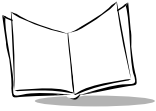

Figure 2-9. Synapse and Adapter Cable

5. Connect the Synapse Interface adapter to the host.
6. Connect the standard Phaser memory scanner power supply to the power receptacle in the Synapse cable.
7. Connect the appropriate line cord to the power supply and into an AC receptacle.
8. Scan the appropriate Synapse bar codes to set up the Synapse cable for your specifications.

Wand Emulation, OCIA, OCR, Keyboard Wedges

See the instructions packed with the appropriate Synapse cable. An adapter cable is required. See [Figure 2-8 on page 2-9](#).



P460/P360 Memory Scanners Product Reference Guide

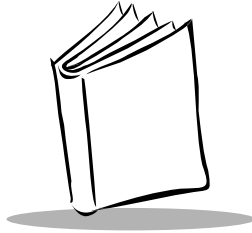

Chapter 3 *Operation*

Introduction

This chapter covers how to use the Phaser scanner.

Default Applications

The Memory Phaser is shipped from the factory with two ready to use default applications:

- Scan and Transmit
- Batch / Inventory

These applications allow users to scan and view data, enter quantities, manually enter data, and much more.

When the unit is powered up, it displays the system start-up banner. Alternatively, the scanner can be reset manually by pressing the <FUNC> key, then the <*> key. When the scanner is powered up or reset, the system banner appears as follows:

Symbol Technologies
Phaser Memory Scnr

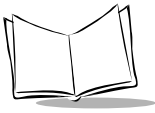

Initial Powerup

After a few seconds, the System Banner is replaced by the system initialization screen.

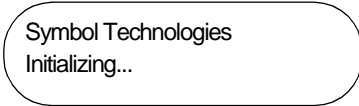

Symbol Technologies
Initializing...

After initialization, the scanner enters either the Scan & Transmit mode, or the Batch/Inventory mode, depending on whether a communications cable is present or not. The default communication protocols are:

- *RS-232/Synapse* - Scan & Transmit application
- *RS-232/Synapse* - Batch/Inventory application

If a Synapse cable is attached, the scanner automatically overrides the default settings.

Batch / Inventory Application

The batch/inventory application is a scan-and-store application that allows you to:

- Display and store (Batch) data for transmission later
- Eliminate repetitive scanning with a quantity entry feature
- Manually enter alphanumeric data if no bar code is present
- Review and delete stored records
- Transmit stored (batch) data to a host.

The scanner automatically detects and switches to batch/inventory mode operation when it is removed from the cradle or its cable is disconnected.

The following Batch/Inventory screen appears:

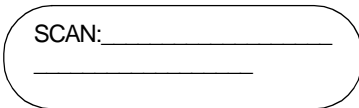

SCAN: _____

Scanned bar code data is automatically displayed and stored for review/transmission to a host at a later date.

If the scanner powers down, pull the trigger or press the <ENTER> key to wake it up.

Numeric Data Entry

The default application also allows you to manually enter data if no bar code is present.

By default, this feature is enabled. To disable alphanumeric data entry via the keypad, go to the symbologies tab inside 123Scan and remove the “X” from the check box next to “Keypad”. (This does not disable the quantity entry feature discussed in *Eliminating Repetitive Scanning* on page 3-4.)

With keypad entry enabled (default setting out of the box), press the <ENTER> key after keying in data. During data entry, the <BK> key corrects keying errors digit by digit, and the <FUNC> key then <BK> key combination clears the screen so you can start over. If your entry exceeds 34 characters, the characters will scroll off the visible portion of the screen, but are retained for storage.

Alpha Data Entry

To enter alpha characters via the keypad (with keypad enabled, page 3-26), press the <Mode> key once to put the scanner in Alpha Mode.

Numeric buttons 1 through 9 are associated with the alpha characters. For example, the letters A, B and C are located on numeric button 7. Press the button with the letter you desire - once for the letter A, twice for the letter B, or three times for the letter C. You can continue entering alpha characters or switch to numerics. Press <ENTER> to send the data.

To return to numeric entry mode after entering alpha characters, press the <Mode> key again. For example, to manually enter **17ABF5**, do the following steps:

Data	Action
1	Press numeric button 1.
7	Press numeric button 7.
A	Press <MODE> button once, then numeric button 7 once. Wait for one second (you will hear a low pitched beep).
B	Press numeric button 7 twice.
F	Press numeric button 8 three times.
5	Press <MODE> button once, then numeric button 5 once, then <ENTER>.

For more information, refer to *Keypad Operation* on page 3-26.

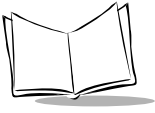

Eliminating Repetitive Scanning

To eliminate repetitive scanning of identical items, you can enter a quantity prior to scanning a bar code. This quantity entry feature can also be used when manually entering bar code data.

To enter a quantity, press the * key. The following screen with a default value of “1” will appear:

Quantity:
1^_____

To enter the value you desire, key in the quantity followed by the <ENTER> key. Next, the bar code data entry screen reappears. Scan the item’s bar code. The scanner sends the bar code data to the host the keyed-in amount of times. For instance, if you type in a quantity of 6 then scan a bar code, the scanner sends that bar code data to the host six times as if the bar code had been scanned six times.

If you have accidentally entered this screen, it will automatically be exited after 5 seconds or by pressing the <ENTER> key without entering a quantity.

Reviewing and Deleting Stored Records

While running the Batch/Inventory application, you can review and delete stored data. Press the <FUNC> key, then the <2> key to enter this mode. The following screen appears:

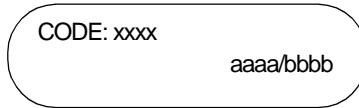

CODE: xxxx
aaaa/bbbb

Three fields are shown on this screen:

xxxx = the data contained within the record (the first 25 characters)

aaaa = the index number of the record being viewed

bbbb = the total number of records stored in memory

Use the up Δ and down ∇ arrow keys to scroll through the stored data. Press the <ENTER> key at any time to exit the review records mode.

To select the record being viewed for deletion, press the <BK> key. A confirmation screen displays:

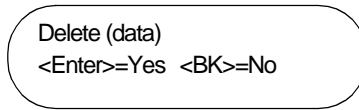

Delete (data)
<Enter>=Yes <BK>=No

Then press the <Enter> key to delete the selected record or the <BK> key to keep (retain) the record.

If a record is deleted, the total number of records (bbbb) displayed on the bottom right of the review screen will not change. For example, if five records have been scanned and stored in memory and the third record is deleted, the review screen will continue to display the total number of records stored in memory as five. But a review of the individual records will show no third record existing. The reviewed records index from the second record (2/5) to the fourth record (4/5), skipping the deleted third record (3/5).

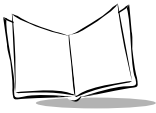

Transmitting Batch/Stored Data to the Host

When you are ready to transmit your stored (Batch) data to the host, press the <FUNC> key, then the <1> key. Then, place the scanner in the cradle or connect a communication cable.

Note: *When attached to a cable, the scanner will automatically begin running the Scan & Transmit application. The stored (Batch) data will not be transmitted to the host until the <FUNC> key, then the <1> key are entered.*

When the screen below appears, the scanner is ready to initiate the transfer. You have 30 seconds to either insert the scanner into a cradle or attach a communications cable. If you fail to do so, a retry screen will appear.

Status:
Connect unit to host

To exit this mode and prevent the transmission of stored (Batch) data to the host, press the <FUNC> key then the <BK> key. After the stored data is transmitted to the host, the following screen appears:

Finished. Clear Data
<Enter>=Yes <BK>=No

Press the <ENTER> key to clear the transmitted records/data from the scanner's memory. Press the <BK> key to retain records/data in the scanner's memory. If you press the <BK> key, any subsequent scanned bar codes are appended to the end of the existing data.

Daisy-Chaining Cradles

Up to 12 cradles can be connected in series (daisy-chained) to communicate through a single serial port. This out-of-the-box capability is a standard feature of the Phaser memory scanner's default Batch/Inventory application. To enable it, simply daisy-chain the cradles together through COM2. See *Setting Up the Cradle* on page 2-4 for more details. Each cradle still requires its own power supply.

Optional - To establish which scanner the data originated from, and to prevent a buffer over-write, the scanner ID of daisy-chained scanners must be changed from the factory default of 001 to a unique number. For information on how to set the scanner ID/scanner address, see *Scanner Address* on page 5-98.

If a scanner is placed in a daisy-chained cradle while another scanner is transferring data to the host, the second scanner will begin its data transfer after the first scanner's transfer is completed.

Scan and Transmit Application

The scan and transmit application allows you to:

- Display and simultaneously transmit data to a host
- Eliminate repetitive scanning with a quantity entry feature
- Manually enter alphanumeric data if no bar code is present.

The scanner automatically switches to scan and transmit operation when a cable is attached.

The scan and transmit screen appears as follows:

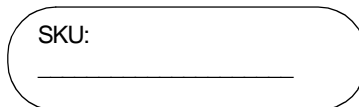

SKU:

In this mode, scanned bar codes are automatically transmitted to the host in real time.

Alphanumeric data may be manually entered in the same manner as described in the *Batch / Inventory Application* on page 3-2. Keyed data transmits once you press the <ENTER> key.

To eliminate repetitive scanning, you can enter a quantity prior to scanning a bar code. Refer to *Eliminating Repetitive Scanning* on page 3-4.

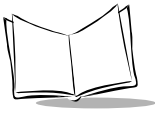

System Menu

The system menu allows the user to set up the operation of the scanner, such as loading a new application, erasing files, setting the scanner ID, etc.

Enter System Menu by scanning the bar code below or by entering a keypad sequence.

Note: Commonly used System Menu programming bar codes have been consolidated on page 1-4



Enter System Menu Bar Code

To access the System Menu using the keypad sequence, press the <FUNC>, then the <*> key, followed by the <FUNC> key, then the <BK> key.

When you enter the system menu, the following screen appears:

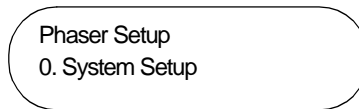

Below is the list of available options. Press the Up Δ and Down ∇ arrow keys to scroll through them. Press <ENTER> to select a menu option. You can also select a menu option by typing the associated menu option number and then pressing <ENTER>.

- 0. System Setup
- 1. App. Control
- 2. Parameter Control
- 3. System Status
- 4. Erase File
- 5. Version
- 9. Return to App

The system menu options are described below.

System Setup

System Setup allows you to configure the scanner's basic settings such as date and time.

Option	Description
<p>0. Set Com Protocol 0. Scan & Transmit -MCL NET -RS232/Synapse -Back to Com Protocol</p> <p>1. Batch/Inventory -MCL NET -RS232/Synapse -Back to Com Protocol</p> <p>9. Back to Main</p>	<p>Sets the communication protocol used by the default applications. The options are MCL-Net or RS-232/Synapse. If RS-232/Synapse is selected, the scanner automatically identifies whether an RS-232 or Synapse interface is required.</p> <p>The communication protocol can be set independently for the Scan & Transmit and Batch/Inventory applications. For example, you can set the Scan & Transmit application to RS-232 and the Batch/Inventory to MCL NET.</p> <p>To cancel the change, press the <FUNC> then <BK> keys, or to accept the change, press the <ENTER> key.</p>
<p>1. Set Date</p>	<p>Sets the date of the internal clock of the scanner. The scanner displays its current date and provides a prompt for the user to enter the new date. The date format is mm/dd/yyyy.</p> <p>To cancel the change, press the <FUNC> then <BK> keys, or to accept the change, press the <ENTER> key.</p>
<p>2. Set Time</p>	<p>Sets the time of the internal clock of the scanner. The scanner displays its current time value, and provides a prompt for the user to enter the new time. The time format is HH:MM:SS entered in military time. For example, to enter 11:25PM, enter 23:25:00.</p> <p>To cancel the change, press the <FUNC> then <BK> keys, or to accept the change, press the <ENTER> key.</p>
<p>3. Set Contrast</p>	<p>Sets the display contrast. The scanner displays the current contrast setting. Use the up and down arrow keys to change the contrast. The default contrast is 7, and the range is from 0 to 15, with 0 being the lightest and 15 being the darkest.</p> <p>To cancel the change, press the <FUNC> then <BK> keys, or to accept the change, press the <ENTER> key.</p>
<p>4. Set Scanner ID</p>	<p>Sets the scanner ID. The scanner displays its current ID, and the user may key in a new value between 1 and 254. The default is 001.</p> <p>To cancel the change, press the <FUNC> then <BK> keys, or to accept the change, press the <ENTER> key.</p>
<p>9. Back to Main</p>	<p>Returns the user to the system menu.</p>

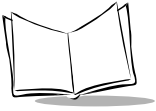

Note: *The scanner contains a backup power source to retain the time and date information for up to 24 hours after loss of battery power. If battery power is not restored within 24 hours, time and date information will be lost.*

App. Control

App. Control allows you to control your application, specifically, load new system application files on your scanner, reset your default applications, etc.

You can load a new application/file or system code by either scanning the appropriate bar code or entering the appropriate keypad value as indicated on the display.

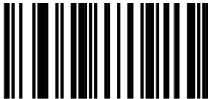
Option	Description
<p>0. Load App / File</p>	<p>Puts the scanner into a mode to receive MCL-Designer application downloads, file updates, and MCL-Link commands from the host.</p> <p>To enter this mode using the key pad, select this option on the system menu. The following screen displays:</p> <div data-bbox="680 662 1036 764" style="border: 1px solid black; border-radius: 15px; padding: 10px; margin: 10px auto; width: fit-content;"> <p>Load New App/File <Enter>=Yes <BK>=No</p> </div> <p>OR</p> <p>To enter this mode from an application without entering the system menu, scan the bar code below.</p> <div data-bbox="744 911 950 1008" style="text-align: center;">  </div> <p style="text-align: center;">Load New Application/File</p> <div data-bbox="680 1101 1036 1203" style="border: 1px solid black; border-radius: 15px; padding: 10px; margin: 10px auto; width: fit-content;"> <p>Status: Connect unit to host</p> </div> <p>When this screen displays, the scanner is ready to accept the download. On the PC Utility, initiate the download.</p> <p>After downloading is complete, the system menu is exited and the application initiated.</p> <p>To exit this mode and prevent the download of a new application, press the <FUNC> then <BK> keys.</p>

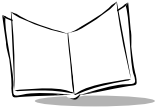

Option	Description
1. Set Default App	<p>Reinstalls the default application and returns all parameters to their factory settings (values listed in Table 5-1). The default application overwrites any MCL-Designer application and/or ADF rules. This option may be used to restore functionality to a scanner which has been loaded with a defective application.</p> <p>To enter this mode using the key pad, select this option on the system menu. Prior to resetting the default application, the user is prompted to confirm this operation:</p> <div data-bbox="628 500 989 605" style="border: 1px solid black; border-radius: 15px; padding: 10px; text-align: center;"><p>Reset Default App? <Enter>=Yes <BK>=No</p></div> <p>Press the <ENTER> key to confirm the choice (Yes) or the <BK> key to cancel the choice (No).</p> <p>If you entered “Set Default App” from the System Menu, upon resetting the default application, you will return to the System Menu.</p> <p>OR</p> <p>To enter this mode from an application without entering the system menu, scan the bar code below.</p> <div data-bbox="683 930 915 1013" style="text-align: center;"></div> <p style="text-align: center;">Reset Default Application (Clears previously programmed ADF rules and/or MCL-Designer applications)</p> <p>If you entered the “Set Default App” mode using the bar code above, the default application will automatically be reset, the System Menu exited, and the application re-initiated.</p>

Option	Description
<p>2. System Code</p>	<p>Updates the scanner operating system (Firmware). An RS-232 cable is required. It connects the scanner (not the cradle) to the host. To enter this mode using the key pad, select this option on the system menu.</p> <div data-bbox="680 380 1038 483" style="border: 1px solid black; border-radius: 15px; padding: 5px; margin: 10px auto; width: fit-content;"> <p>Load New System Code <Enter>=Yes <BK>=No</p> </div> <p>Press the <ENTER> key to confirm the choice (Yes) or the <BK> key to cancel the choice (No).</p> <p>OR</p> <p>To enter this mode from an application without entering the system menu, scan the bar code below.</p> <div data-bbox="744 727 950 824" style="text-align: center;">  </div> <p style="text-align: center;">System Code</p> <div data-bbox="680 922 1038 1026" style="border: 1px solid black; border-radius: 15px; padding: 5px; margin: 10px auto; width: fit-content;"> <p>Attach RS232 Cable and Press ENTER</p> </div> <p>Attach the RS-232 cable and press <ENTER> to start the download.</p> <div data-bbox="680 1166 1038 1269" style="border: 1px solid black; border-radius: 15px; padding: 5px; margin: 10px auto; width: fit-content;"> <p>Scanner ready, On PC start download</p> </div> <p>After the download is complete, the system menu is exited and the application initiates. To exit this mode and prevent the download of new firmware, press and hold the <ENTER> key for 30 seconds.</p>
<p>9. Back to Main</p>	<p>Returns the user to the system menu.</p>

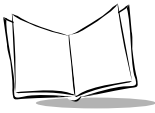

Parameter Control

Parameter Control allows you to control the scanner parameters such as Scan Parameters and Set Default Params.

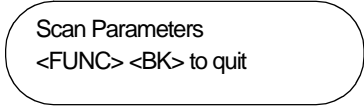
Option	Description
0. Scan Parameters	<p>This feature only works when used with an application generated with MCL-Designer and allows you to program your scanner by scanning the bar codes in Chapter 5, Parameter Menus. Parameters already set in your MCL-Designer generated application can not be overridden by scanning bar codes. When you see the following screen, you can begin scanning parameter bar codes:</p> <div style="text-align: center;"></div> <p>After scanning the desired bar codes, press <FUNC> then <BK> keys to exit this mode.</p>
1. Set Default Param	<p>Restores the default parameters in the scanner. The default parameters overwrite any scanned parameters. Prior to resetting the default parameters, you are prompted to confirm your choice.</p>
9. Back to Main	<p>Returns the user to the system menu.</p>

System Status

System Status allows you to perform system checks such as Battery Check.

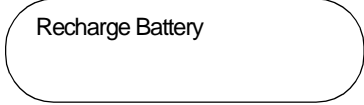
Option	Description
0. Battery Check	<p>Checks the battery charge level. Good indicates the battery does not require recharging. Low/Recharge indicates the scanner requires a recharge. When the battery is close to complete discharge, the following message displays:</p> <div style="text-align: center;"></div>
9. Back to Main	<p>Returns the user to the system menu.</p>

Erase File

Erase File	<p>Erase File allows you to erase your scanner batch data. It is recommended that data files be transferred from the scanner to the host before erasing. A screen prompts you to indicate which file is being erased. The batch/Inventory application data is always saved in file A.</p> <div data-bbox="647 410 1005 516" style="border: 1px solid black; border-radius: 15px; padding: 10px; text-align: center;"><p>File to Erase? (A-H)</p></div> <p>Enter the file name, (the name is a single letter between A and H), then press <ENTER> to erase the file.</p> <p>OR</p> <p>Press * to erase all files.</p>
-------------------	---

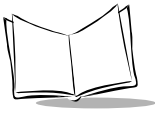

Version

Version	<p>This option displays the version of firmware (operating system) run by the scanner and the size of the scanner's memory, such as 1024k (1 MB). For example, the firmware version shown on the display below is NBRVSMAP, also called Revision "P" (which is the last letter of the firmware's full name).</p> <p>To enter this mode using the keypad, select this option on the System Menu. The following screen displays.</p> <div data-bbox="606 488 964 610" style="border: 1px solid black; border-radius: 15px; padding: 10px; text-align: center;"><p>Scanner: NBRVSMAP MCL: 4.x Mem: 1024</p></div> <p>If you entered "Version" from the System Menu, after 15 seconds or by pressing <ENTER>, you will return to the System Menu.</p> <p>OR</p> <p>To enter this mode from an application outside of the System Menu, scan the bar code below.</p> <div data-bbox="681 816 887 899" style="text-align: center;"></div> <p style="text-align: center;">Scanner Firmware Version</p> <p>If you entered "Version" using the bar code above, after 15 seconds or by pressing <ENTER>, you will automatically exit the System Menu and re-enter the application.</p>
----------------	---

Return to App

Return to App.	Return to App exits the system menu and returns to the application. To do this, press <9> then <ENTER>.
-----------------------	---

123Scan

123Scan is an intuitive Windows based utility that allows you to customize your scanner setup and generate Advanced Data Formatting (ADF) rules. An Advanced Data Formatting rule gives you the ability to modify the bar code data before sending it to the host such as appending a carriage return, or some other prefix/suffix value, to the bar code data. This enhances capability between bar code data and your host software, allowing you to program the scanner rather than modifying your host application. The scanner can be programmed via a serial (RS-232) download or by scanning 123Scan generated programming bar codes. Scanner programming is saved in a setup file which can be distributed electronically (Web site, floppy disk, or E-mail).

A copy of 123Scan is on the CD included with your scanner. It is also available on the Symbol Web site <http://www.symbol.com>. Use the web site's search tool to find "123Scan" and select the P460/360 product line.

Note: *Advanced data formatting rules created with 123Scan are for use with the default application only and will not work with applications created with MCL-Designer.*

To download a 123Scan generated ADF rule, scan the bar code below. Place the scanner in its cradle or attach an RS-232 cable. Then initiate the download on the PC utility.



Load 123Scan File

To remove previously programmed ADF rules from the scanner, scan the bar code below.



**Reset Default Application
(Clears previously programmed ADF rules)**

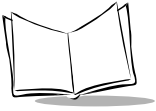

Suffix Values

123Scan generated programming bar codes for two commonly used suffixes (Enter and Tab) have been included in this Product Reference Guide.

To append an Enter key* to the transmitted bar code data, scan all nine (9) ADF rule bar codes and then the Reset Scanner bar code, in that order.

* ASCII value 7013

ADF Rules

1/9

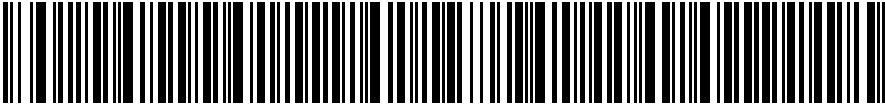

2/9

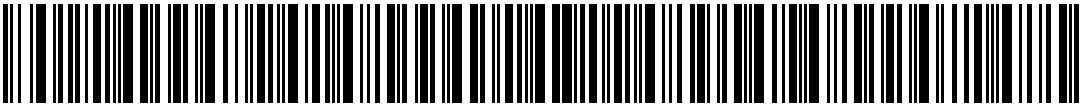

3/9

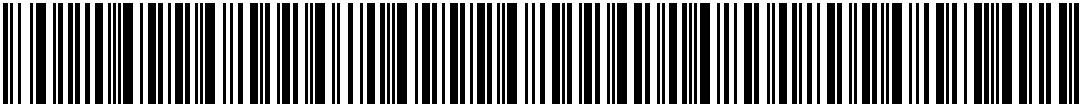

4/9



5/9

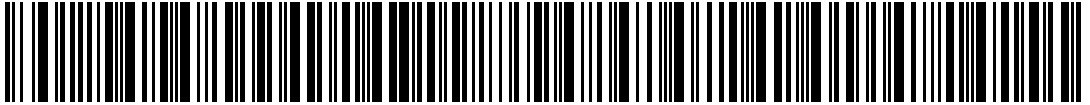

6/9

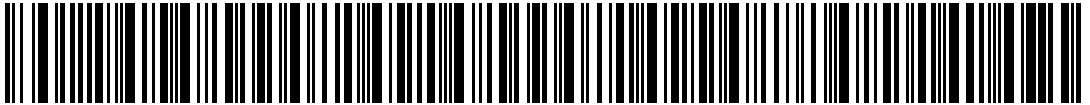

7/9

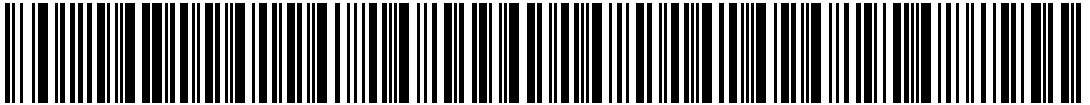

8/9



9/9



RESET SCANNER



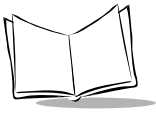

To **append a Tab*** to the transmitted bar code data, scan all nine (9) ADF rule bar codes and then the Reset Scanner bar code, in that order.

* ASCII value 7009

ADF Rules

1/9

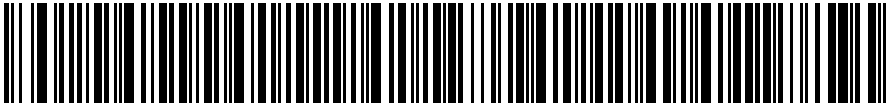

2/9

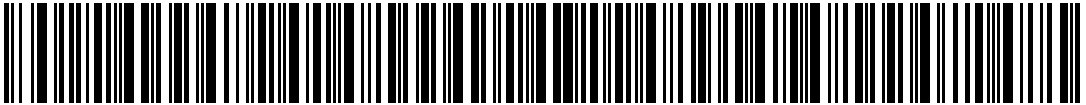

3/9

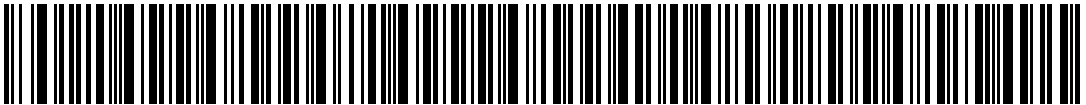

4/9



5/9



6/9

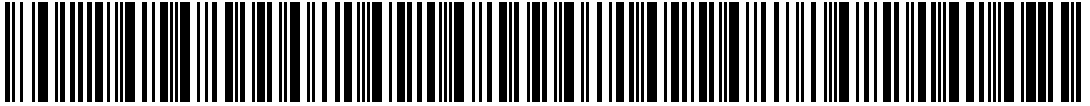

7/9



8/9

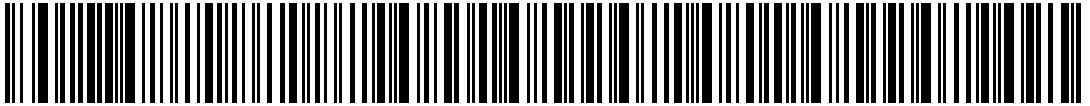

9/9

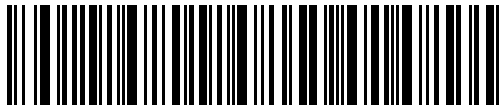

RESET SCANNER



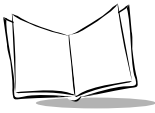

Scanning

The scanner ships with the default application and default parameters that is ready-to-use right out of the box. If this is not what you need for your application, refer to the *MCL Designer Manual* for programming instructions and [Chapter 5, Parameter Menus](#) for scanning and communications parameters. If you need assistance, contact your local supplier or Symbol Support Center.

1. If you are using the scanner in corded mode, make sure all cable connections are secure. Otherwise, make sure the battery is sufficiently charged.
2. Make sure the bar code is in the correct scanning range. Aim and press the trigger. The scanner has read the symbol when:
 - You hear a beep.
 - The LED above the screen turns green.
 - The red laser turns off.

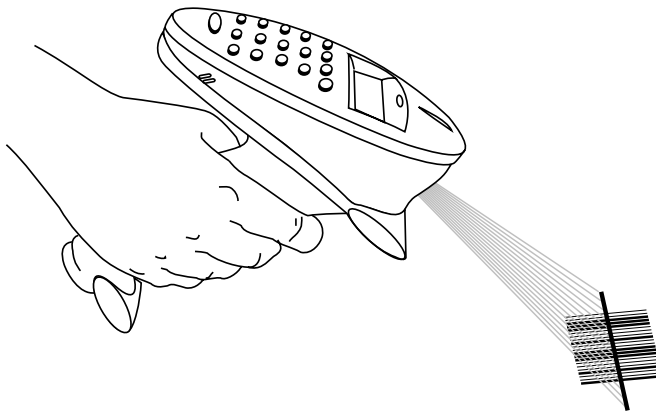

Figure 3-1. Scanning a Bar Code

Scan the Entire Symbol

- Your scan beam must cross every bar and space on the symbol.
- The larger the symbol, the farther away you should hold the scanner.
- Hold the scanner closer for symbols with bars that are close together.
- A short, high tone beep indicates a good decode.



Hold at an Angle

Do not hold the scanner directly over the bar code. Laser light reflecting *directly* back into the scanner from the bar code is known as specular reflection. This strong light can “blind” the scanner and make decoding difficult. The area where specular reflection occurs is known as a “dead zone.”

You can tilt the scanner up to 65° forward or back and still achieve a successful decode. Simple practice quickly shows what tolerances to work within.

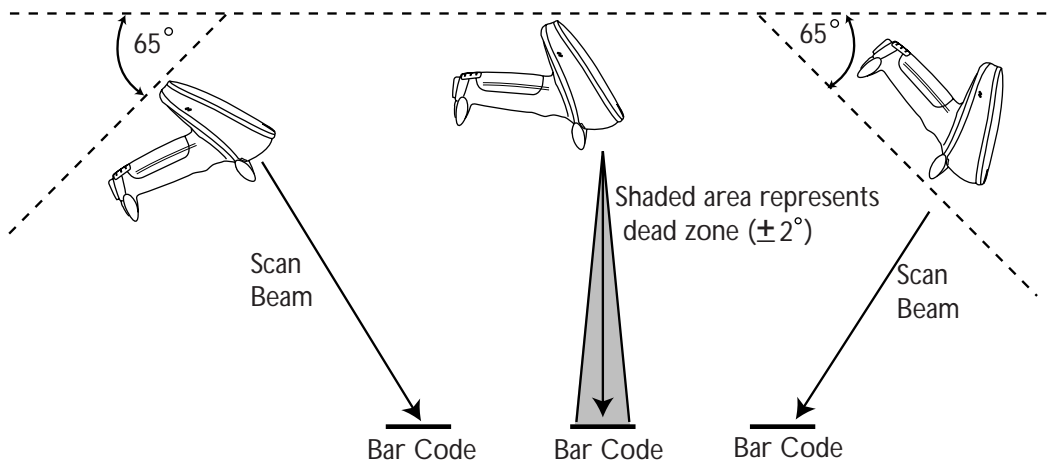
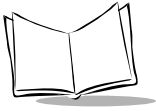

Figure 3-2. Maximum Tilt Angles and Dead Zone



Test Symbols

To ensure your scanner is working properly, try scanning the following bar codes. If you have trouble, refer to *Troubleshooting* on page 4-2.



01234567890

CODE 128



0 12345 67890 5

UPC

P460/P360 1D Scanner Decode Zone

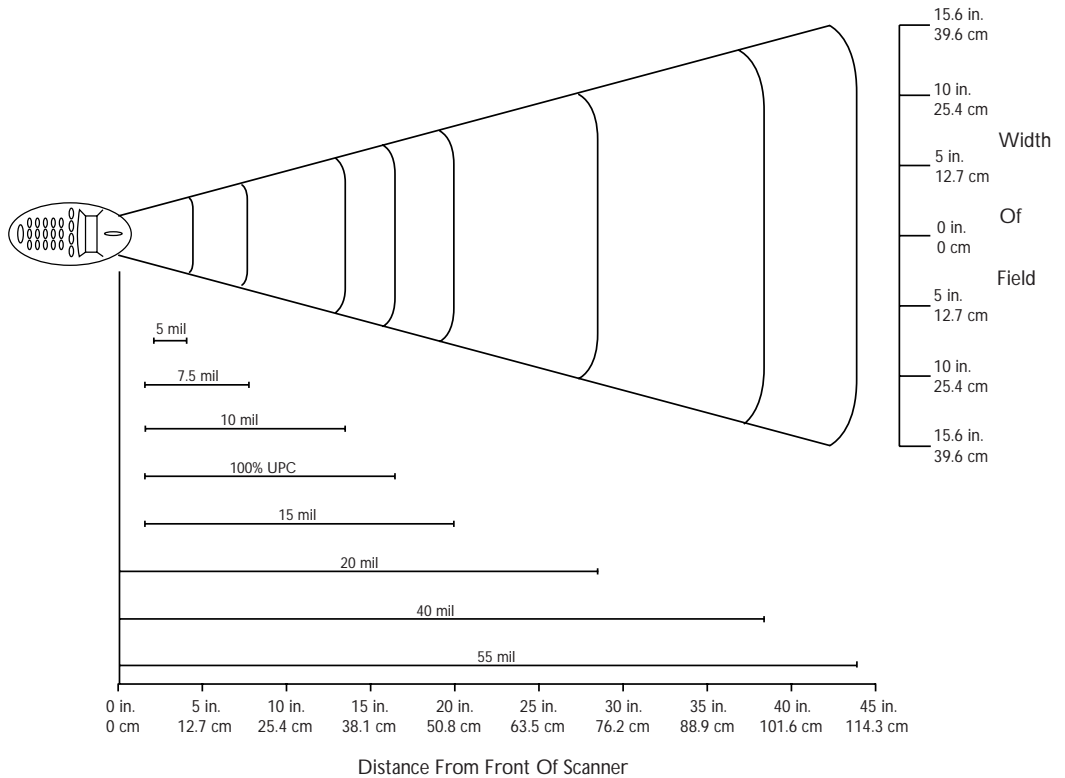
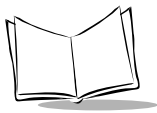

Figure 3-3. P460/P360 1D Scanner Decode Zone



Keypad Operation

Instead of scanning a bar code, you can enter the bar code data using the keypad on the top of the scanner. By default, this feature is enabled. To disable alphanumeric data entry via the keypad, go to the symbologies tab inside 123Scan and remove the “X” from the check box next to “Keypad”. (This does not disable the quantity entry feature discussed in *Eliminating Repetitive Scanning* on page 3-4.)

For additional information on 123Scan, see *123Scan* on page 3-17.

To enter numeric data, type the numeric value desired and press <ENTER>. A beep lets you know that the entry was accepted. See [Figure 3-4 on page 3-27](#).

To enter alpha characters, press the <Mode> key once to put the scanner in Alpha Mode.

Numeric buttons 1 through 9 are associated with the alpha characters. For example, the letters A, B and C are located on numeric button 7. Press the button with the letter you desire - once for the letter A, twice for the letter B, or three times for the letter C. You can continue entering alpha characters or switch to numerics. Press <ENTER> to save or send the data.

To return to numeric entry mode after entering alpha characters, press the <Mode> key again. For example, to manually enter **17ABF5**, do the following steps:

Data	Action
1	Press numeric button 1.
7	Press numeric button 7.
A	Press <MODE> button once, then numeric button 7 once. Wait for one second (you will hear a low pitched beep).
B	Press numeric button 7 twice.
F	Press numeric button 8 three times.
5	Press <MODE> button once, then numeric button 5 once, then <ENTER>.

Every time you press the button with the letter you desire, you hear a low-pitched beep to let you know that the entry was registered. Although the entry is registered, it has not been

transferred to the host yet. A high-pitched beep lets you know that the entry has been transferred to the host.

To return to numeric mode, press the Mode key again. Pressing the Enter key saves the data.

To put a decimal point (.) into numeric data, type in the numbers before the decimal point, then press the mode key, press the decimal, and press the mode key again. Now resume typing in the values to the right of the decimal.

To enter a dash (-), press the mode key once, then the zero (0) key twice.

To enter a blank space (), press the mode key once, then the zero (0) key three times.

The Function key in combination with a numeric key can be programmed to launch an operation, such as allowing you to review records. To use the Function key to review records, press the <FUNC> key, release it, and then press the <2> key. For more information on how to program these keys for additional tasks and operations, refer to the *MCL Designer User's Guide* p/n 70-37689-XX.

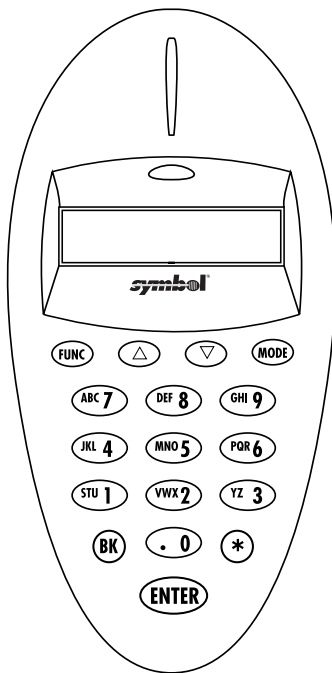
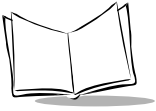
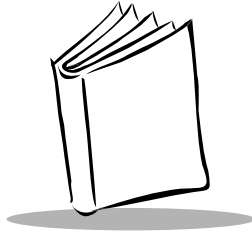

Figure 3-4. Scanner Keypad



P460/P360 Memory Scanners Product Reference Guide



Chapter 4

Maintenance And Specifications

Introduction

This chapter explains how to maintain your scanner and the specifications for it.

Maintenance

- Do not allow any abrasive material to touch the scanner window.
- Remove any dirt particles with a damp cloth.
- Wipe the scanner window using a damp cloth, and if necessary, a non-ammonia based detergent.
- Do not spray water or other cleaning liquids directly into the scanner window.
- If the contacts between the scanner and cradle become dirty, clean them with either a pencil eraser or a cotton swab dampened with alcohol.
- If a significant decrease in battery life is noticed and does not correspond to increased usage, consider replacing the battery.

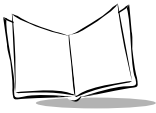

Troubleshooting

Refer to [Appendix C, Messages and Error Codes](#) for additional troubleshooting information.

Table 4-1. Troubleshooting Table

Problem	Possible Causes	Possible Solutions
Scanner won't power up.	Battery not charged.	Charge or replace the battery in the scanner
	Battery not installed properly.	Ensure the battery is installed properly. See <i>Changing the Battery</i> on page 2-7.
LED on base is always on.	Base is locked up	Cycle power (power off then on) to the base.
Nothing happens when you follow the operating instructions, or the scanner displays erratic behavior (laser does not come on, scanner emits frequent beeps).	No power to the scanner.	Check the system power. Ensure the power supply is connected, if your configuration requires a power supply.
	Interface/power cables are loose.	Check for loose cable connections at the cradle, AC power supply, or host device.
No laser beam when trigger is pressed.	Failed to download firmware.	Reset the scanner (remove and reinsert the battery, see <i>Changing the Battery</i> on page 2-7) and try scanning again.
	Scanner is locked up.	Reset the scanner (remove and reinsert the battery, see <i>Changing the Battery</i> on page 2-7) and try scanning again.
Laser comes on but the symbol does not decode.	Scanner is not programmed for the correct bar code type.	Ensure the scanner is programmed to read the type of barcode you are scanning.
	Bar code symbol is unreadable.	Check the symbol to ensure it is not defaced. Try scanning test symbols of the same bar code type.
	Distance between scanner and bar code is incorrect.	Move the scanner closer to or further away from the bar code.
Symbol decodes but data is not transmitted to the host.	Scanner is not programmed for the correct host type.	Scan the appropriate host type bar code.

Table 4-1. Troubleshooting Table (Continued)

Problem	Possible Causes	Possible Solutions
Scanned data is incorrectly displayed on the host.	Scanner is not programmed to work with the host.	Ensure the proper host type is selected. Check the scanner host type parameters or editing options: <ul style="list-style-type: none"> • For RS-232, ensure the scanner's communication parameters match the host's settings.
The scanner emits error beeps after decoding a bar code.	Cradle is not powered up or cable connections are not secure.	Check that the cradle is powered up and that its cable connections are secure. See <i>Setting Up the Cradle</i> on page 2-4.
	Scanner is too far from the base for proper transmission.	Move closer to the base and retransmit.
	Previously scanned data not transmitted to host.	Ensure you are within the proper RF transmission range.
Received a communication error beep while using a Synapse cable.	The cables connected to the cradle were not connected in the correct sequence.	Before power is applied to the cradle, the Synapse cable must be connected to the cradle <u>AND</u> the flying power lead plugged in. See <i>Using A Synapse Cable with the cradle</i> on page 2-9 for more information

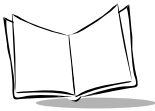

Table 4-1. Troubleshooting Table (Continued)

Problem	Possible Causes	Possible Solutions					
<p>The scanner does not scan the programming bar codes in this guide.</p>	<p>Bar code symbol is unreadable.</p>	<p>Check the symbol to ensure it is not defaced. Try scanning test symbols of the same bar code type.</p>					
	<p>Distance between scanner and bar code is incorrect.</p>	<p>Move the scanner closer to or further away from the bar code.</p>					
	<p>Scanner is not in scan mode.</p>	<p>For MCL-Designer generated applications, put the scanner into “Scan Parameter” mode in the system menu (see Scan Parameters on page 3-14).</p> <p>For the default application running on a previous version of the following firmware:</p> <table border="1" data-bbox="651 654 1119 792"> <tbody> <tr> <td data-bbox="651 654 783 722">P460/P360</td> <td data-bbox="783 654 877 722">1 MB</td> <td data-bbox="877 654 1119 722">Revision N or lower, such as M</td> </tr> <tr> <td data-bbox="651 722 783 792">P460/P360</td> <td data-bbox="783 722 877 792">4 MB or 8 MB</td> <td data-bbox="877 722 1119 792">Revision H or lower, such as G</td> </tr> </tbody> </table> <p>put the scanner into “Scan Parameter” mode in the system menu (see Scan Parameters on page 3-14). For instructions on how to check the scanner’s firmware version, see <i>Version</i> on page 3-16.</p>	P460/P360	1 MB	Revision N or lower, such as M	P460/P360	4 MB or 8 MB
P460/P360	1 MB	Revision N or lower, such as M					
P460/P360	4 MB or 8 MB	Revision H or lower, such as G					
<p>The PC cannot download an application to the scanner.</p>	<p>Incorrect cable connection.</p>	<p>Check to ensure you are using an RS-232 cable. The application cannot be downloaded to a scanner using a Synapse cable.</p>					
	<p>No power to the scanner.</p>	<p>Check to ensure the power supply is connected to the base.</p> <p>If the problem continues, cycle power to the base (power off then on).</p>					

Table 4-1. Troubleshooting Table (Continued)

Problem	Possible Causes	Possible Solutions
The Scanner will not load my ADF rule.	The scanner is running an MCL-Designer generated application.	Software download or scanning a bar code sheet while the scanner is running an MCL-Designer generated application <ul style="list-style-type: none"> • Erase the MCL-Designer application from the scanner's memory by scanning the "Reset Default Application" bar code on page 3-17. • The default application is now reinstalled and an ADF rule can be loaded.

Note: *If after performing these checks the symbol still does not scan, contact your distributor or call the Symbol Support Center. See [Symbol Support Center](#) on page [page xi](#) for the telephone number.*

Optional Accessories

Optional accessories include various stands and holders, which are supplied at extra cost.

One such optional accessory is the IntelliStand. When the scanner is inserted in the IntelliStand, it enables hands-free presentation scanning. It permits the Phaser to scan continuously and automatically read a bar code when one is presented in front of the scanner without an operator pulling the trigger. The Phaser must be operating from a cable with an external power supply to work with the IntelliStand, as it cannot work with battery power under these conditions. For more information about the IntelliStand, refer to the *IntelliStand Quick Reference Guide*, p/n 70-11567-xx.

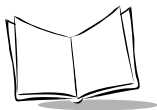

Technical Specifications

Table 4-2. Technical Specifications for P460/P360 1D Scanner

Item	Description
Decode Capability	UPC/EAN, Bookland EAN, Code 11, Code 39, Code 39 Full ASCII, Trioptic Code 39, Code 93, Codabar, Interleaved 2 of 5, Code 128, EAN 128, Discrete 2 of 5, MSI Plessey, and Coupon Code with auto-discriminate between all of the above code types except for Code 39 and Code 39 Full ASCII.
Scanner Beeper Operation	User-selectable: Enabled, Disabled.
Scan Repetition Rate	35 (± 5) scans/sec (bidirectional)
Roll (Skew) Tolerance	± 30° from normal
Pitch	± 65° from normal
Yaw	± 60° from normal
Decode Depth of Field	See <i>P460/P360 1D Scanner Decode Zone</i> on page 3-25.
Print Contrast Minimum	20% absolute dark/light differential, measured at the wavelength of the laser diode.
Ambient Light Immunity	
Artificial Lighting	450 ft. candles 4844 lux
Sunlight	10,000 ft. candles 107,644 lux
Operating Temperature	P460: 32° to 104°F 0° to 40°C P360: -4° to 122°F -20° to 50°C
Storage Temperature	-40° to 158°F -40° to 70°C
Humidity	5% to 95% (non-condensing)
Durability (Scanner)	P460: 5-ft. (1.5 m) P360: 6-ft. (1.8 m) Drops to concrete over entire temperature range
Sealing	P360: All components sealed to IP 54 specification against wind blown dust and rain
Dimensions	
Height	7.0 in. (17.8 cm)
Width	9.2 in. (13.5 cm)
Depth	3.5 in. (9.8 cm)
Laser Classifications	CDRH Class II EN 60825 Class 2 IEC 825 Class 2

Pin-outs

Cradle

The following table shows the pin-outs for both COM1 and COM2 on the cradle.

Table 4-3. Cradle Pin-outs

Pin	Cradle
1	BREQ
2	VCC (out of cradle)
3	Ground
4	Synapse Data
5	Synapse Clock
6	RXD (into cradle)
7	TXD (out of cradle)
8	BACK
9	CTS
10	RTS

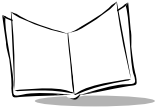

Scanner

The following table shows the pin-outs for the scanner.

Table 4-4. Scanner Pin-outs

Pin	Scanner						
1	Not Used						
2	Power (+9V) ¹						
3	GND						
4	Synapse Data						
5	Synapse Clock						
6	RXD (into scanner)						
7	TXD (out of scanner)						
8	Enable Charging ²						
9	CTS						
10	RTS						
1.							
<table border="1"><thead><tr><th colspan="2">Battery Charging:</th></tr><tr><th>No</th><th>Yes</th></tr></thead><tbody><tr><td>250mA</td><td>1A</td></tr></tbody></table>		Battery Charging:		No	Yes	250mA	1A
Battery Charging:							
No	Yes						
250mA	1A						
Requires +9V @:							
2. If Pin 8 is connected to Pin 2 the scanner battery charges; make sure you use a +9V @ 1 Amp power supply. If Pin 8 is not connected to Pin 2, the scanner operates but the scanner battery does not charge.							

Beeper Indications

Table 4-5. Beeper Indications

Beeper Sequence	Indication
Standard Use	
Short high tone	A bar code symbol was decoded (if decode beeper is enabled).
4 Beeps - long low tone	A transmission error has been detected in a scanned symbol. The data is ignored. This occurs if a unit is not properly configured. Check option settings.
5 Beeps - low tone	Convert or format error.
Hi/hi/hi/lo tone	RS-232 receive error.
4 Beeps - short hi	Battery requires recharging.
Short low/Short high tone	The Scanner detected external power supplied to it by the cradle or a cable.
Short high/Short low tone	External power has been removed from the scanner.
Parameter Menu Scanning	
Short high tone	Correct entry scanned or correct menu sequence performed.
Long low/Long high tone	Input error, incorrect bar code or "Cancel" scanned, wrong entry, incorrect bar code programming sequence; remain in program mode.
Hi/lo tone	Keyboard parameter selected. Enter value using bar code keypad.
Hi/lo/hi/lo tone	Successful program exit with change in the parameter setting.

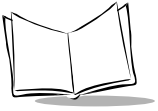

P460/P360 Memory Scanners Product Reference Guide

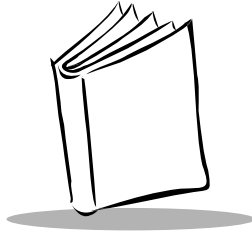

Chapter 5

Parameter Menus

Introduction

This chapter has the optional parameter bar codes necessary to program the Phaser memory scanner.

Operational Parameters

The Phaser memory scanner is shipped with the settings shown in [Table 5-1](#). These default values are stored in non-volatile memory and are preserved even when the scanner is powered down. You can change these default values by scanning the appropriate bar codes included in this manual. These new values replace the standard default values in memory. The default parameter values can be recalled by scanning the bar code in the section *Set Default Parameter* on page 5-7.

The scanner automatically detects which cable it is attached to, either an RS-232 or a Synapse cable. If it is attached to an RS-232 cable and has either an ICL, Nixdorf, or Fujitsu host interface, then scan the appropriate bar code from page [5-11](#) after power up. Any other host interface works with the default setting.

If it is attached to a Synapse cable, plug everything together as described on page [2-8](#) and then follow the directions that come with the Synapse cable for setting up the host interface.

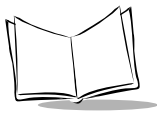

The following table lists the defaults for all parameters. If you wish to change any option, scan the appropriate bar code(s).

Table 5-1. Default Table

Parameter	1D P460/P360 Defaults	Page #
Set Default Parameter	All Defaults	5-7
Communication Protocol		
Scan & Transmit Application	RS-232/Synapse	5-8
Batch/Inventory Application	RS-232/Synapse	5-9
RS-232 Host Type	Standard	5-10
Sleep Time	10 seconds	5-13
Date Separator	Forward Slash (/)	5-14
Hour Type	12 Hour	5-15
Decimal Separator	Decimal Point (.)	5-16
Date Format	MM/DD/YYYY	5-17
Key Click	Enable	5-18
Laser On Time	3.0 seconds	5-19
Host Override	Disable	5-20
Beeper Options		
Beeper Tone	High Frequency	5-21
Beeper Volume	High	5-22
Power Detect Beep	Enable	5-23
Beep After Good Decode	Enable	5-24
Decode Options		
Transmit "No Read" Message	Disable	5-25

Table 5-1. Default Table (Continued)

Parameter	1D P460/P360 Defaults	Page #
UPC/EAN		
UPC-E	Enable	5-26
UPC-A	Enable	5-27
UPC-E1	Disable	5-28
EAN-8	Enable	5-29
EAN-13	Enable	5-30
Bookland EAN	Disable	5-31
Decode UPC/EAN Supplementals	Ignore	5-32
Decode UPC/EAN Supplemental Redundancy	7	5-33
Transmit UPC-A Check Digit	Enable	5-34
Transmit UPC-E Check Digit	Enable	5-34
Transmit UPC-E1 Check Digit	Enable	5-34
UPC-A Preamble	System Character	5-35
UPC-E Preamble	System Character	5-36
UPC-E1 Preamble	System Character	5-37
Convert UPC-E to A	Disable	5-38
Convert UPC-E1 to A	Disable	5-39
EAN-8 Zero Extend	Disable	5-40
UPC/EAN Coupon Code	Disable	5-41
Code 128		
Code 128	Enable	5-42

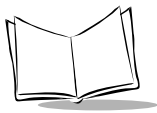

Table 5-1. Default Table (Continued)

Parameter	1D P460/P360 Defaults	Page #
UCC/EAN-128	Enable	5-43
ISBT-128	Enable	5-45
Code 39		
Code 39	Enable	5-46
Trioptic Code 39	Disable	5-47
Set Length(s) for Code 39	2 to 55	5-49
Code 39 Check Digit Verification	Disable	5-50
Transmit Code 39 Check Digit	Disable	5-51
Code 39 Full ASCII Conversion	Disable	5-52
Convert Code 39 to Code 32	Disable	5-53
Code 32 Prefix	Disable	5-54
Code 93		
Code 93	Disable	5-55
Set Length(s) for Code 93	4-55	5-56
Interleaved 2 of 5		
Interleaved 2 of 5	Enable	5-58
Set Length(s) for I 2 of 5	14	5-59
I 2 of 5 Check Digit Verification	Disable	5-61
Transmit I 2 of 5 Check Digit	Disable	5-62
Convert I 2 of 5 to EAN 13	Disable	5-63
Discrete 2 of 5		

Table 5-1. Default Table (Continued)

Parameter	1D P460/P360 Defaults	Page #
Discrete 2 of 5	Disable	5-64
Set Length(s) for D 2 of 5	12	5-65
Codabar		
Codabar	Disable	5-67
Set Lengths for Codabar	5-55	5-69
CLSI Editing	Disable	5-70
NOTIS Editing	Disable	5-71
MSI Plessey		
MSI Plessey	Disable	5-72
Set Length(s) for MSI Plessey	Any Length	5-74
MSI Plessey Check Digits	One	5-75
Transmit MSI Plessey Check Digit	Disable	5-76
MSI Plessey Check Digit Algorithm	Mod 10/Mod 10	5-77
Security Options		
Linear Code Type Security Levels	1	5-78
Bi-directional Redundancy	Disable	5-80
UPC/EAN Security Levels	0	5-81

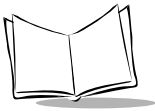

Table 5-1. Default Table (Continued)

Parameter	1D P460/P360 Defaults	Page #
RS-232		
RS-232 Host Type	Standard	5-10
Baud Rate	9600	5-84
Parity	None	5-85
Check Receive Errors	Disable	5-86
Hardware Handshaking	None	5-87
Software Handshaking	None	5-89
Host Serial Response Time-out	2 Sec.	5-92
RTS Line State (cable use only)	Low	5-92
Stop Bit Select	1	5-93
ASCII Format	8-Bit	5-93
Beep on <BEL>	Disable	5-94
Intercharacter Delay	0	5-94
MCL-Net		
MCL-Net Baud Rate	38400	5-95
MCL-Net Hex Addressing Mode	Disable	5-97
Scanner Address	001	5-98
MCL-Net Transmit Retries	3	5-98
MCL-Net Frame Timeout	500 ms	5-98

Set Default Parameter

Scanning this bar code returns all parameters to the values listed in [Table 5-1](#) (factory settings), but does not erase any programmed ADF rules.



SET ALL DEFAULTS

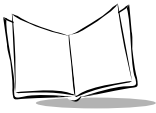

Communication Protocol

The bar codes below set the communication protocol used by the default applications.

- Scan & Transmit application for corded operation
- Batch/Inventory application for uncoded (Batch) operation.

The communication options are RS-232/Synapse or MCL-Net. If you select RS-232/Synapse, the scanner automatically identifies whether an RS-232 or Synapse interface is required. MCL-Net allows the scanner to communicate with a host running MCL-Link or MCL-Link Lite.

The communication protocols for the two default applications can be set independently of each other.

Note: *These communication protocol parameters are only for the Scan & Transmit and Batch/Inventory applications and will not work with applications created with MCL-Designer.*

Scan & Transmit Application

This communication protocol is used for the real time scanning and transmission of data to a host when a cable is attached.



***RS-232/SYNAPSE**
(Scan & Transmit application only)



MCL-NET
(Scan & Transmit application only)

Batch/Inventory Application

This communication protocol is used when you are ready to transmit your batch records (data collected when the scanner was used without a cable attached) to a host.



***RS-232/SYNAPSE**
(Batch/Inventory application only)



MCL-NET
(Batch/Inventory application only)

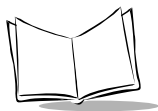

Host Type

RS-232 Host Types

Most RS-232 hosts work fine with the default settings, however, three RS-232 hosts are set up with their own parameter default settings. Selecting the ICL, Fujitsu or Nixdorf RS-232 host interface sets the defaults listed below. These defaults take precedence over Standard RS-232 defaults. So, if you select the Fujitsu RS-232 first, and then select the Standard RS-232 defaults, the Fujitsu defaults still take precedence. To return to the factory set defaults, scan the **SET ALL DEFAULTS** bar code on page [5-7](#).

Table 5-2. Terminal Specific RS-232

Parameter	Standard	ICL	FUJITSU	NIXDORF Mode A/ Mode B
Transmit Code ID	No	Yes	Yes	Yes
Data Transmission Format	Data as is	Data/Suffix	Data/Suffix	Data/Suffix
Suffix	CR/LF	CR	CR	CR
Baud Rate	9600	9600	9600	9600
Parity	None	Even	None	Odd
Hardware Handshaking	None	RTS/CTS Option 3	None	RTS/CTS Option 3
Software Handshaking	None	None	None	None
Serial Response Time-out	2 Sec.	9.9 Sec.	2 Sec.	9.9 Sec.
Stop Bit Select	One	One	One	One
ASCII Format	8-Bit	8-Bit	8-Bit	8-Bit
Beep On <BEL>	Disabled	Disabled	Disabled	Disabled
RTS Line State	Low	High	Low	*Low = No data to send

*In the Nixdorf Mode B, if CTS is Low, transmission of scan data is disabled. When CTS is High, bar code data is transmitted to the host.

**If Nixdorf Mode B is scanned without the scanner connected to the proper host, it may appear unable to scan. If this happens, scan a different RS-232 host type within 5 seconds of cycling power to the scanner.

Scan the appropriate bar code below to select an RS-232 Host Interface.



***STANDARD RS-232**



ICL RS-232



NIXDORF RS-232 Mode A



NIXDORF RS-232 Mode B



FUJITSU RS-232



OPOS

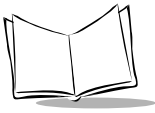

Code ID Characters for RS-232 Host Types

Selecting the ICL, Fujitsu, or Nixdorf RS-232 host interface enables the transmission of Code ID Characters as listed below. These Code ID Characters are not programmable and are separate from the Transmit Code ID feature. The Transmit Code ID feature should not be enabled for these hosts.

Table 5-3. Terminal Specific Code ID Characters

	ICL	FUJITSU	NIXDORF
UPC-A	"A"	"A"	"A"
UPC-E	"E"	"E"	"C0"
EAN-8	"FF"	"FF"	"B"
EAN-13	"F"	"F"	"A"
Code 39	"C" <len>	None	"M"
Codabar	"N" <len>	None	"N"
Code 128	"L" <len>	None	"K"
I 2 of 5	"I" <len>	None	"I"
Code 93	None	None	"L"
D 2 of 5	"H" <len>	None	"H"
UCC/EAN 128	"L" <len>	None	"P"
MSI/Plessey	None	None	"O"
Bookland EAN	"F"	"F"	"A"
Unlisted Code Types	None	None	None

Sleep Time

Scan the bar code below to select how long the scanner will “stay awake” (not power down) in seconds after a trigger pull or a key press. First scan this bar code, then enter a range from 05 to 32, using the *Numeric Bar Codes* on page 5-99. It can stay awake from 5 seconds to 32 seconds. The default time is set at 10 seconds.

Note: *Allowing the scanner to stay awake longer than originally programmed may effect the battery life time for that session before needing a charge.*



SLEEP TIME (RANGE OF 5 TO 32 SECONDS)

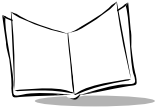

Date Separator

Scan the appropriate bar code below to select which separator to use when displaying the date. Choose FORWARD SLASH, DASH, COLON or NONE.



***FORWARD SLASH (/)**



DASH (-)



COLON (:)



NONE

Hour Type

Scan the appropriate bar code below to select how to display the hour and transmit it to the host device. Choose 12 HOUR (6:00 pm) or 24 HOUR (18:00).



24 HOUR



***12 HOUR**

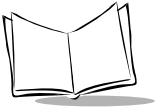

Decimal Separator

Scan the appropriate bar code below to select what separator to display when you hit the decimal point key on the keypad. Choose DECIMAL POINT (.) or COMMA (,).



***DECIMAL POINT (.)**



COMMA (,)

Date Format

Scan the appropriate bar code below to select how to format the date when it is displayed and transmitted to the host device. Choose MM/DD/YYYY or DD/MM/YYYY.



***MM/DD/YYYY**



DD/MM/YYYY

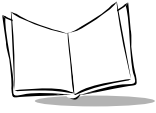

Key Click

Scan the appropriate bar code below to select whether the keypad click is enabled or not. Choose ENABLE or DISABLE.



***ENABLE**



DISABLE

Laser On Time

This parameter sets the maximum time decode processing continues during a scan attempt. It is programmable in 0.1 second increments from 0.5 to 9.9 seconds.

Scan the bar code below to set a Laser On Time. Next scan two numeric bar codes beginning on page [5-99](#) that correspond to the desired time. Time less than 1.0 second must have a leading zero. For example, to set a Time On of 0.5 seconds, scan the bar code below, then scan the “0” and “5” bar codes. If you make an error, or wish to change your selection, scan *CANCEL* on page 5-101. The default time is set at 3 seconds.



LASER ON TIME

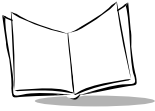

Host Override

This parameter allows the scanner to communicate when it is not on any auxiliary power supply. When this parameter is enabled, the scanner does not wait for cradle or cable connection, but just begins transmitting.

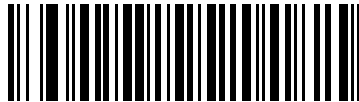

ENABLE



***DISABLE**

Beeper Options

Beeper Tone

Scan the appropriate bar code below to select a decode beep frequency (tone). Choose LOW FREQUENCY, MEDIUM FREQUENCY, or HIGH FREQUENCY.

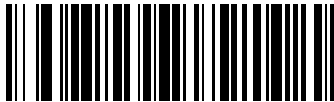

LOW FREQUENCY

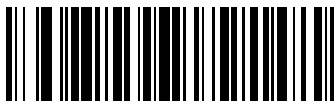

MEDIUM FREQUENCY



***HIGH FREQUENCY**

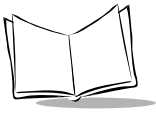

Beeper Volume

Scan the appropriate bar code below to select a beeper volume. Choose LOW VOLUME, MEDIUM VOLUME, or HIGH VOLUME.



LOW VOLUME



MEDIUM VOLUME



***HIGH VOLUME**

Power Detect Beep

Scan the appropriate barcode below to enable or disable the Power Detection Beep.



POWER DETECT BEEP DISABLED



***POWER DETECT BEEP ENABLED**

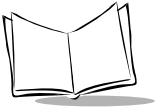

Beep After Good Decode

Scan the appropriate bar code below to select whether or not the scanner beeps after a good decode. If DO NOT BEEP is selected, the beeper still operates during parameter menu scanning and indicates error conditions.



***BEEP AFTER GOOD DECODE**



DO NOT BEEP AFTER GOOD DECODE

Decode Options

Transmit “No Read” Message

Scan the appropriate bar code below to select whether or not a “No Read” message is transmitted. When enabled, if a symbol does not decode, “NR” is transmitted. When disabled, if a symbol does not read, nothing is sent to the host.



ENABLE NO READ



***DISABLE NO READ**

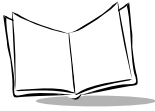

Enable/Disable UPC-E

Scan the appropriate bar code below to enable or disable UPC-E.

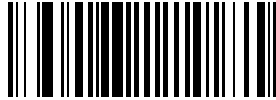

***ENABLE UPC-E**

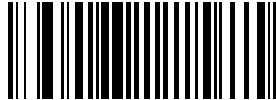

DISABLE UPC-E

Enable/Disable UPC-A

Scan the appropriate bar code below to enable or disable UPC-A.

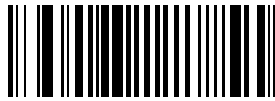

***ENABLE UPC-A**

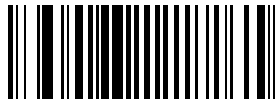

DISABLE UPC-A

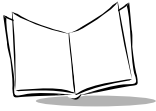

Enable/Disable UPC-E1

Scan the appropriate bar code below to enable or disable UPC-E1.



ENABLE UPC-E1



***DISABLE UPC-E1**

Enable/Disable EAN-8

Scan the appropriate bar code below to enable or disable EAN-8 or EAN-13.

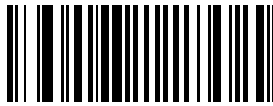

***ENABLE EAN-8**

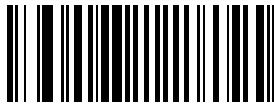

DISABLE EAN-8

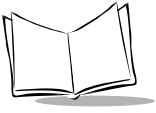

Enable/Disable EAN-13

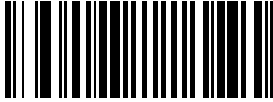

***ENABLE EAN-13**

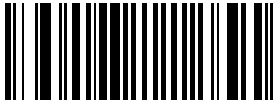

DISABLE EAN-13

Enable/Disable Bookland EAN

Scan the appropriate bar code below to enable or disable Bookland EAN.



ENABLE BOOKLAND EAN



***DISABLE BOOKLAND EAN**

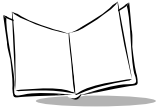

Decode UPC/EAN Supplementals

Supplementals are characters (either 2 or 5) that are added on according to specific code format conventions (e.g., UPC A+2, UPC E+2, EAN 8+2). Three options are available.

- If **Decode UPC/EAN with supplementals** is selected, UPC/EAN symbols without supplemental characters are not decoded.
- If **Ignore UPC/EAN with supplementals** is selected, UPC/EAN symbols with supplemental characters are decoded and the supplemental characters are ignored.
- If **Autodiscriminate UPC/EAN supplementals** is selected, UPC/EAN symbols, either with or without supplementals, are decoded. If selected, choose an appropriate [Decode UPC/EAN Supplemental Redundancy](#) value from the next page.

Note: *To minimize the risk of invalid data transmission, select whether to read or ignore supplemental characters.*

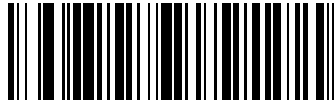

DECODE UPC/EAN WITH SUPPLEMENTALS

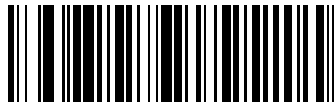

***IGNORE UPC/EAN WITH SUPPLEMENTALS**



AUTODISCRIMINATE UPC/EAN SUPPLEMENTALS

Decode UPC/EAN Supplemental Redundancy

With Autodiscriminate UPC/EAN Supplementals selected, this option adjusts the number of times a symbol without supplementals is decoded before transmission. The range is from two to 20 times. Five or above is recommended when decoding a mix of UPC/EAN symbols with and without supplementals, and the autodiscriminate option is selected. The default is set to 7 times.

Scan the bar code below to select a decode redundancy value. Next scan two numeric bar codes beginning on page 5-99. Single digit numbers must have a leading zero. If you make an error, or wish to change your selection, scan *CANCEL* on page 5-101.

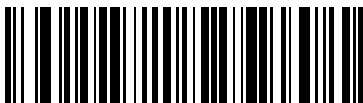

**DECODE UPC/EAN
SUPPLEMENTAL REDUNDANCY**

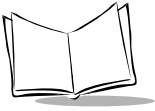

Transmit UPC-A/UPC-E/UPC-E1 Check Digit

Scan the appropriate bar code below to transmit the symbol with or without the UPC-A, UPC-E, or UPC-E1 check digit.



***TRANSMIT UPC-A CHECK DIGIT**

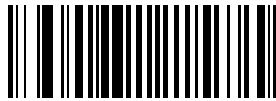

DO NOT TRANSMIT UPC-A CHECK DIGIT

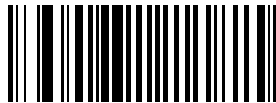

***TRANSMIT UPC-E CHECK DIGIT**

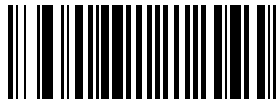

DO NOT TRANSMIT UPC-E CHECK DIGIT



***TRANSMIT UPC-E1 CHECK DIGIT**



DO NOT TRANSMIT UPC-E1 CHECK DIGIT

UPC-A Preamble

Three options are given for lead-in characters for UPC-A symbols transmitted to the host device: transmit system character only, transmit system character and country code ("0" for USA), and no preamble transmitted. The lead-in characters are considered part of the symbol.

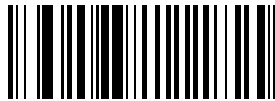

NO PREAMBLE

(<DATA>)

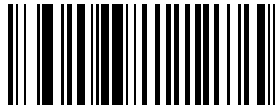

***SYSTEM CHARACTER
(<SYSTEM CHARACTER> <DATA>)**



**SYSTEM CHARACTER & COUNTRY CODE
(< COUNTRY CODE> <SYSTEM CHARACTER> <DATA>)**

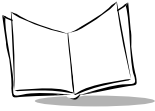

UPC-E Preamble

Three options are given for lead-in characters for UPC-E symbols transmitted to the host device: Transmit system character only, transmit system character and country code ("0" for USA), and no preamble transmitted. The lead-in characters are considered part of the symbol.

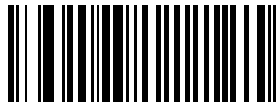

NO PREAMBLE
(<DATA>)

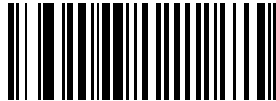

***SYSTEM CHARACTER**
(<SYSTEM CHARACTER> <DATA>)



SYSTEM CHARACTER & COUNTRY CODE
(< COUNTRY CODE> <SYSTEM CHARACTER> <DATA>)

UPC-E1 Preamble

Three options are given for lead-in characters for UPC-E1 symbols transmitted to the host device: Transmit system character only, transmit system character and country code ("0" for USA), and no preamble transmitted. The lead-in characters are considered part of the symbol.



NO PREAMBLE
(<DATA>)



***SYSTEM CHARACTER**
(<SYSTEM CHARACTER> <DATA>)



SYSTEM CHARACTER & COUNTRY CODE
(< COUNTRY CODE> <SYSTEM CHARACTER> <DATA>)

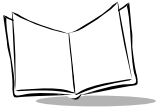

Convert UPC-E to UPC-A

This parameter converts UPC-E (zero suppressed) decoded data to UPC-A format before transmission. After conversion, data follows UPC-A format and is affected by UPC-A programming selections (e.g., Preamble, Check Digit).

Scanning **DO NOT CONVERT UPC-E TO UPC-A** allows you to transmit UPC-E (zero suppressed) decoded data.

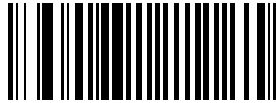

**CONVERT UPC-E TO UPC-A
(ENABLE)**



***DO NOT CONVERT UPC-E TO UPC-A
(DISABLE)**

Convert UPC-E1 to UPC-A

This parameter converts UPC-E1 decoded data to UPC-A format before transmission. After conversion, data follows UPC-A format and is affected by UPC-A programming selections (e.g., Preamble, Check Digit).

Scanning **DO NOT CONVERT UPC-E1 TO UPC-A** allows you to transmit UPC-E1 decoded data.



**CONVERT UPC-E1 TO UPC-A
(ENABLE)**



***DO NOT CONVERT UPC-E1 TO UPC-A
(DISABLE)**

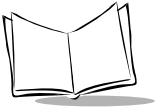

EAN Zero Extend

If this parameter is enabled, five leading zeros are added to decoded EAN-8 symbols to make them compatible in format to EAN-13 symbols.

Disabling this parameter returns EAN-8 symbols to their normal format.



ENABLE EAN ZERO EXTEND

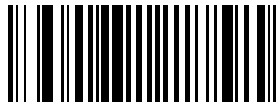

***DISABLE EAN ZERO EXTEND**

UPC/EAN Coupon Code

When this parameter is enabled, the Phaser decodes UPC-A, UPC-A with 2 supplemental characters, UPC-A with 5 supplemental characters, and UPC-A/EAN128 bar codes. *AUTODISCRIMINATE UPC/EAN SUPPLEMENTALS* on page 5-32 must be enabled.



ENABLE UPC/EAN COUPON CODE



***DISABLE UPC/EAN COUPON CODE**

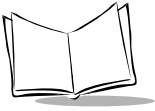

Enable/Disable Code 128

Scan the appropriate bar code below to enable or disable Code 128.



***ENABLE CODE 128**

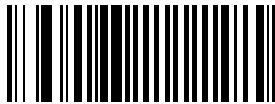

DISABLE CODE 128

Note: *The “j” character and the NULL character cannot be embedded in the barcode to be scanned when using Code 128.*

Enable/Disable UCC/EAN-128

Scan the appropriate bar code below to enable or disable UCC/EAN-128. (See [Appendix A, Bar Code Information](#) for details on UCC/EAN-128.)

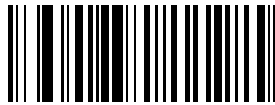

***ENABLE UCC/EAN-128**

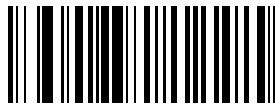

DISABLE UCC/EAN-128

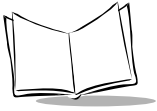

Lengths for Code 128

No length setting is required for Code 128. The default setting is Any Length.

Enable/Disable ISBT 128

To enable or disable ISBT 128, scan the appropriate bar code below.



***Enable ISBT 128**



Disable ISBT 128

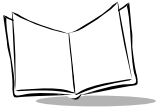

Enable/Disable Code 39

Scan the appropriate bar code below to enable or disable Code 39.



***ENABLE CODE 39**

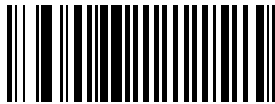

DISABLE CODE 39

Enable/Disable Trioptic Code 39

Trioptic Code 39 symbols always contain six characters. Trioptic Code 39 and Code 39 Full ASCII cannot be enabled simultaneously. If you get an error beep when enabling Trioptic Code 39, disable Code 39 Full ASCII and try again. To enable or disable Trioptic Code 39, scan the appropriate bar code below.



ENABLE TRIOPTIC CODE 39



***DISABLE TRIOPTIC CODE 39**

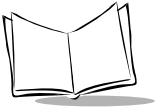

Set Lengths for Code 39

Lengths for Code 39 may be set for any length, one or two discrete lengths, or lengths within a specific range. The length of a code refers to the number of characters (i.e., human readable characters), including check digit(s) the code contains. If Code 39 Full ASCII is enabled, **Length Within a Range** or **Any Length** are the preferred options. The default is set to a length of 2 to 55 characters.

One Discrete Length - This option allows you to decode only those codes containing a selected length. For example, if you select **Code 39 One Discrete Length**, then scan **1, 4**, only Code 39 symbols containing 14 characters are decoded. Numeric bar codes begin on page [5-99](#). If you make an error, or wish to change your selection, scan **CANCEL** on page 5-101.



CODE 39 - ONE DISCRETE LENGTH

Two Discrete Lengths - This option allows you to decode only those codes containing two selected lengths. For example, if you select **Code 39 Two Discrete Lengths**, then scan **0, 2, 1, 4**, only Code 39 symbols containing 2 or 14 characters are decoded. Numeric bar codes begin on page [5-99](#). If you make an error, or wish to change your selection, scan **CANCEL** on page 5-101.

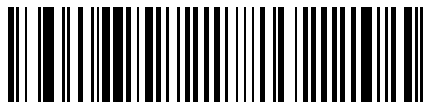

CODE 39 - TWO DISCRETE LENGTHS

Set Lengths for Code 39 (Continued)

Length Within Range - This option allows you to decode a code type within a specified range. For example to decode Code 39 symbols containing between 4 and 12 characters, first scan **Code 39 Length Within Range**. Then scan **0, 4, 1** and **2** (single digit numbers must always be preceded by a leading zero). Numeric bar codes begin on page [5-99](#). If you make an error, or wish to change your selection, scan *CANCEL* on page 5-101.



CODE 39 - LENGTH WITHIN RANGE

Any Length - Scanning this option allows you to decode Code 39 symbols containing any number of characters.



CODE 39 - ANY LENGTH

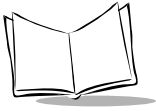

Code 39 Check Digit Verification

When enabled, this parameter checks the integrity of a Code 39 symbol to ensure it complies with specified algorithms.

Only those Code 39 symbols which include a modulo 43 check digit are decoded when this parameter is enabled.

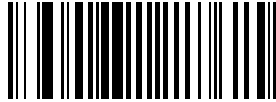

ENABLE CODE 39 CHECK DIGIT

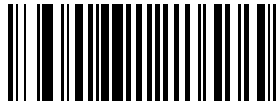

***DISABLE CODE 39 CHECK DIGIT**

Transmit Code 39 Check Digit

Scan the appropriate bar code below to transmit the data with or without the check digit.



**TRANSMIT CODE 39 CHECK DIGIT
(ENABLE)**



***DO NOT TRANSMIT CODE 39 CHECK DIGIT
(DISABLE)**

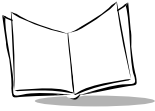

Enable/Disable Code 39 Full ASCII

Scan the appropriate bar code below to enable or disable Code 39 Full ASCII.

When enabled, the ASCII character set assigns a code to letters, punctuation marks, numerals, and most control keystrokes on the keyboard.

The first 32 codes are non-printable and are assigned to keyboard control characters such as BACKSPACE and RETURN. The other 96 are called printable codes because all but SPACE and DELETE produce visible characters.

Code 39 Full ASCII interprets the bar code special character (\$ + % /) preceding a Code 39 character and assigns an ASCII character value to the pair. For example, when Code 39 Full ASCII is enabled and a **+B** is scanned, it is interpreted as **b**, **%J** as **?**, and **\$H** emulates the keystroke **BACKSPACE**. Scanning **ABC\$M** will output the keystroke equivalent of **ABC ENTER**. Refer to the ASCII table in *Appendix A*.

Code 39 Full ASCII and Trioptic Code 39 cannot be enabled simultaneously. If you get an error beep when enabling Code 39 Full ASCII, disable Trioptic Code 39 and try again.

The scanner does not autodiscriminate between Code 39 and Code 39 Full ASCII.



ENABLE CODE 39 FULL ASCII



***DISABLE CODE 39 FULL ASCII**

Note: *The “j” character and the NULL character cannot be embedded in the barcode to be scanned when using Code 39 Full ASCII.*

Convert Code 39 to Code 32

Scan the appropriate bar code below to enable or disable converting Code 39 to Code 32.

Note: Code 39 must be enabled in order for this parameter to function.



**CONVERT CODE 39 TO CODE 32
(ENABLE)**



***DO NOT CONVERT CODE 39 TO CODE 32
(DISABLE)**

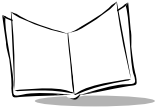

Code 32 Prefix

Scan the appropriate bar code below to enable or disable the prefix character “A” to all Code 32 bar codes.

Note: *Convert Code 39 to Code 32 must be enabled for this parameter to function.*



ENABLE CODE 32 PREFIX



***DISABLE CODE 32 PREFIX**

Enable/Disable Code 93

Scan the appropriate bar code below to enable or disable Code 93.



ENABLE CODE 93



***DISABLE CODE 93**

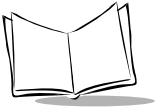

Set Lengths for Code 93

Lengths for Code 93 may be set for any length, one or two discrete lengths, or lengths within a specific range. The length of a code refers to the number of characters (i.e., human readable characters), including check digit(s) the code contains. The default is set to a length of 4 to 55 characters.

One Discrete Length - This option allows you to decode only those codes containing a selected length. For example, if you select **Code 93 One Discrete Length**, then scan **1, 4**, only Code 93 symbols containing 14 characters are decoded. Numeric bar codes begin on page [5-99](#). If you make an error, or wish to change your selection, scan **CANCEL** on page 5-101.



CODE 93 - ONE DISCRETE LENGTH

Two Discrete Lengths - This option allows you to decode only those codes containing two selected lengths. For example, if you select **Code 93 Two Discrete Lengths**, then scan **0, 2, 1, 4**, only Code 93 symbols containing 2 or 14 characters are decoded. Numeric bar codes begin on page [5-99](#). If you make an error, or wish to change your selection, scan **CANCEL** on page 5-101.



CODE 93 - TWO DISCRETE LENGTHS

Set Lengths for Code 93 (Continued)

Length Within Range - This option allows you to decode a code type within a specified range. For example to decode Code 93 symbols containing between 4 and 12 characters, first scan **Code 93 Length Within Range**. Then scan **0, 4, 1** and **2** (single digit numbers must always be preceded by a leading zero). Numeric bar codes begin on page [5-99](#). If you make an error, or wish to change your selection, scan *CANCEL* on page 5-101.



CODE 93 - LENGTH WITHIN RANGE

Any Length - Scanning this option allows you to decode Code 93 symbols containing any number of characters.



CODE 93 - ANY LENGTH

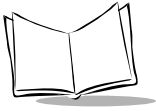

Enable/Disable Interleaved 2 of 5

Scan the appropriate bar code below to enable or disable Interleaved 2 of 5.



***ENABLE INTERLEAVED 2 OF 5**

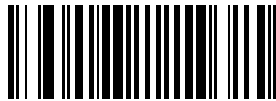

DISABLE INTERLEAVED 2 OF 5

Set Lengths for Interleaved 2 of 5

Lengths for I 2 of 5 may be set for any length, one or two discrete lengths, or lengths within a specific range. The length of a code refers to the number of characters (i.e., human readable characters) the code contains and includes check digits. The default is set to a length of 14 characters.

One Discrete Length - This option allows you to decode only those codes containing a selected length. For example, if you select **I 2 of 5 One Discrete Length**, then scan **1, 4**, the only I 2 of 5 symbols decoded are those containing 14 characters. Numeric bar codes begin on page [5-99](#). If you make an error, or wish to change your selection, scan **CANCEL** on page 5-101.



I 2 of 5 - ONE DISCRETE LENGTH

Two Discrete Lengths - This option allows you to decode only those codes containing two selected lengths. For example, if you select **I 2 of 5 Two Discrete Lengths**, then scan **0, 2, 1, 4**, the only I 2 of 5 symbols decoded are those containing 2 or 14 characters. Numeric bar codes begin on page [5-99](#). If you make an error, or wish to change your selection, scan **CANCEL** on page 5-101.



I 2 of 5 - TWO DISCRETE LENGTHS

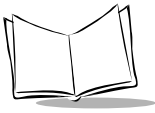

Set Lengths for Interleaved 2 of 5 (Continued)

Length Within Range - This option allows you to decode a code type within a specified range. For example to decode I 2 of 5 symbols containing between 4 and 12 characters, first scan **I 2 of 5 Length Within Range**. Then scan **0, 4, 1** and **2** (single digit numbers must always be preceded by a leading zero). Numeric bar codes begin on page [5-99](#). If you make an error, or wish to change your selection, scan *CANCEL* on page 5-101.



I 2 of 5 - LENGTH WITHIN RANGE

Any Length - Scanning this option allows you to decode I 2 of 5 symbols containing any number of characters.

Note: *Selecting this option may lead to mis-decodes for I 2 of 5 codes.*



I 2 of 5 - ANY LENGTH

I 2 of 5 Check Digit Verification

When enabled, this parameter checks the integrity of an I 2 of 5 symbol to ensure it complies with a specified algorithm, either USS (Uniform Symbology Specification), or OPCC (Optical Product Code Council).



***DISABLE**



USS CHECK DIGIT



OPCC CHECK DIGIT

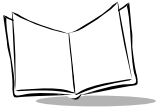

Transmit I 2 of 5 Check Digit

Scan the appropriate bar code below to transmit the data with or without the check digit.



**TRANSMIT I 2 of 5 CHECK DIGIT
(ENABLE)**



***DO NOT TRANSMIT I 2 of 5 CHECK DIGIT
(DISABLE)**

Convert I 2 of 5 to EAN-13

This parameter converts a 14 character I 2 of 5 code into EAN-13, and transmits to the host as EAN-13. In order to accomplish this, the I 2 of 5 code must be enabled, one length must be set to 14, and the code must have a leading zero and a valid EAN-13 check digit.



**CONVERT I 2 of 5 to EAN-13
(ENABLE)**



***DO NOT CONVERT I 2 of 5 to EAN-13
(DISABLE)**

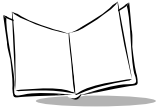

Enable/Disable Discrete 2 of 5

Scan the appropriate bar code below to enable or disable Discrete 2 of 5.



ENABLE DISCRETE 2 OF 5



***DISABLE DISCRETE 2 OF 5**

Set Lengths for Discrete 2 of 5

Lengths for D 2 of 5 may be set for any length, one or two discrete lengths, or lengths within a specific range. The length of a code refers to the number of characters (i.e., human readable characters) the code contains, and includes check digits. The default is set to a length of 12 characters.

One Discrete Length - This option allows you to decode only those codes containing a selected length. For example, if you select **D 2 of 5 One Discrete Length**, then scan **1, 4**, the only D 2 of 5 symbols decoded are those containing 14 characters. Numeric bar codes begin on page [5-99](#). If you make an error, or wish to change your selection, scan **CANCEL** on page 5-101.



D 2 of 5 - ONE DISCRETE LENGTH

Two Discrete Lengths - This option allows you to decode only those codes containing two selected lengths. For example, if you select **D 2 of 5 Two Discrete Lengths**, then scan **0, 2, 1, 4**, the only D 2 of 5 symbols decoded are those containing 2 or 14 characters. Numeric bar codes begin on page [5-99](#). If you make an error, or wish to change your selection, **CANCEL** on page 5-101.



D 2 of 5 - TWO DISCRETE LENGTHS

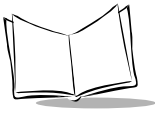

Set Lengths for Discrete 2 of 5 (Continued)

Length Within Range - This option allows you to decode a code type within a specified range. For example to decode D 2 of 5 symbols containing between 4 and 12 characters, first scan **D 2 of 5 Length Within Range**. Then scan **0, 4, 1** and **2** (single digit numbers must always be preceded by a leading zero). Numeric bar codes begin on page [5-99](#). If you make an error, or wish to change your selection, scan *CANCEL* on page 5-101.



D 2 of 5 - LENGTH WITHIN RANGE

Any Length - Scanning this option allows you to decode D 2 of 5 symbols containing any number of characters.

Note: *Selecting this option may lead to mis-decodes for D 2 of 5 codes.*



D 2 of 5 - ANY LENGTH

Enable/Disable Codabar

Scan the appropriate bar code below to enable or disable Codabar.



ENABLE CODABAR

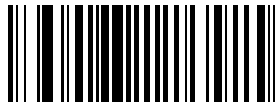

***DISABLE CODABAR**

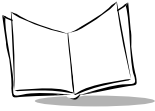

Set Lengths for Codabar

Lengths for Codabar may be set for any length, one or two discrete lengths, or lengths within a specific range. The length of a code refers to the number of characters (i.e., human readable characters) the code contains. It also includes any start or stop characters. The default is set to a length of 5 to 55 characters.

One Discrete Length - This option allows you to decode only those codes containing a selected length. For example, if you select **Codabar One Discrete Length**, then scan **1, 4**, the only Codabar symbols decoded are those containing 14 characters. Numeric bar codes begin on page [5-99](#). If you make an error, or wish to change your selection, scan **CANCEL** on page 5-101.



CODABAR - ONE DISCRETE LENGTH

Two Discrete Lengths - This option allows you to decode only those codes containing two selected lengths. For example, if you select **Codabar Two Discrete Lengths**, then scan **0, 2, 1, 4**, the only Codabar symbols decoded are those containing 2 or 14 characters. Numeric bar codes begin on page [5-99](#). If you make an error, or wish to change your selection, scan **CANCEL** on page 5-101.



CODABAR - TWO DISCRETE LENGTHS

Set Lengths for Codabar (Continued)

Length Within Range - This option allows you to decode a code type within a specified range. For example to decode Codabar symbols containing between 4 and 12 characters, first scan **Codabar Length Within Range**. Then scan **0, 4, 1** and **2** (single digit numbers must always be preceded by a leading zero). Numeric bar codes begin on page [5-99](#). If you make an error, or wish to change your selection, scan *CANCEL* on page 5-101.



CODABAR - LENGTH WITHIN RANGE

Any Length - Scanning this option allows you to decode Codabar symbols containing any number of characters.



CODABAR - ANY LENGTH

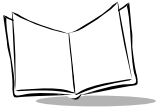

CLSI Editing

If enabled, this parameter strips the start and stop characters and inserts a space after the first, fifth, and tenth characters of a 14-character Codabar symbol.

Note: *Symbol length does not include start and stop characters.*

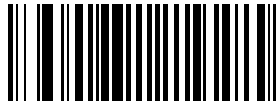

ENABLE CLSI EDITING

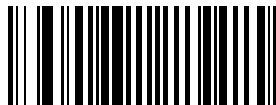

***DISABLE CLSI EDITING**

NOTIS Editing

If enabled, this parameter strips the start and stop characters from a decoded Codabar symbol.

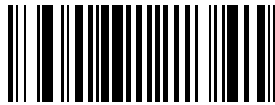

ENABLE NOTIS EDITING

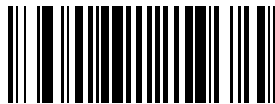

***DISABLE NOTIS EDITING**

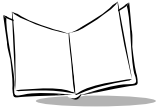

Enable/Disable MSI Plessey

Scan the appropriate bar code below to enable or disable MSI Plessey.



ENABLE MSI PLESSEY



***DISABLE MSI PLESSEY**

Set Lengths for MSI Plessey

Lengths for MSI Plessey may be set for any length, one or two discrete lengths, or lengths within a specific range. The length of a code refers to the number of characters (i.e., human readable characters) the code contains, and includes check digits.

One Discrete Length - This option allows you to decode only those codes containing a selected length. For example, if you select **MSI Plessey One Discrete Length**, then scan **1, 4**, the only MSI Plessey symbols decoded are those containing 14 characters. Numeric bar codes begin on page [5-99](#). If you make an error, or wish to change your selection, scan **CANCEL** on page 5-101.



MSI PLESSEY - ONE DISCRETE LENGTH

Two Discrete Lengths - This option allows you to decode only those codes containing two selected lengths. For example, if you select **MSI Plessey Two Discrete Lengths**, then scan **0, 2, 1, 4**, the only MSI Plessey symbols decoded are those containing 2 or 14 characters. Numeric bar codes begin on page [5-99](#). If you make an error, or wish to change your selection, scan **CANCEL** on page 5-101.



MSI PLESSEY - TWO DISCRETE LENGTHS

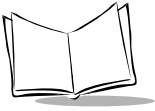

Set Lengths for MSI Plessey (Continued)

Length Within Range - This option allows you to decode a code type within a specified range. For example to decode MSI Plessey symbols containing between 4 and 12 characters, first scan **MSI Plessey Length Within Range**. Then scan **0, 4, 1** and **2** (single digit numbers must always be preceded by a leading zero). Numeric bar codes begin on page [5-99](#). If you make an error, or wish to change your selection, scan *CANCEL* on page 5-101.



MSI PLESSEY - LENGTH WITHIN RANGE

Any Length - Scanning this option allows you to decode MSI Plessey symbols containing any number of characters.

Note: *Selecting this option may lead to mis-decodes for MSI Plessey codes.*



***MSI PLESSEY - ANY LENGTH**

MSI Plessey Check Digits

These check digits at the end of the bar code verify the integrity of the data. At least one check digit is always required. Check digits are not automatically transmitted with the data.



***ONE MSI PLESSEY CHECK DIGIT**



TWO MSI PLESSEY CHECK DIGITS

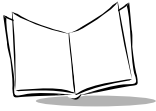

Transmit MSI Plessey Check Digit

Scan the appropriate bar code below to transmit the data with or without the check digit.



**TRANSMIT MSI PLESSEY CHECK DIGIT
(ENABLE)**



***DO NOT TRANSMIT MSI PLESSEY CHECK DIGIT
(DISABLE)**

MSI Plessey Check Digit Algorithm

When the two MSI Plessey check digits option is selected, an additional verification is required to ensure integrity. Either of the two following algorithms may be selected.



MOD 10/MOD 11



***MOD 10/MOD 10**

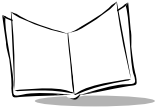

Security Options

Linear Code Type Security Levels

The Phaser offers four levels of decode security for linear code types (e.g., Code 39, Interleaved 2 of 5). Higher security levels are selected for decreasing levels of bar code quality. As security levels increase, the scanner's aggressiveness decreases.

Select the security level appropriate for your bar code quality.

Note: *Does not apply to Code 128.*

Linear Security Level 1

The following code types must be successfully read twice before being decoded

Code Type	Length
Codabar	All
MSI Plessey	4 or less
D 2 of 5	8 or less
I 2 of 5	8 or less



***LINEAR SECURITY LEVEL 1**

Linear Security Level 2

All code types must be successfully read twice before being decoded.

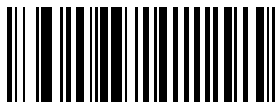

LINEAR SECURITY LEVEL 2

Linear Security Level 3

Code types other than the following must be successfully read twice before being decoded. The following codes must be read three times:

Code Type	Length
MSI Plessey	4 or less
D 2 of 5	8 or less
I 2 of 5	8 or less

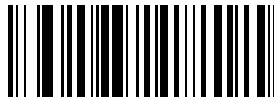

LINEAR SECURITY LEVEL 3

Linear Security Level 4

All code types must be successfully read three times before being decoded.

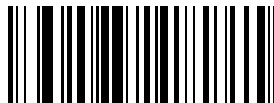

LINEAR SECURITY LEVEL 4

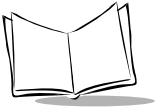

Bi-directional Redundancy

This parameter is only valid when a **Linear Code Type Security Level** (see page [5-78](#)) is enabled. When this parameter is enabled, a bar code must be successfully scanned in both directions (forward and reverse) before being decoded.



ENABLE BI-DIRECTIONAL REDUNDANCY



***DISABLE BI-DIRECTIONAL REDUNDANCY**

UPC/EAN Security Level

The Phaser offers four levels of decode security for UPC/EAN bar codes. Increasing levels of security are provided for decreasing levels of bar code quality. There is an inverse relationship between security and scanner aggressiveness, so be sure to choose only that level of security necessary for any given application.

UPC/EAN Security Level 0

This is the default setting which allows the scanner to operate in its most aggressive state, while providing sufficient security in decoding “in-spec” UPC/EAN bar codes.

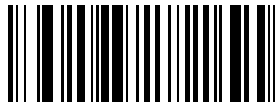

***UPC/EAN SECURITY LEVEL 0**

UPC/EAN Security Level 1

As bar code quality levels diminish, certain characters become prone to mis-decodes before others (i.e., 1, 2, 7, 8). If you are experiencing mis-decodes of poorly printed bar codes, and the mis-decodes are limited to these characters, select this security level.

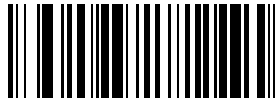

UPC/EAN SECURITY LEVEL 1

UPC/EAN Security Level 2

If you are experiencing mis-decodes of poorly printed bar codes, and the mis-decodes are not limited to characters 1, 2, 7, and 8, select this security level.



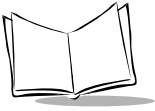

UPC/EAN SECURITY LEVEL 2

UPC/EAN Security Level 3

If you have tried Security Level 2, and are still experiencing misdecodes, select this security level. Be advised that selecting this option is an extreme measure against mis-decoding severely out of spec bar codes. Selection of this level of security significantly impairs the decoding ability of the scanner. If this level of security is necessary, you should try to improve the quality of your bar codes.



UPC/EAN SECURITY LEVEL 3

RS-232 Parameters

Baud Rate

Baud rate is the number of bits of data transmitted per second. The scanner's baud rate setting should match the data rate setting of the host device. If not, data may not reach the host device or may reach it in distorted form.



BAUD RATE 600



BAUD RATE 1200



BAUD RATE 2400

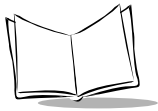

BAUD RATE 4800



***BAUD RATE 9600**



BAUD RATE 19200



BAUD RATE 38400

Parity

A parity check bit is the most significant bit of each ASCII coded character. Select the parity type according to host device requirements.

If you select **ODD** parity, the parity bit has a value 0 or 1, based on data, to ensure that an odd number of 1 bits are contained in the coded character.

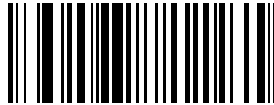

ODD

If you select **EVEN** parity, the parity bit has a value 0 or 1, based on data, to ensure that an even number of 1 bits are contained in the coded character.

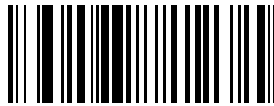

EVEN

Select **MARK** parity and the parity bit is always 1.



MARK

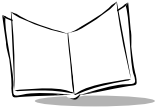

Select **SPACE** parity and the parity bit is always 0.



SPACE

If no parity is required, select **NONE**.

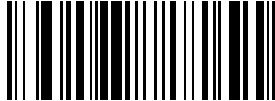

***NONE**

Check Receive Errors

Select whether or not the parity, framing, and overrun of received characters are checked. The type of parity used is selectable through the **PARITY** parameter.

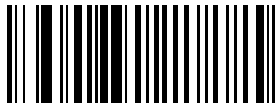

CHECK FOR RECEIVED ERRORS



***DO NOT CHECK FOR RECEIVED ERRORS**

Hardware Handshaking

The data interface consists of an RS-232 port. The port has been designed to operate either with or without the hardware handshaking lines, RTS, *Request to Send*, and CTS, *Clear to Send*.

If Standard RTS/CTS handshaking is selected, scan data is transmitted according to the following sequence:

- The scanner reads the CTS line for activity. If CTS is asserted, the scanner waits up to two seconds for the host to negate the CTS line. If, after two seconds (default), the CTS line is still asserted, the scanner sounds a transmit error and any scanned data is lost.
- When the CTS line is negated, the scanner asserts the RTS line and waits up to two seconds for the host to assert CTS. When the host asserts CTS, data is transmitted. If, after two seconds (default), the CTS line is not asserted, the scanner sounds a transmit error and discards the data.
- When data transmission is complete, the scanner negates RTS 10 msec after sending the last character.
- The host should respond by negating CTS. The scanner checks for a negated CTS upon the next transmission of data.

During the transmission of data, the CTS line should be asserted. If CTS is deasserted for more than 50 ms between characters, the transmission is aborted, the scanner sounds a transmission error, and the data is discarded.

If the above communications sequence fails, the scanner issues an error indication. In this case, the data is lost and must be rescanned.

If Hardware Handshaking and Software Handshaking are both enabled, Hardware Handshaking will take precedence.

Note: *The DTR signal is jumpered active.*

Note: *When using RTS/CTS handshaking and a cradle, there is an 8 ms delay for the information to travel between the host and the scanner. If this setup is necessary, scan the Intercharacter Delay bar code on page 5-94 and set the delay for 10 ms or more.*

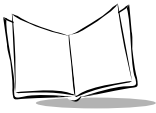

Scan the bar code below if no Hardware Handshaking is desired.

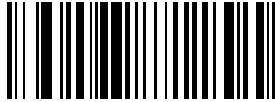

***NONE**

Scan the bar code below to select Standard RTS/CTS Hardware Handshaking.

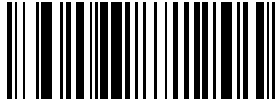

STANDARD RTS/CTS

When RTS/CTS Option 1 is selected, the cradle asserts RTS before transmitting and ignores the state of CTS. The scanner deasserts RTS when the transmission is complete.



RTS/CTS OPTION 1

When Option 2 is selected, RTS is always high or low (user-programmed logic level). However, the scanner waits for CTS to be asserted before transmitting data. If CTS is not asserted within two seconds (default), the scanner issues an error indication and discards the data.

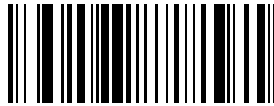

RTS/CTS OPTION 2

When Option 3 is selected, the scanner asserts RTS prior to any data transmission, regardless of the state of CTS. The scanner waits up to two seconds (default) for CTS to be asserted. If CTS is not asserted during this time, the scanner issues an error indication and discards the data. The scanner deasserts RTS when transmission is complete.

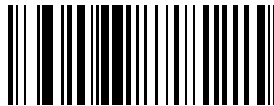

RTS/CTS OPTION 3

Software Handshaking

This parameter offers control of the data transmission process in addition to, or instead of, that offered by hardware handshaking. There are five options.

If Software Handshaking and Hardware Handshaking are both enabled, Hardware Handshaking takes precedence.

None

When this option is selected, data is transmitted immediately.

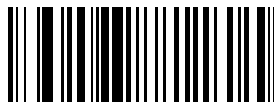

***NONE**

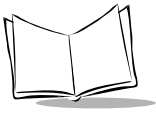

ACK/NAK

When this option is selected, after transmitting data, the cradle expects either an ACK, *Acknowledge*, or NAK, *Negative Acknowledge*, response from the host. Whenever a NAK is received, the cradle transmits the same data again and waits for either an ACK or NAK. After three unsuccessful attempts to send data when NAKs are received, the cradle issues an error indication and discards the data.

The cradle waits up to the programmable Host Serial Response Time-out to receive an ACK or NAK. If the cradle does not get a response in this time, it issues an error indication and discards the data. There are no retries when a time-out occurs.

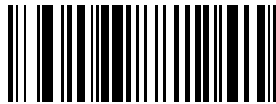

ACK/NAK

ENQ

When this option is selected, the cradle waits for an ENQ, *Enquiry*, character from the host before transmitting data. If an ENQ is not received within two seconds, the cradle issues an error indication and discards the data. The host must transmit an ENQ character at least every two seconds to prevent transmission errors.



ENQ

ACK/NAK with ENQ

This combines the two previous options.

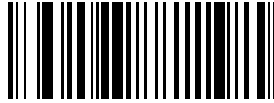

ACK/NAK with ENQ

XON/XOFF

An XOFF, *Transmit Off*, character turns the scanner transmission off until the scanner receives an XON, *Transmit On*, character. There are two situations for XON/XOFF:

- XOFF is received before the scanner has data to send. When the scanner has data to send, it then waits for an XON character before transmission. The scanner waits up to two seconds to receive the XON. If the XON is not received within this time, the scanner issues an error indication and discards the data.
- XOFF is received during a transmission. Data transmission then stops after sending the current byte. When the scanner receives an XON character, it sends the rest of the data message. The scanner waits indefinitely for the XON.

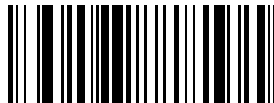

XON/XOFF

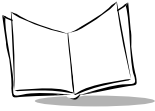

Host Serial Response Time-out

This parameter specifies how long the scanner waits for an ACK, NAK or CTS before determining that a transmission error has occurred. This only applies when in one of the ACK/NAK Software Handshaking modes, or RTS/CTS Hardware Handshaking option. The default time is set to 2 seconds.

The delay period can range from 0.0 to 9.9 seconds in 0.1 second increments. After scanning the bar code below, scan two numeric bar codes beginning on page [5-99](#). If you make an error, or wish to change your selection, scan *CANCEL* on page 5-101.



HOST SERIAL RESPONSE TIME-OUT

RTS Line State

Note: *This only applies to the scanner in corded mode. It has no affect when uploading data through the cradle.*

Scan the appropriate bar code below to set the idle state of the Serial Host RTS line. Choose LOW RTS line state or HIGH RTS line state.



*HOST: LOW RTS



HOST: HIGH RTS

Stop Bit Select

The stop bit(s) at the end of each transmitted character marks the end of transmission of one character and prepares the receiving device for the next character in the serial data stream. The number of stop bits (one or two) selected depends on the number the receiving terminal is programmed to accommodate. Set the number of stop bits to match host device requirements.

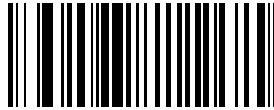

***1 STOP BIT**



2 STOP BITS

ASCII Format

This parameter allows the cradle to interface with devices requiring a 7-bit or 8-bit ASCII protocol.

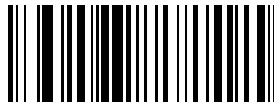

7-BIT

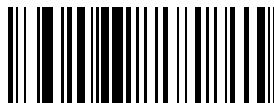

***8-BIT**

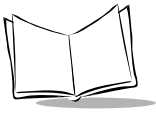

Beep on <BEL>

When this parameter is enabled, the scanner beeps when a <BEL> character is detected on the RS-232 serial line. <BEL> is issued to gain a user's attention to indicate an illegal entry or other important event.

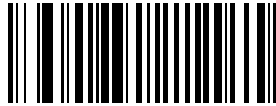

**BEEP ON <BEL> CHARACTER
(ENABLE)**

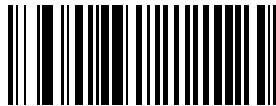

***DO NOT BEEP ON <BEL> CHARACTER
(DISABLE)**

Intercharacter Delay

Select the intercharacter delay option matching host requirements. The intercharacter delay gives the host system time to service its receiver and perform other tasks between characters. The delay period can range from no delay to 99 ms in 1 ms increments (if you are using a cradle and RTS/CTS handshaking, the delay period can range from 5 ms to 99 ms). After scanning the bar code below, scan two bar codes beginning on page [5-99](#) to set the desired time-out. If you make an error, or wish to change your selection, scan *CANCEL* on page 5-101. The default time is set to 0.

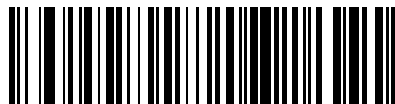

INTERCHARACTER DELAY

MCL-Net Parameters

MCL-Net Baud Rate

Baud rate is the number of bits of data transmitted per second. Scan the appropriate bar code below to set the MCL-Net baud rate. The default baud rate is 38400.



BAUD RATE 600



BAUD RATE 1200



BAUD RATE 2400

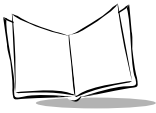

BAUD RATE 4800



BAUD RATE 9600



BAUD RATE 19200



***BAUD RATE 38400**

MCL-Net Hex Addressing Mode

Scan the appropriate bar code below to set the MCL-Net Hex addressing mode. The default mode is *Disabled*.



***MCL-NET HEX ADDRESSING DISABLED**



MCL-NET HEX ADDRESSING ENABLED

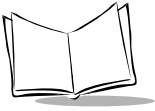

Scanner Address

Scan the following barcode, followed by 3 digits from the numeric barcode section (starting on page 5-99), to set the address of the scanner (scanner ID). The default address is set to 001.

The number of scanner addresses (scanner ID's) varies with the selected communication protocol.

- RS-232/Synapse range from 001 to 254
- MCL Link Lite (MCL Net) range from 001 to 002
- MCL Link (MCL Net) range from 001 to 254



SCANNER ADDRESS

MCL-Net Transmit Retries

Scan the following barcode, followed by 2 digits from the numeric barcode section (starting on page 5-99), to define the number of retries in the range 1 to 10. The default is set to 3 retries.



MCL-NET RETRIES

MCL-Net Frame Timeout

Scan the following barcode, followed by 2 digits from the numeric barcode section (starting on page 5-99), to define the amount of time to wait for an ACK or NAK from the host before retransmitting. The timeout is in 100 ms increments in the range 100 ms to 3000 ms. The default time is set to 500 ms.



MCL-NET FRAME TIMEOUT

Numeric Bar Codes

For parameters requiring specific numeric values, scan the appropriately numbered bar code(s).



0

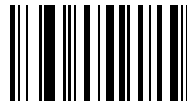

1



2



3

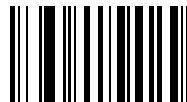

4

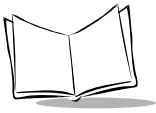

Numeric Bar Codes (Continued)



5

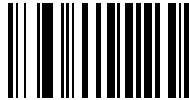

6

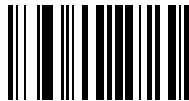

7



8

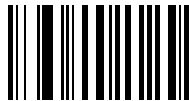

9

Numeric Bar Codes (Continued)

Cancel

If you make an error, or wish to change your selection, scan the bar code below.



CANCEL

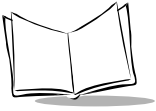

P460/P360 Memory Scanners Product Reference Guide

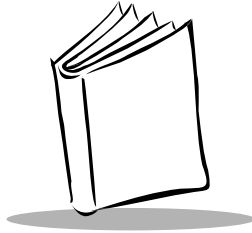

Appendix A

Bar Code Information

UCC/EAN-128

UCC/EAN-128 is a convention for printing data fields with standard Code 128 bar code symbols. UCC/EAN-128 symbols are distinguished by a leading FNC 1 character as the first or second character in the symbol. Other FNC 1 characters are used to delineate fields.

When EAN-128 symbols are read, they are transmitted after special formatting strips off the leading FNC 1 character and replaces other FNC 1 characters with the ASCII 29 GS control character.

When AIM symbology identifiers are transmitted, the modifier character indicates the position of the leading FNC 1 character according to AIM guidelines. For example, **jc1** indicates a UCC/EAN-128 symbol with a leading FNC1 character.

Standard Code 128 bar codes which do not have a leading FNC 1 may still be used, but are not encoded according to the EAN-128 convention. Standard Code 128 and UCC/EAN-128 may be mixed in an application. The P460/P360 autodiscriminates between these symbols and can enable or disable one or both code types via bar code menus. The following table indicates the behavior of the P460/P360 in each of the four possible parameter settings.

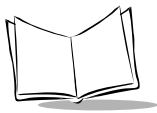

Table A-1. Reading Standard Code128 & UCC/EAN 128

Standard Code 128	UCC/EAN-128	Effect and Example
Disable	Disable	No Code 128 symbols can be read.
Disable	Enable	<p>Read only symbols with leading FNC 1.</p> <p>Examples: FNC1ABCD^{FNC1}E will be read as ABCD²⁹E A^{FNC1}BCD^{FNC1}E will be read as ABCD²⁹E FNC1FNC1ABCD^{FNC1}E will be read as ABCD²⁹E ABCD^{FNC1}E can not be read ABCDE can not be read</p>
Enable	Disable	<p>Read only symbols without leading FNC 1.</p> <p>Examples: FNC1ABCD^{FNC1}E can not be read A^{FNC1}BCD^{FNC1}E can not be read FNC1FNC1ABCD^{FNC1}E can not be read ABCD^{FNC1}E will be read as ABCD²⁹E ABCDE will be read as ABCDE</p>
Enable	Enable	<p>Read both types of symbols.</p> <p>Examples: FNC1ABCD^{FNC1}E will be read as ABCD²⁹E A^{FNC1}BCD^{FNC1}E will be read as ABCD²⁹E FNC1FNC1ABCD^{FNC1}E will be read as ABCD²⁹E ABCD^{FNC1}E will be read as ABCD²⁹E ABCDE will be read as ABCDE</p>

AIM Code Identifiers

Each AIM Code Identifier contains the three-character string]cm where:

-] = Flag Character (ASCII 93)
- c = Code Character (see Table A-2)
- m = Modifier Character (see Table A-3)

Table A-2. Code Characters

Code Character	Code Type
A	Code 39
C	Code 128 (all variants)
E	UPC/EAN
F	Codabar
G	Code 93
H	Code 11
I	Interleaved 2 of 5
M	MSI Plessey
S	D2 of 5, IATA 2 of 5
X	Bookland EAN, Code 39 Trioptic, Coupon Code

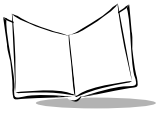

The modifier character is the sum of the applicable option values based on the following table.

Table A-3. Modifier Characters

Code Type	Option Value	Option
Code 39	0	No check character or Full ASCII processing.
	1	Reader has checked one check character.
	3	Reader has checked and stripped check character.
	4	Reader has performed Full ASCII character conversion.
	5	Reader has performed Full ASCII character conversion and checked one check character.
	7	Reader has performed Full ASCII character conversion and checked and stripped check character.
Example: A Full ASCII bar code with check character W, A+I+MI+DW , is transmitted as J A7AimId where 7 = (3+4).		
Trioptic Code 39	0	No option specified at this time. Always transmit 0.
	Example: A Trioptic bar code 412356 is transmitted as J X0412356	
Code 128	0	Standard data packet, no Function code 1 in first symbol position.
	1	Function code 1 in first symbol character position.
	2	Function code 1 in second symbol character position.
	Example: A Code (EAN) 128 bar code with Function 1 character in the first position, FNC1 Aim Id is transmitted as J C1AimId	
I 2 of 5	0	No check digit processing.
	1	Reader has validated check digit.
	3	Reader has validated and stripped check digit.
	Example: An I 2 of 5 bar code without check digit, 4123, is transmitted as J I04123	

Table A-3. Modifier Characters (Cont'd)

Code Type	Option Value	Option
Codabar	0	No check digit processing.
	1	Reader has checked check digit.
	3	Reader has stripped check digit before transmission.
	Example: A Codabar bar code without check digit, 4123, is transmitted as JF0 4123	
Code 93	0	No options specified at this time. Always transmit 0.
	Example: A Code 93 bar code 012345678905 is transmitted as JG0 012345678905	
MSI Plessey	0	Single check digit checked.
	1	Two check digits checked.
	2	Single check digit verified and stripped before transmission.
	3	Two check digits verified and stripped before transmission.
	Example: An MSI Plessey bar code 4123, with a single check digit checked, is transmitted as JM0 4123	
D 2 of 5	0	No options specified at this time. Always transmit 0.
	Example: A D 2 of 5 bar code 4123, is transmitted as JS0 4123	
UPC/EAN	0	Standard packet in full EAN country code format, which is 13 digits for UPC-A and UPC-E (not including supplemental data).
	1	Two-digit supplement data only.
	2	Five-digit supplement data only.
	4	EAN-8 data packet.
	Example: A UPC-A bar code 012345678905 is transmitted as JE0 0012345678905	
Bookland EAN	0	No options specified at this time. Always transmit 0.
	Example: A Bookland EAN bar code 123456789X is transmitted as JX0 123456789X	

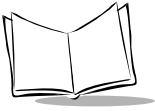

According to AIM standards, a UPC with supplemental bar code is transmitted in one of the following formats:

JE0 (UPC chars) (terminator) **JE2** (supplemental) (terminator) or

JE2 (supplemental) (terminator) **JE0** (UPC chars) (terminator)

In the Phaser, however, the format is changed to:

JE0 (UPC chars) **JE2** (supplemental)

Therefore, a UPC with two supplemental characters, 01234567890510, is transmitted to the host as a 21-character string, **JE00012345678905JE110**.

Symbol Code Identifier Characters

Table A-4. Symbol Code Identifier Characters

Code Type	Symbol Identifier
UPC-A, UPC-E, EAN-13, EAN-8	A
Code 39	B
Codabar	C
Code 128	D
Code 93	E
Interleaved 2 of 5	F
Discrete 2 of 5, D 2 of 5 IATA	G
MSI Plessey	J
UCC/EAN 128	K
Bookland EAN	L
Trioptic Code 39	M

Table A-5. ASCII Character Set

ASCII Value	Full ASCII Code 39 Encode Char.	Keystroke	ASCII Value	Full ASCII Code 39 Encode Char	Keystroke
1000	%U	CTRL 2	1024	\$X	CTRL X
1001	\$A	CTRL A	1025	\$Y	CTRL Y
1002	\$B	CTRL B	1026	\$Z	CTRL Z
1003	\$C	CTRL C	1027	%A	CTRL [
1004	\$D	CTRL D	1028	%B	CTRL \
1005	\$E	CTRL E	1029	%C	CTRL]
1006	\$F	CTRL F	1030	%D	CTRL 6
1007	\$G	CTRL G	1031	%E	CTRL -
1008	\$H	CTRL H	1032	Space	Space
1009	\$I	CTRL I	1033	/A	!
1010	\$J	CTRL J	1034	/B	'
1011	\$K	CTRL K	1035	/C	#
1012	\$L	CTRL L	1036	/D	\$
1013	\$M	CTRL M	1037	/E	%
1014	\$N	CTRL N	1038	/F	&
1015	\$O	CTRL O	1039	/G	'
1016	\$P	CTRL P	1040	/H	(
1017	\$Q	CTRL Q	1041	/I)
1018	\$R	CTRL R	1042	/J	*
1019	\$S	CTRL S	1043	/K	+
1020	\$T	CTRL T	1044	/L	,
1021	\$U	CTRL U	1045	-	-
1022	\$V	CTRL V	1046	.	.
1023	\$W	CTRL W	1047	/	/

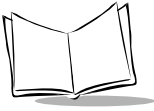

Table A-5. ASCII Character Set (Cont'd)

ASCII Value	Full ASCII Code 39 Encode Char.	Keystroke	ASCII Value	Full ASCII Code 39 Encode Char	Keystroke
1048	0	0	1073	I	I
1049	1	1	1074	J	J
1050	2	2	1075	K	K
1051	3	3	1076	L	L
1052	4	4	1077	M	M
1053	5	5	1078	N	N
1054	6	6	1079	O	O
1055	7	7	1080	P	P
1056	8	8	1081	Q	Q
1057	9	9	1082	R	R
1058	/Z	:	1083	S	S
1059	%F	;	1084	T	T
1060	%G	<	1085	U	U
1061	%H	=	1086	V	V
1062	%I	>	1087	W	W
1063	%J	?	1088	X	X
1064	%V	@	1089	Y	Y
1065	A	A	1090	Z	Z
1066	B	B	1091	%K	[
1067	C	C	1092	%L	\
1068	D	D	1093	%M]
1069	E	E	1094	%N	^
1070	F	F	1095	%O	_
1071	G	G	1096	%W	'
1072	H	H	1097	+A	a

Table A-5. ASCII Character Set (Cont'd)

ASCII Value	Full ASCII Code 39 Encode Char.	Keystroke	ASCII Value	Full ASCII Code 39 Encode Char	Keystroke
1098	+B	b	1113	+Q	q
1099	+C	c	1114	+R	r
1100	+D	d	1115	+S	s
1101	+E	e	1116	+T	t
1102	+F	f	1117	+U	u
1103	+G	g	1118	+V	v
1104	+H	h	1119	+W	w
1105	+I	i	1120	+X	x
1106	+J	j	1121	+Y	y
1107	+K	k	1122	+Z	z
1108	+L	l	1123	%P	{
1109	+M	m	1124	%Q	
1110	+N	n	1125	%R	}
1111	+O	o	1126	%S	~
1112	+P	p	1127		Undefined

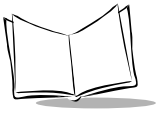

Table A-5. ASCII Character Set (Cont'd)

ALT Keys	Keystroke	ALT Keys	Keystroke	ALT Keys	Keystroke
2064	ALT 2	2075	ALT K	2086	ALT V
2065	ALT A	2076	ALT L	2087	ALT W
2066	ALT B	2077	ALT M	2088	ALT X
2067	ALT C	2078	ALT N	2089	ALT Y
2068	ALT D	2079	ALT O	2090	ALT Z
2069	ALT E	2080	ALT P	2091	ALT [
2070	ALT F	2081	ALT Q	2092	ALT \
2071	ALT G	2082	ALT R	2093	ALT]
2072	ALT H	2083	ALT S	2094	ALT 6
2073	ALT I	2084	ALT T	2095	ALT -
2074	ALT J	2085	ALT U		
Misc. Key	Keystroke	Misc. Key	Keystroke	Misc. Key	Keystroke
3001	PA 1	3009	CMD 7	3017	°
3002	PA 2	3010	CMD 8	3018	1/2
3003	CMD 1	3011	CMD 9	3019	¶
3004	CMD 2	3012	CMD 10	3020	§
3005	CMD 3	3013	¥	3021	
3006	CMD 4	3014	£	3022	0/00
3007	CMD 5	3015	¤		
3008	CMD 6	3016	¬		

Table A-5. ASCII Character Set (Cont'd)

PF Keys	Keystroke	PF Keys	Keystroke	PF Keys	Keystroke
4001	PF 1	4009	PF 9	4017	PF 17
4002	PF 2	4010	PF 10	4018	PF 18
4003	PF 3	4011	PF 11	4019	PF 19
4004	PF 4	4012	PF 12	4020	PF 20
4005	PF 5	4013	PF 13	4021	PF 21
4006	PF 6	4014	PF 14	4022	PF 22
4007	PF 7	4015	PF 15	4023	PF 23
4008	PF 8	4016	PF 16	4024	PF 24
F Keys	Keystroke	F Keys	Keystroke	F Keys	Keystroke
5001	F 1	5014	F 14	5027	F 27
5002	F 2	5015	F 15	5028	F 28
5003	F 3	5016	F 16	5029	F 29
5004	F 4	5017	F 17	5030	F 30
5005	F 5	5018	F 18	5031	F 31
5006	F 6	5019	F 19	5032	F 32
5007	F 7	5020	F 20	5033	F 33
5008	F 8	5021	F 21	5034	F 34
5009	F 9	5022	F 22	5035	F 35
5010	F 10	5023	F 23	5036	F 36
5011	F 11	5024	F 24	5037	F 37
5012	F 12	5025	F 25	5038	F 38
5013	F 13	5026	F 26	5039	F 39

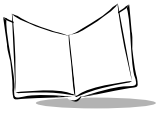

Table A-5. ASCII Character Set (Cont'd)

Numeric Keypad	Keystroke	Numeric Keypad	Keystroke	Numeric Keypad	Keystroke
6042	*	6049	1	6056	8
6043	+	6050	2	6057	9
6044	Undefined	6051	3	6058	Enter
6045	-	6062	4	6059	Num Lock
6046	.	6063	5	6060	00
6047	/	6064	6		
6048	0	6065	7		
Extended Keypad	Keystroke	Extended Keypad	Keystroke	Extended Keypad	Keystroke
7001	Break	7008	Backspace	7015	Up Arrow
7002	Delete	7009	Tab	7016	Dn Arrow
7003	Pg Up	7010	Print Screen	7017	Left Arrow
7004	End	7011	Insert	7018	Right Arrow
7005	Pg Dn	7012	Home	7019	Back Tab
7006	Pause	7013	Enter		
7007	Scroll Lock	7014	Escape		



Appendix B

Automatic Project Download

The Phaser P470/P370 RF scanner is shipped from the factory with a pre-installed default application. This fully functional application allows the scanner to be used “out of the box”. If you need to load your own application into the scanner, the “Automatic Project Download” feature will simplify the process.

When the default application is running, and the scanner is placed into its paired cradle, the scanner will query the *MCL-Link* host for data in a file named “PHASER.CFG”. The scanner will use the information in this file to find the project directory which the user wishes to have loaded into the scanner, and will then execute the PROJECT.CMD” script which exists in the directory. This script will automatically download all program and data files relevant to the project to the scanner and will reset the scanner making it ready to run the user’s application.

In order to utilize this mechanism, the user needs only generate the PHASER.CFG file and place it in the directory specified in the *MCL-Link* setup screen as the “General path for data files”. Any text editor may be used to create this file; the contents of the file are as follows:

```
x|<path name to the user’s project>
```

The X| at the beginning of the line are required for the MCL-Net CR command to recognize this file and read the data. The path name should include the entire path hierarchy. Also, all backslashes (\) in the path name should be replaced with the string “\5C”, so that the MCL code running on the scanner does not inadvertently convert part of the path name to the equivalent Hex Character.

An example PHASER.CFG file is shown below:

```
x|c:\5Cmcl-p460\5Cdesigner\5Csample1.prj
```

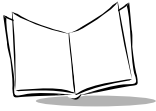

Note that designer always appends the .prj suffix to the directories it creates to store project files.

The PROJECT.CMD file will be automatically generated by the MCL-Designer application.



Appendix C

Messages and Error Codes

Introduction

This chapter contains information on messages displayed on the scanner.

Messages

The scanner displays messages when certain actions are performed. If the scanner displays a message that is unfamiliar, contact the *Symbol Support Center* on page -xi.

Table C-1. Scanner Messages

Message	Description
Unit Cradled	Scanner is properly inserted in the cradle
Battery Temperature Out Of Range	Battery temperature is out of range. Contact a <i>Symbol Support Center</i> on page -xi.
Upload Failed. Retry <Enter>=Yes <BK>=No	<ul style="list-style-type: none">• After putting the scanner in the mode to transmit batch data to the host, it was not placed in the cradle or attached to a cable within the required 30 seconds.• Communication failure with host due to host or cabling problems. Use the beeper indications to track the message. See <i>Beeper Indications</i> on page 4-9.

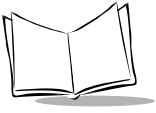

P460/P360 Memory Scanners Product Reference Guide

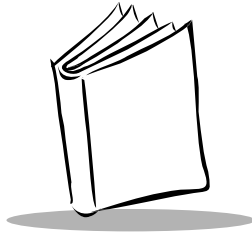

Index

Numerics

123Scan 3-17

A

accessories 4-5
ADF rules 3-17
AIM Code Identifiers A-3
aiming
 hold at an angle 3-23
 scan the entire symbol 3-22
alpha-numeric data entry 3-3, 3-26
ambient light immunity
 artificial light 4-6
 sunlight 4-6
app control
 bar code 1-4, 3-11, 3-12
application downloads 3-11
ASCII Character Set A-7
ASCII Format 5-6

B

bar codes
 beeper tone 5-21
 beeper volume 5-22
 bi-directional redundancy 5-80
 codabar 5-5
 CLSI editing 5-70
 enable/disable 5-67
 NOTIS editing 5-71
 set lengths 5-68, 5-69
 code 128 5-3
 enable/disable 5-42
 ISBT 128 5-45

 lengths 5-44
 UCC/EAN-128 5-43
 code 39 5-4
 check digit verification 5-50
 code 32 prefix 5-54
 code 39 to code 32 5-53
 enable/disable 5-46
 enable/disable full ASCII 5-52
 enable/disable trioptic 5-47
 set lengths 5-48, 5-49
 transmit check digit 5-51
 code 93 5-4
 enable/disable code 93 5-55
 set lengths 5-56, 5-57
 convert code 39 to code 32 5-53
 date format 5-17
 date separator 5-14
 decimal separator 5-16
 discrete 2 of 5 5-4
 enable/disable 5-64
 set lengths 5-65, 5-66
 hour type 5-15
 interleaved 2 of 5 5-4
 check digit verification 5-61
 convert to EAN-13 5-63
 enable/disable 5-58
 set lengths 5-59, 5-60
 transmit check digit 5-62
 key click 5-18
 laser on time 5-19
 linear code security 5-78
 load new app 1-4, 3-12
 load new app/file 3-11
 MSI Plessey 5-5

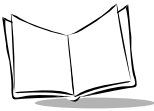

- enable/disable 5-72
- set lengths 5-73, 5-74
- transmit check digit 5-76
- MSI plessey
 - check digit algorithm 5-77
 - check digits 5-75
- numeric bar codes ... 5-99, 5-100, 5-101
- set default 5-7
- sleep time 5-13
- system code 3-13
- system menu 1-4, 3-8
- UPC/EAN 5-3
 - bookland EAN 5-31
 - convert UPC-E to UPC-A 5-38
 - convert UPC-E1 to UPC-A 5-39
 - coupon code 5-41
 - decode supplements 5-32
 - EAN zero extend 5-40
 - EAN-8/EAN-13 5-29, 5-30
 - enable/disable 5-26, 5-27, 5-28
 - security level 5-81
 - supplemental redundancy 5-33
 - UPC-A preamble 5-35
 - UPC-A/UPC-E/UPC-E1 5-34
 - UPC-E preamble 5-36
 - UPC-E1 preamble 5-37
- Batch/Inventory Application 3-2
 - communication protocol 3-2, 3-9, 5-8
 - reviewing/deleting batch records 3-5
 - transmitting data to host 3-6
- battery 1-1
 - battery temperature range message .. B-1
 - changing/replacing 2-7
 - charging 2-5, 2-6, 4-9
 - checking battery charge level 3-14
- Baud Rate 5-6, 5-95
- Beeper
 - Beep After Good Decode 5-2
 - Beep on 5-6
 - beeper indications 4-9
 - Beeper Tone 5-2, 5-21
 - Beeper Volume 5-2, 5-22
- beeper operation 4-6
- Bi-directional Redundancy 5-5

- Bookland EAN 5-3
- boot up the scanner 3-1

C

- cable 2-2
- carriage return 3-17, 3-18
- charge status indicator light 1-2
- charge status LED indications 2-6
- charging the battery 2-5, B-1
- Check Receive Errors 5-6
- clock 3-9, 5-15
- CLSI Editing 5-5
- Codabar 5-5
- Code 128 5-3
- Code 32 Prefix 5-4
- Code 39 5-4
- Code 39 Check Digit Verification 5-4
- Code 39 Full ASCII Conversion 5-4
- Code 93 5-4
- code identifier A-3
- communication protocol 3-2, 5-8
 - batch/inventory app 3-2, 3-9, 5-8
 - MCL-Net 3-9, 5-9, 5-95
 - RS232 5-83
 - RS-232 3-9, 5-9
 - scan & transmit app 3-2, 3-9, 5-8
 - Synapse 2-9, 2-10, 3-9, 5-8
- connecting to a host 2-8
 - RS-232 2-8
- conventions
 - notational x
- Convert Code 39 to Code 32 5-4
- Convert I 2 of 5 to EAN 13 5-4
- Convert UPC-E to A 5-3
- Convert UPC-E1 to A 5-3
- cradle 1-2
 - charging in the cradle 2-5
 - daisy chaining cradles 2-4, 3-6
 - description of basic operation ... 1-2, 2-6
 - LED indicator status 2-6
 - pin outs 4-7
 - setting up the cradle 2-4, 2-9

D

Daisy-Chaining Cradles2-4, 3-6, 4-7
 data
 transmitting to host 3-6
 data formatting 3-17
 Date Format 5-2
 Date Separator 5-2
 dead zone 3-23
 Decimal Separator 5-2
 decode depth of field 3-25
 decode options 5-25
 decode symbologies/capability 4-6
 Decode UPC/EAN
 Supplemental Redundancy 5-3
 Decode UPC/EAN Supplementals 5-3
 Default Applications 3-1
 Batch/Inventory Application 3-2
 Scan and Transmit Application 3-7
 default settings 5-2
 resetting default application 3-12
 resetting default scanning parameters 5-7
 table of default parameters 5-2
 default table 5-2
 deleting stored records 3-5
 depth of field/decode zone 3-25
 dimensions 4-6
 Discrete 2 of 5 5-5
 downloading 3-11
 ADF rules 3-17
 automatic upgrade process A-1
 batch data to host 3-6
 files/lookup tables 3-11
 new/upgraded applications 3-11
 durability 4-6

E

EAN-13 5-3
 EAN-8 5-3
 EAN-8 Zero Extend 5-3
 eliminating repetitive scanning 3-4
 ENABLE UPC-E1 5-28
 Erase File 3-15
 error beep sequences 4-9

error messages and codes B-1
 Exit System Menu 3-16

F

file downloads 3-11
 firmware version 3-8, 3-16
 formatting data 3-17

H

Hardware Handshaking 5-6
 host
 data upload 3-6
 Host Serial Response Time-out 5-6
 Hour Type 5-2
 humidity 4-6

I

I 2 of 5 Check Digit Verification 5-4
 Information
 Service x
 instructions
 quick startup 1-3
 Intellistand 4-5
 Intercharacter Delay 5-6
 Interleaved 2 of 5 5-4
 inventory application
 see batch/inventory application 3-2
 ISBT-128 5-4

K

Key Click 5-2
 keypad
 access the system menu 3-8
 alpha data entry 3-3
 enabling/disabling the keypad 3-26
 entering
 a blank space 3-27
 a dash 3-27
 a decimal point 3-27
 example keying in data 3-26, 3-27
 manually resetting the scanner ... 3-1, 4-2
 operation and layout 3-26

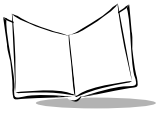

quantity entry 3-4
reviewing/deleting batch records 3-5

L

laser classification 4-6
Laser On Time 5-2
LED status on cradle 2-6
Linear Code Type Security Levels 5-5
loading new applications 3-11
loading new/updated files/tables 3-11
lookup table downloads 3-11

M

maintenance 4-1
Manual Data Entry
 alpha data 3-3, 3-26
 decimal points 3-27
 example keying in data 3-26
 numeric data 3-3
maximum tilt angles 3-23
MCL-Net 3-9, 5-98
 MCL-Net Baud Rate 5-6, 5-95
 MCL-Net Frame Timeout 5-6, 5-98
 MCL-Net Hex Addressing Mode . 5-6, 5-97
 MCL-Net Parameters 5-95
 MCL-Net Transmit Retries 5-6, 5-98
memory on board scanner 3-22
MSI Plessey 5-5
MSI Plessey Check Digit Algorithm 5-5
MSI Plessey Check Digits 5-5

N

notational conventions x
NOTIS Editing 5-5
numeric data entry 3-3, 3-26

O

Operational parameters 5-1

P

parameters
 clear an ADF rule 3-17
 reset default application 3-12
 set all defaults 5-7
 table of default settings 5-2
Parity 5-6
pin outs
 cradle 4-7
 scanner 4-8
pitch 4-6
Power Detect Beep 5-2, 5-23
power options 2-4
presentation scanning 4-5
print contrast minimum 4-6

Q

quick startup instructions 1-3

R

reboot scanner 3-1, 4-2
records
 deleting 3-5
Related Publication x
resetting the scanner 3-1, 4-2
Returns to Application 3-16
Reviewing Stored Records 3-5
roll tolerance 4-6
RS232
 ASCII format 5-93
 baud rate 5-83
 check receiver errors 5-86
 handshaking 5-90
 hardware handshaking 5-87
 host serial response time-out 5-92
 host type 5-6
 intercharacter delay 5-94
 parity 5-85
 RTS line state 5-92
 software handshaking 5-89
 stop bit select 5-93
RTS Line State (cable use only) 5-6

S

sample symbols 3-24

Scan and Transmit Application

- communication protocol . 3-2, 3-9, 5-2, 5-8
- manual alphanumeric entry 3-3, 3-7
- quantity entry 3-4, 3-7

scan repetition rate 4-6

scan stand options 4-5

scanner address 5-6, 5-98

scanner emits transmit errors 4-3

scanner ID 3-9, 5-98

scanner pin outs 4-7

Scanning Made Easy 1-1

Service Information x

Set Default Parameter 5-2

set defaults

- clearing ADF rules 3-17
- default application 3-12
- default scanning parameters 5-7

set length(s)

- Codabar 5-5
- Code 39 5-4
- Code 93 5-4
- D 2 of 5 5-5
- I 2 of 5 5-4
- MSI Plessey 5-5

Set Scanner ID 3-9

set time 3-9, 5-15

setup

- quick startup instructions 1-3
- sleep time 5-2, 5-13
- Software Handshaking 5-6

software version

- see firmware version 3-8, 3-16

specular reflection 3-23

stay awake 5-13

Stop Bit Select 5-6

stored records

- deleting 3-5

suffix values

- Enter (carriage return) 3-18
- Tab 3-20

symbol code identifier A-3

symbol code identifier characters A-6

symbol support center xi

Synapse connectivity .. 2-9, 2-10, 3-2, 3-9, 5-8

system code

- bar code 3-13

system menu 3-8

- accessing 3-8
- Back To Main 3-9, 3-13, 3-14
- Battery Check 3-14
- Erase File 3-15
- load new app/file 3-11
- Set Contrast 3-9
- Set Date 3-9
- Set Default Params 3-14
- set time 3-9
- version 3-8, 3-16

T

tab 3-20

table, lookup downloads 3-11

technical specifications 4-6

temperature

- battery B-1
- operating 4-6
- storage 4-6

test symbols 3-24

time 3-9, 5-15

Transmit

- I 2 of 5 Check Digit 5-4
- MSI Plessey Check Digit 5-5
- UPC-A Check Digit 5-3
- UPC-E Check Digit 5-3
- UPC-E1 Check 5-3
- "No Read" Message 5-2
- Transmit Code 39 Check Digit 5-4
- Trioptic Code 39 5-4

troubleshooting 4-2

- messages and error codes B-1

U

UCC/EAN-128 5-4, A-1

unit cradled message 2-5, B-1

unpacking 2-1

UPC-A 5-3

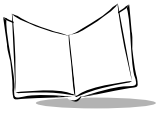

UPC-A Preamble 5-3
UPC-E 5-3
UPC-E Preamble 5-3
UPC-E1 5-3
UPC-E1 Preamble 5-3
UPC/EAN Coupon Code 5-3
UPC/EAN Security Levels 5-5

V

version 3-8, 3-16

W

wake up 3-2
working range 4-6

Y

yaw 4-6

Tell Us What You Think...

We'd like to know what you think about this Manual. Please take a moment to fill out this questionnaire and fax this form to: (631) 738-3318, or mail to:

Symbol Technologies, Inc.
One Symbol Plaza M/S B-4
Holtsville, NY 11742-1300
Attention: Technical Publications Manager

IMPORTANT: If you need product support, please call the appropriate customer support number provided. Unfortunately, we cannot provide customer support at the fax number above.

User's Manual Title: _____
(please include revision level)

How familiar were you with this product before using this manual?

Very familiar Slightly familiar Not at all familiar

Did this manual meet your needs? If not, please explain.

What topics need to be added to the index, if applicable?

What topics do you feel need to be better discussed? Please be specific.

What can we do to further improve our manuals?

Thank you for your input—We value your comments.

Quick Startup Instructions

Below is an index of Quick Startup Instructions to help get you up and going quickly. These instructions are also on the back cover of this guide for easy reference. The index is listed in a step by step order beginning with step 1, Setting up the System.

Mandatory steps are designated by an asterisk (*). If an item has multiple pages referenced, the most important reference is in bold.

	PRG Page
1. Setting Up the System	
• Connecting to a host *	2-8
- Using a cradle	1-2, 2-4 , 3-6
- Using a cabled scanner	2-2 , 2-6
- RS-232 connection	2-8
- Synapse connection (keyboard wedge, USB, etc.)	2-9 , 2-10
• Charging the battery *	2-5 , 1-2
2. Using the Default Applications	
• Overview of Batch/Inventory application (Uncorded operation) *	3-2
- Reviewing/deleting stored records	3-5
- Transmitting batch/stored data to the host	3-6
• Overview of Scan and Transmit application (Corded operation) *	3-7
• Keypad operation	3-3, 3-26
• Eliminating repetitive scanning	3-4
• Selecting the host communication protocol	3-2, 3-9, 5-8 , 5-8
- RS-232 baud rate	5-83
3. Programming an Advanced Data Formatting Rule Using 123Scan	3-17
• Suffix values (appending Enter key and Tab)	3-18 , 3-20
4. Troubleshooting Problems	
• Troubleshooting table	4-2
• Messages and error codes	B-1
• Beeper indications	4-9
• Cradle LED indications	1-2, 2-6



70-37690-04

Revision A — December 2003

Symbol Technologies, Inc. One Symbol Plaza, Holtsville N.Y. 11742-1300