



ES400

User Guide



ES400
User Guide

72E-136310-01

Rev. A

September 2010

© 2010 by Motorola, Inc. All rights reserved.

No part of this publication may be reproduced or used in any form, or by any electrical or mechanical means, without permission in writing from Motorola. This includes electronic or mechanical means, such as photocopying, recording, or information storage and retrieval systems. The material in this manual is subject to change without notice.

The software is provided strictly on an “as is” basis. All software, including firmware, furnished to the user is on a licensed basis. Motorola grants to the user a non-transferable and non-exclusive license to use each software or firmware program delivered hereunder (licensed program). Except as noted below, such license may not be assigned, sublicensed, or otherwise transferred by the user without prior written consent of Motorola. No right to copy a licensed program in whole or in part is granted, except as permitted under copyright law. The user shall not modify, merge, or incorporate any form or portion of a licensed program with other program material, create a derivative work from a licensed program, or use a licensed program in a network without written permission from Motorola. The user agrees to maintain Motorola’s copyright notice on the licensed programs delivered hereunder, and to include the same on any authorized copies it makes, in whole or in part. The user agrees not to decompile, disassemble, decode, or reverse engineer any licensed program delivered to the user or any portion thereof.

Motorola reserves the right to make changes to any software or product to improve reliability, function, or design.

Motorola does not assume any product liability arising out of, or in connection with, the application or use of any product, circuit, or application described herein.

No license is granted, either expressly or by implication, estoppel, or otherwise under any Motorola, Inc., intellectual property rights. An implied license only exists for equipment, circuits, and subsystems contained in Motorola products.

MOTOROLA and the Stylized M Logo and Symbol and the Symbol logo are registered in the US Patent & Trademark Office. Bluetooth is a registered trademark of Bluetooth SIG. Microsoft, Windows and ActiveSync are either registered trademarks or trademarks of Microsoft Corporation. All other product or service names are the property of their respective owners.

Motorola, Inc.
One Motorola Plaza
Holtsville, New York 11742-1300
<http://www.motorola.com/enterprisemobility>

Table of Contents

About This Guide

Introduction	xv
Documentation Set	xv
Configurations.....	xv
Software Versions.....	xvi
Chapter Descriptions	xvi
Notational Conventions.....	xvii
Related Documents	xvii
Service Information.....	xviii

Chapter 1: Getting Started

Unpacking	1-1
Setting Up the ES400	1-2
Remove the Battery Cover	1-2
Installing a microSD Card	1-2
Installing the SIM Card (GSM Only)	1-4
Installing the Battery	1-5
Powering On the ES400 for the First Time	1-6
Network Activation	1-7
Power Off the ES400	1-8
Suspend	1-8
Removing the microSD Card	1-9
Removing the SIM Card	1-9
Installing the Tether	1-10

Chapter 2: Using the ES400

Introduction	2-1
Features	2-1
Keypads	2-2
Special Characters	2-2
Keypad Remapping	2-2
Entering Data	2-2
Screen Navigation	2-3

Finger Scrolling	2-4
Motorola Home Screen	2-5
Status Bar	2-5
Cards	2-7
Simple Home Card	2-7
Full Home Card	2-8
Weather Card	2-9
Time Tracker Card	2-9
Program Shortcuts	2-9
My Apps Window	2-10
Tile Bar	2-10
Device Management	2-13
Programs	2-13
Memory Manager	2-14
Sound Profiles	2-14
Power & Radio	2-15
Alarms	2-17
Fusion	2-17
Status	2-18
Settings	2-18
Adjusting Volume	2-19
Charging the ES400	2-19
Charging Temperature	2-20
Battery Status Indications	2-20
Printing	2-20
Resetting the ES400	2-21
Locking the ES400	2-21
Password Unlocking	2-21
Finger Swipe Un-locking	2-22
Notifications When ES400 is Locked	2-22

Chapter 3: Making Calls

Introduction	3-1
Making a Call	3-1
Using the Phone Keypad	3-1
Smart Dialing	3-2
Using Contacts	3-3
Using Call Log	3-4
Answering a Call	3-4
Incoming Call Features	3-4
Missed Call Notification	3-4
Emergency Calling	3-5
Audio Modes	3-5
Using a Bluetooth Headset	3-5
Adjusting Audio Volume	3-5
Muting a Call	3-5
Using Call Log	3-6
Managing Call Log	3-6
Using the Call Log Menu	3-6

Conference Calling	3-7
Making a 3-Way Call	3-10
Voice Commander	3-10
Call	3-11
Find	3-11
Redial	3-12
Callback	3-12
Start	3-12
Appointments	3-12
Read	3-12
What time is it	3-13
Call History	3-13
Voice Play Music	3-13
What can I say	3-14
Goodbye	3-14

Chapter 4: Phone Network Setup

Introduction	4-1
Automatic Network Setup	4-1
Manual Network Setup	4-1
CDMA Network Setup	4-1
GSM Network Setup	4-2
Dual Network Usage	4-3
Global Usage	4-3
Configuring a GSM Data Connection	4-4
Phone Settings	4-4
Sounds	4-4
Security	4-5
Enabling a PIN	4-5
Changing a PIN	4-5
Disabling a PIN	4-5
GSM Services	4-6
Call Barring (Call Blocking)	4-6
Caller ID	4-6
Call Forwarding	4-6
Call Waiting	4-6
Voice Mail and Text Messages	4-7
Fixed Dialing	4-7
Internet	4-7
Broadcast Channels	4-7
TTY	4-7
HAC	4-8

Chapter 5: Using WLAN

Introduction	5-1
Fusion Overview	5-1
Wireless Zero Config Overview	5-2
Switching Between Fusion and WZC	5-2

Supported Applications	5-2
Fusion Setup	5-3
Wireless Zero Config Setup	5-6
More Information on WZC	5-7

Chapter 6: Messaging

Introduction	6-1
Email	6-1
Creating an Email Message	6-1
Viewing an Email Message	6-1
Replying to or Forwarding a Message	6-2
SMS Messaging	6-2
Sending a Text Message	6-2
Viewing Text Messages	6-2
Replying to an SMS Message	6-3
MMS Messaging	6-4
Creating and Sending MMS Messages	6-4
Viewing an MMS Message	6-5
Replying to an MMS Message	6-5
Blocking Incoming MMS Messages	6-5

Chapter 7: Data Capture

Introduction	7-1
Digital Camera Scanning	7-1
Data Wedge	7-2

Chapter 8: Using the Camera

Introduction	8-1
Taking Pictures	8-1
Camera Settings	8-3
Camera Menu Options	8-3
Size/Quality Settings	8-3
Panorama	8-4
Timer	8-4
Advanced	8-4
About	8-5
Recording Video	8-5
Video Settings	8-5
Video Menu Options	8-6
Quality	8-6
Format	8-6
Time/Date stamp	8-6
Storage	8-6
About	8-6
Viewing Pictures and Video	8-7
Albums	8-7
Select Mode	8-8

Thumbnail Menu	8-8
Gallery Menu	8-8
Image Viewer	8-8
Annotating Images	8-9
Audio Commenting	8-10
View or Edit Image Information	8-10
Image Menu	8-10
Video Viewer	8-10
View or Edit Video Information	8-11
Video Menu	8-11

Chapter 9: Bluetooth

Introduction	9-1
Adaptive Frequency Hopping	9-1
Security	9-2
Bluetooth Configuration	9-2
Bluetooth Power States	9-3
Suspend	9-3
Resume	9-3
Turning Bluetooth On and Off	9-3
Enabling Bluetooth	9-3
Disabling Bluetooth	9-4
Discovering Bluetooth Device(s)	9-4
Available Services	9-5
Object Push Services via Beam	9-6
Internet Sharing	9-7
Hands-free Services	9-7
Serial Port Services	9-8
ActiveSync Using Bluetooth	9-9
Phone Book Access Profile Services	9-10
Dial-Up Networking Services	9-11
Connect to a HID Device	9-11
A2DP/AVRCP Services	9-11

Chapter 10: Using GPS Navigation

Introduction	10-1
Software Installation	10-1
ES400 GPS Setup	10-1
Operation	10-2
GPS Maps on microSD Cards	10-2
Answering a Phone Call While Using GPS	10-2
Losing the GPS Signal While in a Vehicle	10-2
Assisted GPS	10-2

Chapter 11: Settings

Introduction	11-1
Settings Folder	11-1

Locking the ES400	11-3
Switching Between Microsoft Lock and Lock Plus	11-3
Lock Plus Setup	11-3
Password Locking	11-4
Finger Swipe Locking	11-4
Editing Fingerprint Swipes	11-5
Edit Lock Screen Display	11-6
Audio Feedback	11-6
Microsoft Locking	11-6
Password Locking Setup	11-7
Switching the Dialer	11-8
Device Management Window	11-8
Sound Profiles	11-8
Power Profiles	11-9
Alarms	11-10
Backlight and Keylight Settings	11-10
Accelerometer	11-11
Display Tab	11-11
About Tab	11-11
Optical Nav Pad	11-11
Key Remapping	11-12
Remap a Key to a Program	11-12
Remap a Key to a Character	11-12
Remap a Key to a Function	11-13
Remap a Key to a Character Using the Soft Keypad	11-13
Remap Simultaneous Keys	11-14
Editing a Remap Key	11-14
Master Reset	11-15
Program Shortcuts Setup	11-16
My Apps Window Setup	11-17
Card Setup	11-18
Re-Order Cards	11-18
Configure Cards	11-18
Weather Card Setup	11-19
Add a New Location	11-19
Change Location	11-19
Delete a Location	11-19
Time Tracker Setup	11-20
Email Setup	11-21
Setting Up an IMAP or POP Account	11-21
Automatic Email Setup	11-21
Manual Email Setup	11-22
Entering Email Settings Manually	11-22
Editing an Email Account	11-24
Setting Email Signatures	11-25
Using Microsoft ActiveSync With a Corporate Outlook Account	11-25
MMS Messaging	11-26
Voice Commander	11-27
Contacts Settings	11-27
Play	11-27

Voice Tag	11-27
Application Settings	11-28
Play	11-28
Voice Tag	11-28
Music Settings	11-29
Play	11-29
Voice Tag	11-29
Digit Trainer Settings	11-29
Digit Setting Settings	11-30
Advanced Settings	11-30

Chapter 12: Accessories

Introduction	12-1
USB Rapid Charge Cable	12-2
Single Slot USB Cradle	12-3
Charging the ES400 Battery	12-3
Communication with Host Computer	12-3
Vehicle Holder	12-5
Windshield Installation	12-5
Install the ES400	12-6
Connect Power	12-7
Remove the ES400	12-8
Host Adapter	12-9
Holster	12-10
ActiveSync	12-11
Installing ActiveSync	12-11
ES400 Setup	12-11
Setting Up an ActiveSync Connection on the Host Computer	12-11
Synchronization with the ES400	12-12

Chapter 13: Maintenance & Troubleshooting

Introduction	13-1
Maintaining the ES400	13-1
Battery Safety Guidelines	13-1
Cleaning	13-2
Materials Required	13-2
Cleaning the ES400	13-3
Housing	13-3
Display	13-3
Camera Window	13-3
Interface Connector	13-3
Battery Contacts	13-3
Cleaning Cradle Connectors	13-4
Cleaning Frequency	13-4
Troubleshooting	13-5
ES400	13-5
Bluetooth Connection	13-7
Single Slot USB Cradle	13-7

Vehicle Holder 13-8

Appendix A: Technical Specifications

ES400 Technical Specifications A-1
 ES400 A-1
 Headset A-5
 ES400 Accessory Specifications A-6
 Single Slot USB Cradle A-6

Appendix B: Keypads

Introduction B-1
 Special Character Key B-4

Appendix C: Windows Mobile Home Screen and Dialer

Introduction C-1
 Windows Mobile Home Screen C-1
 Classic Today Screen C-3
 Start Screen C-4
 Windows Mobile Dialer C-4
 Making a Call C-5
 Using the Phone Keypad C-5
 Smart Dialing C-5
 Using Contacts C-6
 Using Call History C-7
 Making a Speed Dial Call C-7
 Answering a Call C-8
 Incoming Call Features C-9
 Missed Call Notification C-9
 Emergency Calling C-9
 Muting a Call C-9
 Using Speed Dial C-10
 Adding a Speed Dial Entry C-10
 Editing a Speed Dial Entry C-11
 Deleting a Speed Dial Entry C-11
 Using Call History C-11
 Managing Call History C-12
 Changing the Call History View C-12
 Resetting the Recent Calls Counter C-12
 Deleting All Call History Items C-13
 Viewing Call Status C-13
 Using the Call History Menu C-13
 Swapping Calls (GSM) C-14
 Swapping Calls (CDMA) C-15
 Conference Calling (GSM) C-16
 Three-way Calling (CDMA) C-16

Appendix D: Software Installation

Installation Using ActiveSync	D-1
Installation Using Storage Card	D-1
Installation Using AirBEAM	D-2
MSP	D-2
Update Loader Image	D-2
Download Update Loader Package	D-2
ActiveSync	D-2
microSD Card	D-3

Glossary**Index**

About This Guide

Introduction

This guide provides information about using the ES400 Enterprise Digital Assistant (EDA) and accessories.

✓ **NOTE** Screens and windows pictured in this guide are samples and can differ from actual screens.

Documentation Set

The documentation set for the ES400 provides information for specific user needs, and includes:

- **ES400 Quick Start Guide** - describes how to get the ES400 up and running.
- **ES400 User Guide** - describes how to use the ES400.
- **Enterprise Mobility Developer Kit (EMDK) Help File** - provides API information for writing applications.

Configurations

This guide covers the following configurations:

Configuration	Radios	Display	Memory	Data Capture Options	Operating System	Keypads
ES400	WLAN: 802.11a/b/g WPAN: Bluetooth v2.0 WWAN: CDMA or GSM/UMTS GPS: Standalone GPS or A-GPS	3.0" VGA Color	256 MB RAM/ 1 GB Flash	3.2 MegaPixel color camera	Windows Mobile® 6.5 Professional	Alphanumeric keypads

Software Versions

This guide covers various software configurations and references are made to operating system or software versions for:

- Adaptation Kit Update (AKU) version
- OEM version
- Fusion software
- Phone software.

AKU Version

To determine the Adaptation Kit Update (AKU) version tap **Start > Settings > System > About > Version**.

The second line lists the operating system version and the build number. The last part of the build number represents the AKU number. For example, *Build 23103.5.3.6* indicates that the device is running AKU version 5.3.6.

OEM Version

To determine the OEM software version tap **Start > Settings > System > System Info > System**.



Platform Version

To determine the virtual platform version tap **Start > Settings > System > System Info > Package**.

Fusion Software

To determine the Fusion software version tap **Start > Wireless Companion > Wireless Status > Versions**.

Phone Software

To determine the Phone software version press  >  > **Phone information**.

Chapter Descriptions

Topics covered in this guide are as follows:

- [Chapter 1, Getting Started](#) provides information on getting the ES400 up and running for the first time.
- [Chapter 2, Using the ES400](#) provides information on using the ES400.
- [Chapter 3, Making Calls](#) provides basic instructions for using the ES400 phone.
- [Chapter 4, Phone Network Setup](#) provides information for setting up the ES400 on a network.
- [Chapter 5, Using WLAN](#) provides information for configuring the ES400 on a wireless network.
- [Chapter 6, Messaging](#) provides instructions for sending text and MMS messages.
- [Chapter 7, Data Capture](#) provides instructions for using the ES400 to capture data using the laser scanner, imager and camera.
- [Chapter 8, Using the Camera](#) provides instructions on taking photos and videos.

- [Chapter 9, Bluetooth](#) explains Bluetooth functionality on the ES400.
- [Chapter 10, Using GPS Navigation](#) provides information about GPS navigation with the ES400.
- [Chapter 11, Settings](#) provides information for configuring the ES400.
- [Chapter 12, Accessories](#) describes the available accessories and how to use them with the ES400.
- [Chapter 13, Maintenance & Troubleshooting](#) includes instructions on cleaning and storing the ES400, and provides troubleshooting solutions for potential problems during ES400 operation.
- [Appendix A, Technical Specifications](#) provides the technical specifications for the ES400.
- [Appendix B, Keypads](#) provides keypad layouts and operation.
- [Appendix C, Windows Mobile Home Screen and Dialer](#) provides information for using the Windows Mobile Home screen and dialer.
- [Appendix D, Software Installation](#) provides information for installing applications and operating system updates.

Notational Conventions

The following conventions are used in this document:

- “Enterprise Digital Assistant” refers to the Motorola ES400.
- *Italics* are used to highlight the following:
 - Chapters and sections in this and related documents
 - Icons on a screen.
- **Bold** text is used to highlight the following:
 - Dialog box, window, and screen names
 - Drop-down list and list box names
 - Check box and radio button names
 - Key names on a keypad
 - Button names on a screen.
- Bullets (•) indicate:
 - Action items
 - Lists of alternatives
 - Lists of required steps that are not necessarily sequential
- Sequential lists (e.g., those that describe step-by-step procedures) appear as numbered lists.

Related Documents

- *ES400 Quick Start Guide*, p/n 72-134310-xx.
- *ES400 Regulatory Guide*, p/n 72-134312-xx.
- *Mobility Services Platform User Guide*, p/n 72E-100158-xx.
- *Wireless Fusion Enterprise Mobility Suite User Guide for Version 3.20*, p/n 72E-135868-xx.

- AirBEAMSmart Windows CE Client Product Reference Guide, p/n 72-63060-xx.
- MSP Software User Guide, p/n 72E-100158-xx.
- *Enterprise Mobility Developer Kits (EMDKs)*, available at: <http://supportcentral.motorola.com>.
- Latest ActiveSync software, available at: <http://www.microsoft.com>.

For the latest version of this guide and all guides, go to: <http://supportcentral.motorola.com>.

Service Information

If you have a problem with your equipment, contact Motorola Enterprise Mobility support for your region. Contact information is available at: <http://www.motorola.com/enterprisemobility/contactsupport>.

When contacting Enterprise Mobility support, please have the following information available:

- Serial number of the unit (found on manufacturing label)
- Model number or product name (found on manufacturing label)
- Software type and version number.

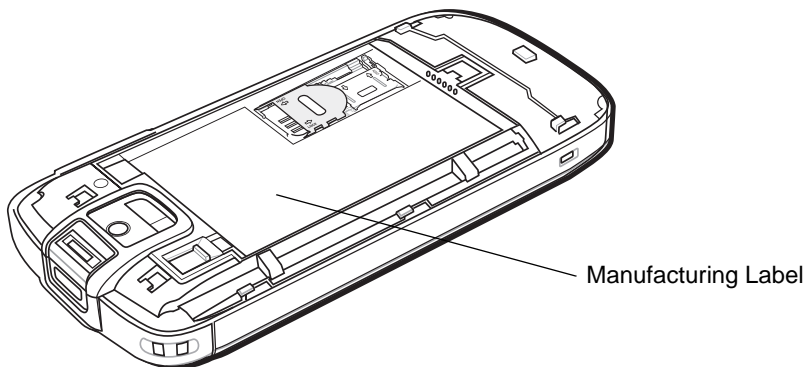

Motorola responds to calls by email, telephone or fax within the time limits set forth in support agreements.

If your problem cannot be solved by Motorola Enterprise Mobility Support, you may need to return your equipment for servicing and will be given specific directions. Motorola is not responsible for any damages incurred during shipment if the approved shipping container is not used. Shipping the units improperly can possibly void the warranty. Remove microSD card or SIM card prior to shipping.

If you purchased your Enterprise Mobility business product from a Motorola business partner, contact that business partner for support.

Chapter 1 Getting Started

Unpacking

Carefully remove all protective material from the ES400 and save the shipping container for later storage and shipping.

Verify that the following were received:

- ES400 Enterprise Digital Assistant with battery cover and stylus
- Lithium-ion battery (1540 mAh or 3080 mAh)
- USB Rapid Charge Cable
- Power Supply
- Country-specific plugs
- Tether
- Regulatory Guide
- Quick Start Guide.

Inspect the equipment for damage. If any equipment is missing or damaged, contact the Motorola Enterprise Mobility Support center immediately. See [page xviii](#) for contact information.

Prior to using the ES400 for the first time, remove the protective shipping film that covers the display and camera window.

Setting Up the ES400

To start using the ES400 for the first time:

- Remove the battery cover
- Install a microSD card (optional)
- Install a SIM card (GSM only)
- Install the battery.
- Powering on the ES400 for the First Time
- Charge the ES400.

Remove the Battery Cover

To remove the battery cover:

1. Hold the ES400 firmly in two hands as shown.
2. With thumbs, push the battery cover toward the bottom of ES400.
3. Lift the battery cover off the ES400.

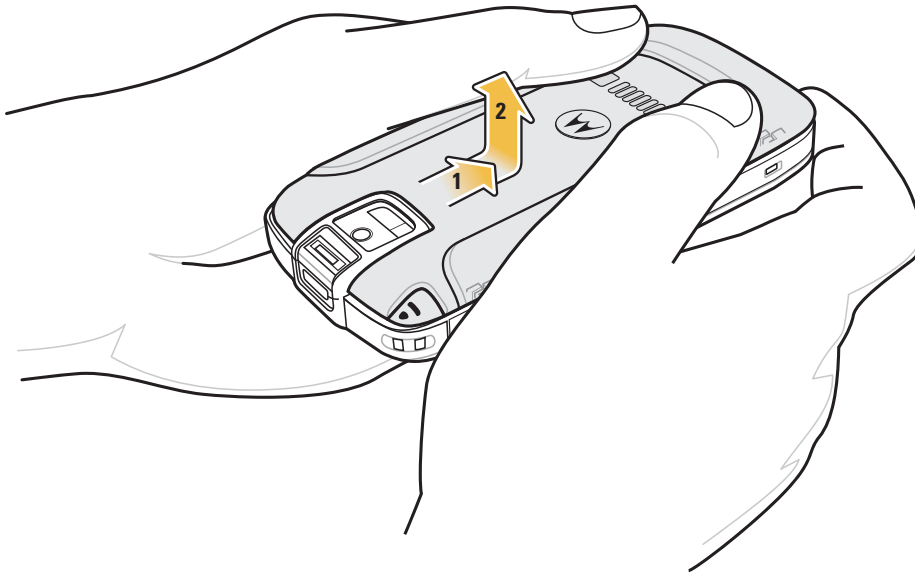

Figure 1-1 Battery Cover Removal

Installing a microSD Card

The microSD card slot, located under the battery, provides secondary non-volatile storage. Refer to the documentation provided with the card for more information, and follow the manufacturer's recommendations for use.



CAUTION Follow proper ESD precautions to avoid damaging the microSD card. Proper ESD precautions include, but are not limited to, working on an ESD mat and ensuring that the operator is properly grounded.

To install the microSD card:

1. Slide the SIM card holder up to unlock.
2. Lift the SIM card holder.

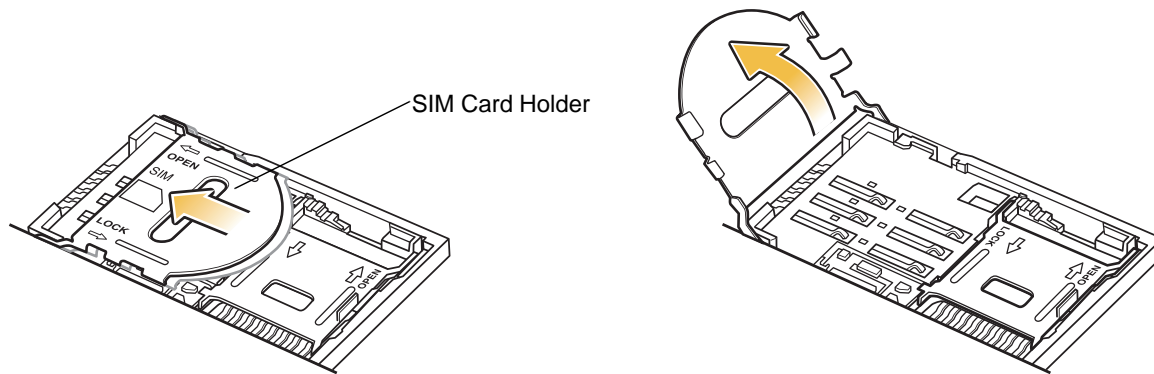

Figure 1-2 Open SIM Holder

3. Slide the microSD card holder to the right to unlock.
4. Lift the microSD card holder.

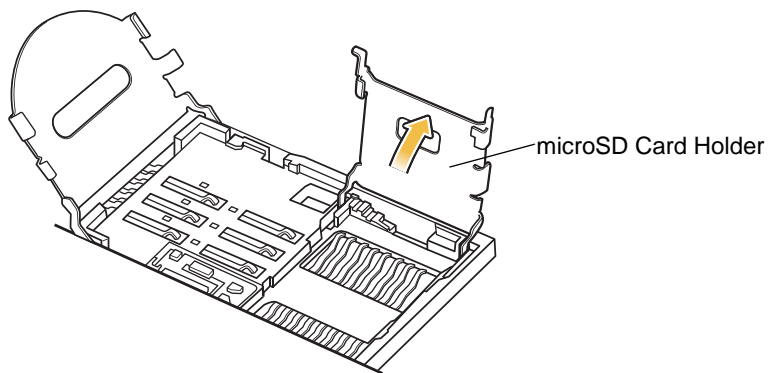

Figure 1-3 Open microSD Card Holder

5. Insert the microSD card into the holder.

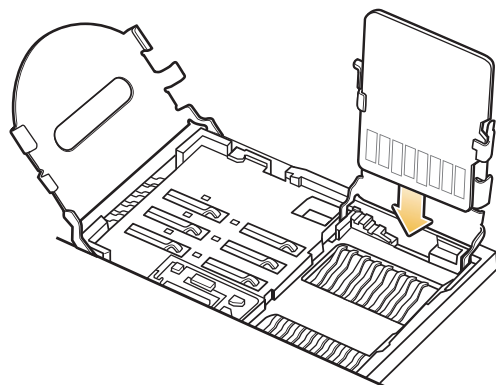

Figure 1-4 Insert microSD Card

6. Close the microSD card holder.

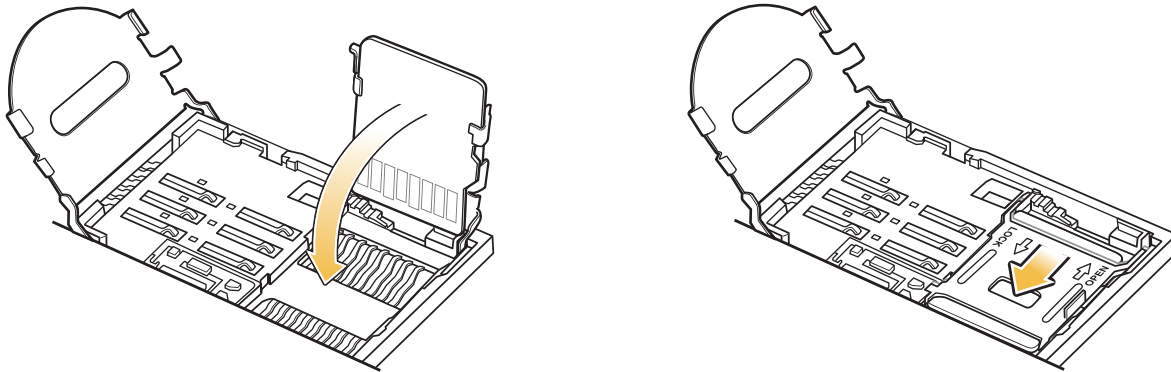

Figure 1-5 Close and Lock microSD Card Holder

7. Slide the microSD card holder to the left to lock.
8. If installing a SIM card, follow instructions in the next section.
9. If not installing a SIM card, close the SIM holder and slide down to lock into place and then install the battery.

Installing the SIM Card (GSM Only)

GSM phone service requires a Subscriber Identification Module (SIM) card. Obtain the card from the service provider. The card can contain the following information:

- Mobile phone service provider account details.
- Information regarding service access and preferences.
- Contact information, which can be moved to Contacts on the ES400.
- Any additional subscribed services.

✓ **NOTE** For more information about SIM cards, refer to the service provider's documentation.

To install the SIM card:

1. Insert the SIM card into the SIM card holder with the contacts facing out and the card notch facing up.

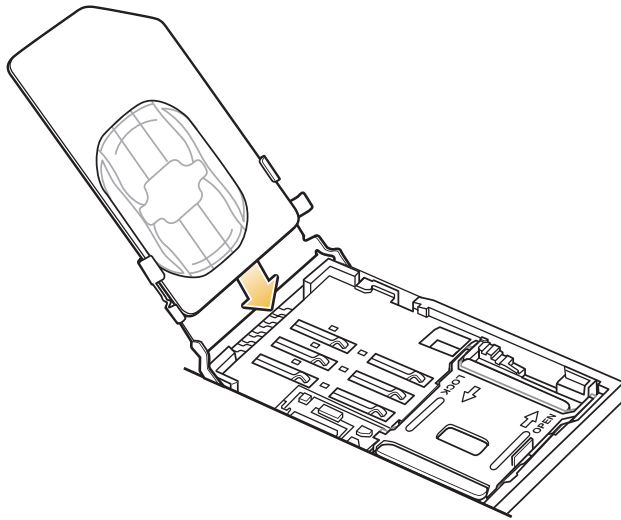

Figure 1-6 *Insert SIM Card*

2. Close the SIM card holder and slide down to lock into place. Ensure that the SIM card is fully inserted and lying flat. Ensure that the end of the card is not laying on top of the SIM Card tab.

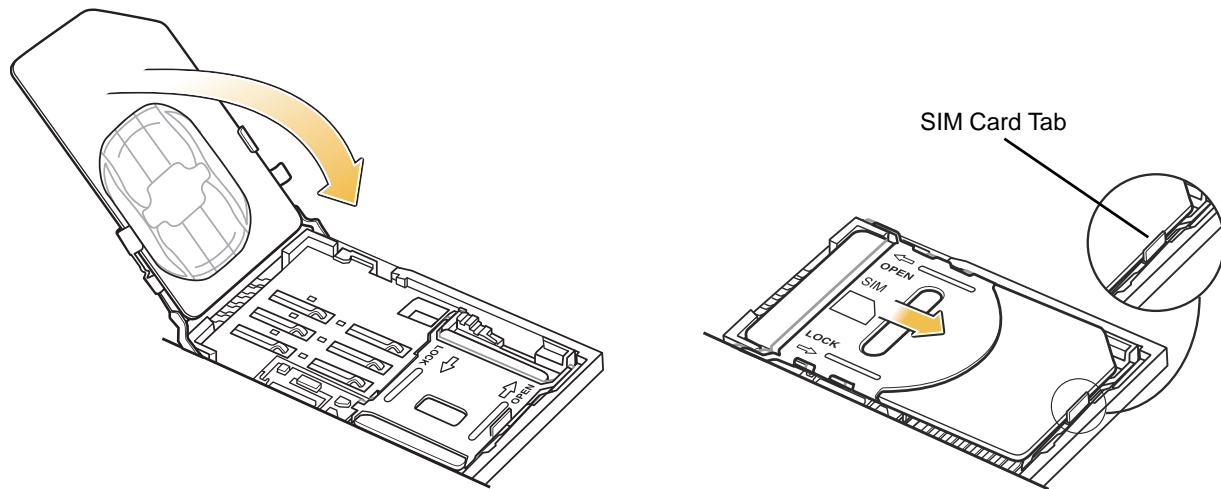

Figure 1-7 *Close and Lock SIM Card Holder*

Installing the Battery

To install the battery:

1. Locate the battery contacts.
2. Insert the battery, bottom first, into the battery compartment.
3. Press the battery down into the battery compartment.
4. Slide the battery lock latch down to secure the battery in place.

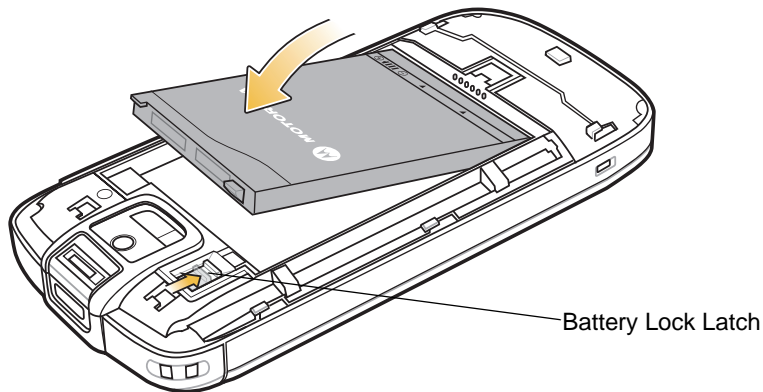

Figure 1-8 *Inserting the Battery*

5. Align the battery cover with device.

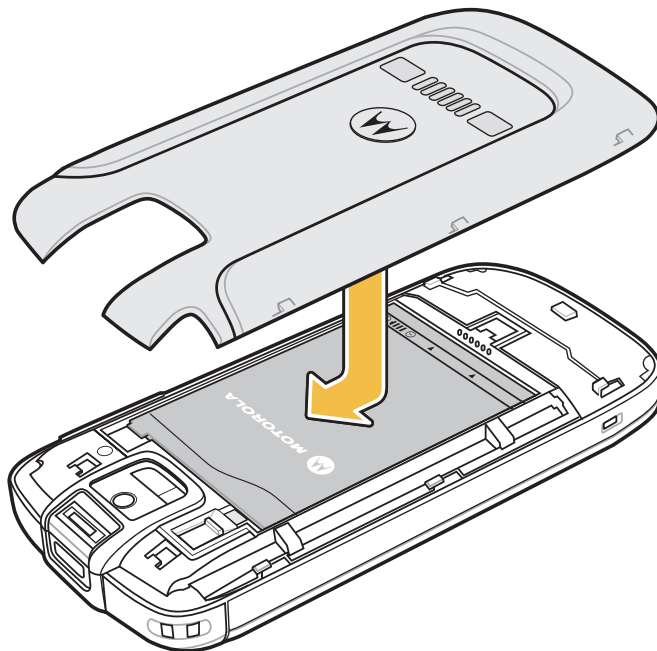

Figure 1-9 *Replacing the Battery Cover*

6. Slide the battery cover up to lock into place.

Powering On the ES400 for the First Time

Press the Power button to turn on the ES400. The splash screen displays as the ES400 boots then the calibration window appears.

- ✓ **NOTE** The Calibration screen can be accessed by tapping **Start > Settings > System > Screen > Align Screen** button.

1. Remove the stylus from the back of the ES400.
2. Tap the screen to begin calibration.
3. Carefully press and briefly hold the tip of stylus on the center of each target that appears on the screen.

4. Repeat as the target moves around the screen.
5. Follow the on-screen instructions to set the date and time, and then email and password. Once completed ES400 displays the Home screen.

Network Activation

To activate on a GSM/UMTS network:

1. If an active SIM card was installed in the ES400, the ES400 performs the activation process.
2. The **Phone Network - GSM/UMTS Setup** dialog box displays.
3. Tap **Yes** and then **OK**. For some carriers, the ES400 resets.
4. If during start-up, no update connection settings message appears, tap **Start > Settings > Connection > Phone Network Setup** and tap **Update Connection Settings** button.
5. If the network is unsupported, a message appears with links for manually setting the data connection and MMS settings.

To activate on a CDMA network:

1. Create an account with the CDMA carrier. Provide the MEID number (located on the back of the ES400 or tap **Start > Settings > System Display Info**) to the customer service representative.
2. If a SIM card was not installed, a **No SIM card found** dialog box displays.
3. Tap **OK**. The **Phone Network - CDMA Activation** dialog box displays.
4. Tap **Yes** to activate on a CDMA network.
5. On the **CDMA Setup** tab, tap the **Preferred network** option and select a network.
6. Tap **Yes**.
7. Tap the **Start Activation** button.
8. Tap **Yes** to activate.
9. Press **Activate Now** button.

For detailed information for configuring the phone and activating on a different network, see [Chapter 4, Phone Network Setup](#).

Power Off the ES400

To power off the ES400, press and hold the Power button for at least five seconds.

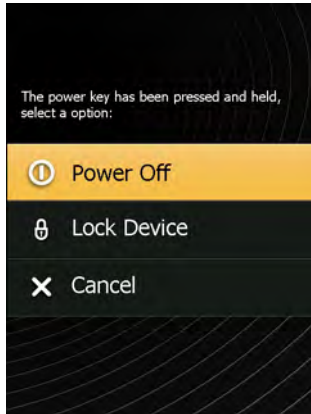

Figure 1-10 *Shutdown Window*

Select **Power Off** to shutdown the ES400.

Suspend

ES400 goes into suspend mode when any of the following occur:

- User presses and releases the Power button
- User places the ES400 into the optional holster
- Power timeout
- Battery reaching a critical low value.

ES400 wakes from suspend when one of the following occurs:

- User presses the Power button
- ES400 receives an incoming call or data
- Bluetooth event occurs
- User inserts a USB device into the microUSB port
- User places the ES400 in the cradle
- User connects or removes a headset to or from the audio port.
- User removes the ES400 from the optional holster.

Removing the microSD Card

To remove an microSD card:



CAUTION Save all data before removing the battery. Failure to do so may cause potential loss of data.

1. Press the **Power** button to suspend the ES400.
2. Slide the battery cover toward the bottom of the device.
3. Remove the battery cover.
4. Slide the battery lock latch up.
5. Lift the battery out of the ES400.
6. Slide the SIM card holder up to unlock.
7. Lift the SIM card holder.
8. Slide the microSD card holder to the right to unlock.
9. Lift the microSD card holder.
10. Remove microSD card from holder.
11. Close the microSD card holder.
12. Slide the microSD card holder door to the left to lock.
13. Close the SIM card holder.
14. Slide the SIM card holder down to lock.
15. Replace the battery.
16. Slide the battery lock latch down to lock the battery in place.
17. Replace the battery cover.

Removing the SIM Card

To remove an SIM card:



CAUTION Save all data before removing the battery. Failure to do so may cause potential loss of data.

1. Press the **Power** button to suspend the ES400.
2. Slide the battery cover toward the bottom of the device.
3. Lift the battery cover.
4. Slide the battery lock latch up.
5. Lift the battery out of the ES400.

6. Slide the SIM card holder up to unlock.
7. Lift the SIM card holder.
8. Remove the SIM card from holder.
9. Close the SIM card holder.
10. Slide the SIM card holder to the down to lock into place.
11. Slide the battery lock latch down to lock the battery in place.
12. Replace the battery cover.

Installing the Tether

The ES400 comes with an optional tether to secure the stylus to the ES400.

1. Remove the stylus from the back of the device.
2. Feed one loop of the tether through the stylus (1), and pass the other loop through the first (2).
3. With the stylus secured to the tether, feed the free loop through the tether anchor and pass the stylus through the loop (3) to secure it.

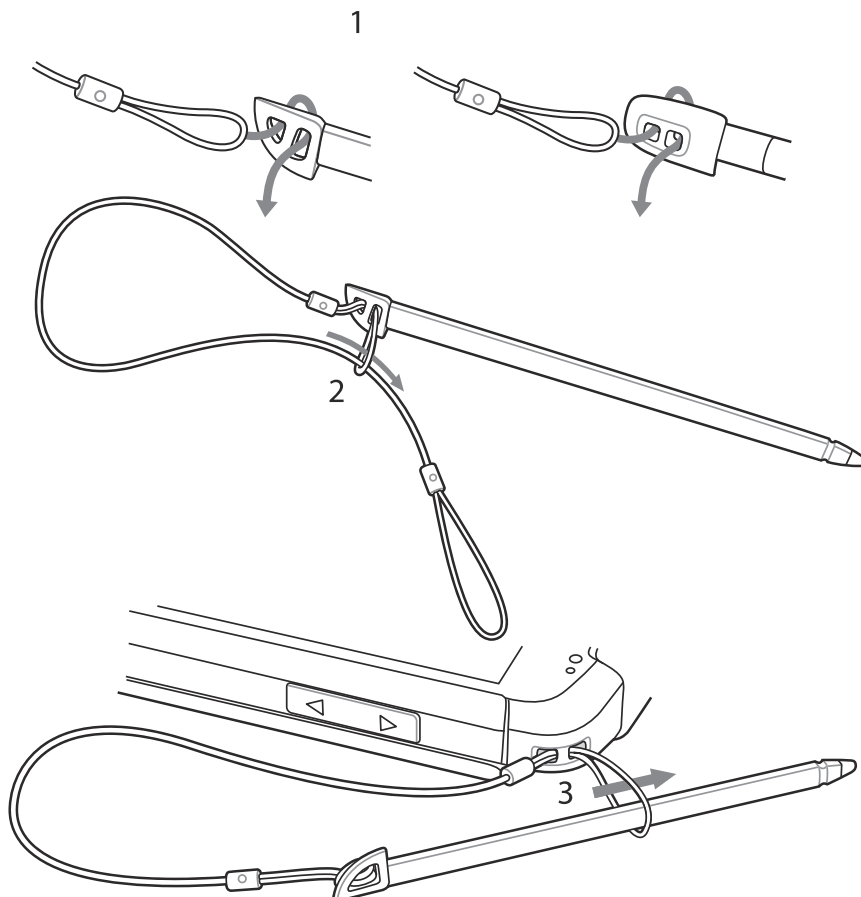

Figure 1-11 *Install Tether onto Stylus and ES400*

Chapter 2 Using the ES400

Introduction

This chapter explains the indicators, buttons, status icons, and controls on the ES400, and provides basic instructions for using the device.

Features

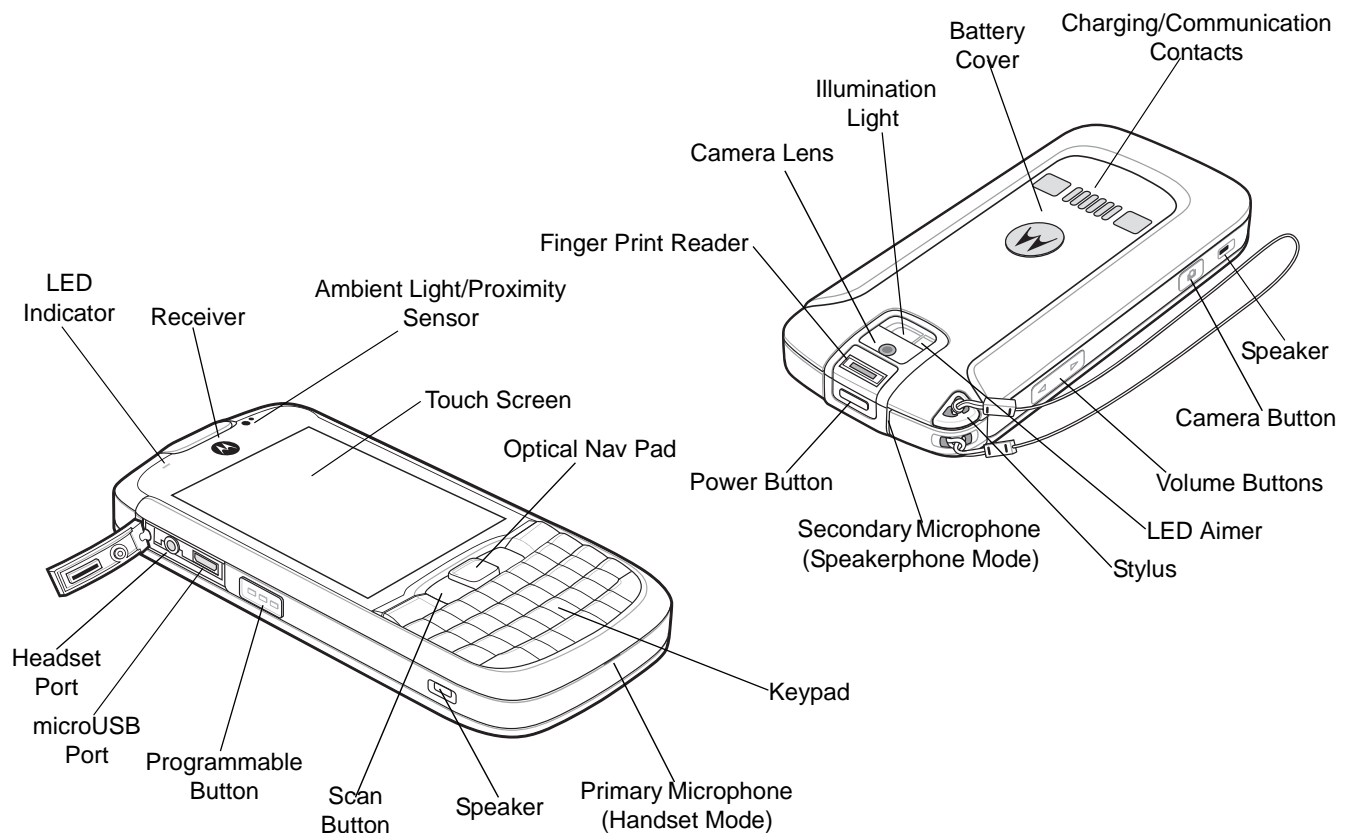

Figure 2-1 ES400 Features

Keypads

The ES400 comes in three keypad configurations; QWERTY, QWERTZ and AZERTY. Refer to [Appendix B, Keypads](#) for detailed information on the keypad configurations.



Figure 2-2 QWERTY Keypad

Special Characters

To add special characters, press and hold a key until the available special characters appear on the display. Tap the special character. [Table B-2 on page B-4](#) lists the available special characters.

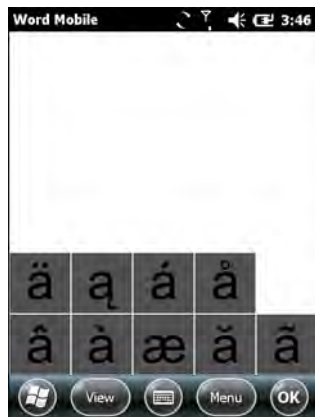



Figure 2-3 Special Character Display

Also press  +  to display additional characters. Tap the special character to select.

Keypad Remapping

The user has the ability to remap the keypad keys to characters or applications. Refer to [Chapter 11, Settings](#) for detailed information on remap keypad keys.

Entering Data

When entering data on the keypad, use either the single-hand method or the two-hand method as shown in [Figure 2-4](#).

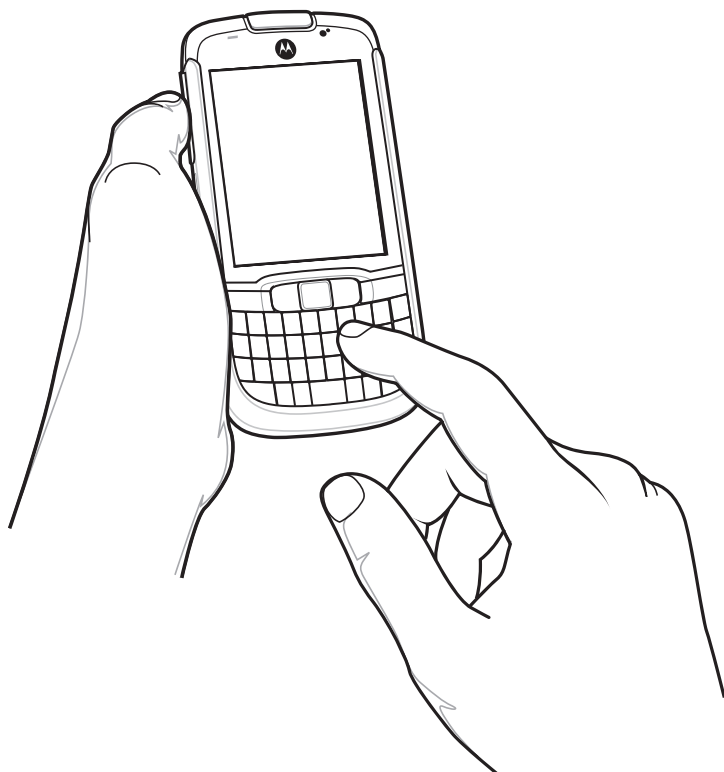

Single-hand Method

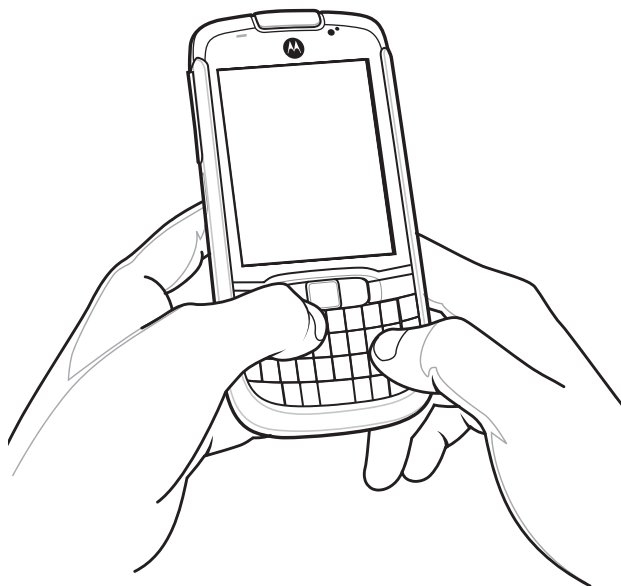



Two-hand Method



Figure 2-4 *Entering Data on the Keypad*

Screen Navigation

✓ **NOTE** To change the default Optical Nav Pad settings and sensitivity tap **Start > Settings > Personal > Nav pad**.

The optical nav pad on the keypad provides the ability to navigate on the screen using either 4-way navigation or a mouse cursor.

To switch between the 4-way navigation and the mouse cursor, press  +  or hold the  for three seconds.

 appears briefly when the 4-way navigation is enabled and  appears briefly when mouse cursor is enabled.

With 4-way navigation, the user moves their thumb across the optical nav pad and moves the highlight object on the screen.

With the mouse cursor, the user moves the cursor around the screen like on a PC.

Press the optical nav pad to select items on the screen, similar to a mouse click.

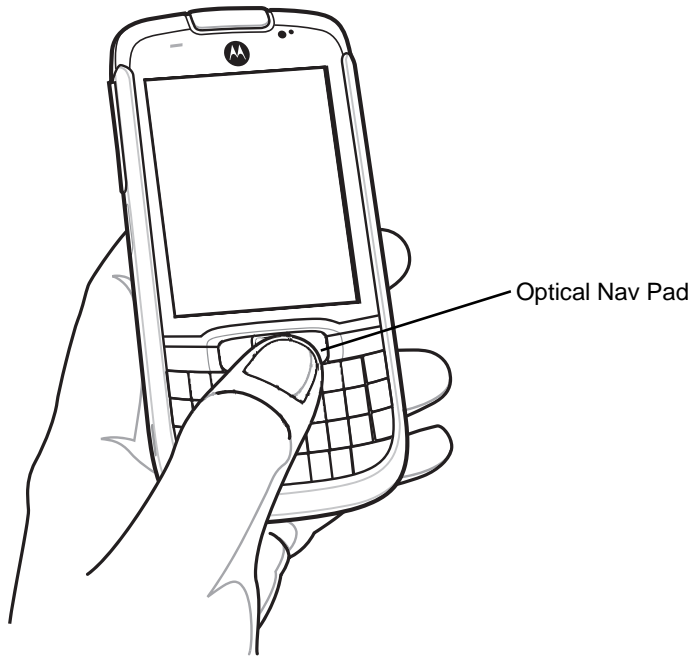

Figure 2-5 *Using the Optical Nav Pad*

Finger Scrolling

Finger scrolling can be used to scroll up and down web pages, documents, and lists such as the contacts list, file list, message list, calendar appointments list, etc.

When finger scrolling, swipe or flick your finger on the screen.

To scroll down, swipe your finger upward on the screen. To scroll up, swipe your finger downward on the screen.

Motorola Home Screen

The customizable Motorola Home screen provides faster and easier access to features and applications, and allows users to tailor the interface to improve their unique workflow and maximize on-the-job efficiency.

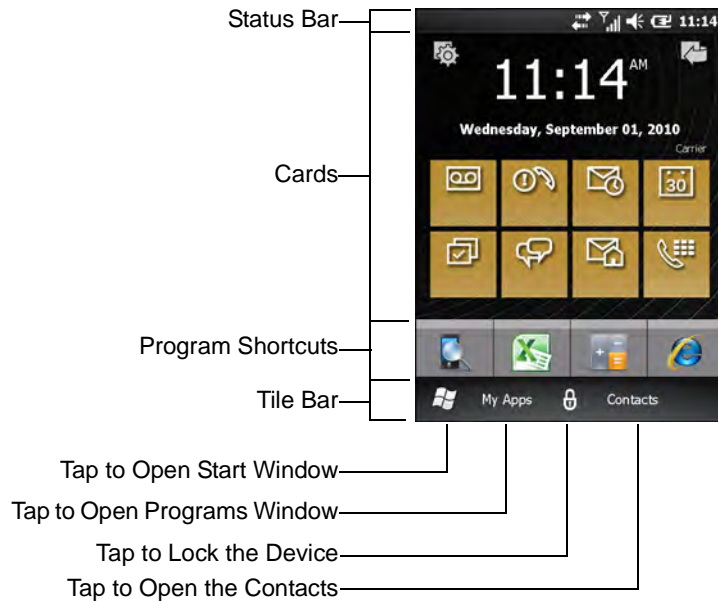

Figure 2-6 Motorola Home Screen

Status Bar

The **Status Bar** at the top of the screen displays the status icons listed in [Table 2-1](#). Tap anywhere on the **Status Bar** to open the **Device Management** window. Refer to [Device Management on page 2-13](#) for more information.

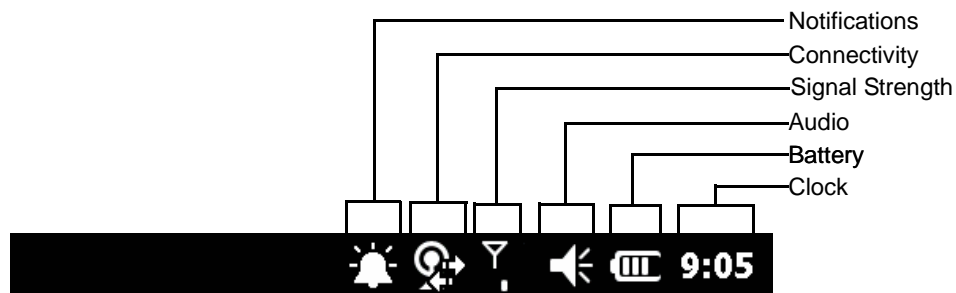

Figure 2-7 Status Bar Icons

To view notifications, tap the Status Bar and select . See [Status on page 2-18](#) for more information.

Table 2-1 Status Bar Icons



























































Icon	Description	Icon	Description
Notifications			
	Reminder of an upcoming calendar event.		One or more instant messages were received.
	One or more text messages were received.		One or more voice messages were received.
	There are more notification icons than can be displayed.		Bluetooth is on.
	One or more Email messages were received.		Receiving MMS message.
	Sending MMS message.		MMS message sent successfully.
	MMS message received successfully.		TTY Headset enabled.
	TTY HCO enabled.		TTY VCO enabled.
	Microsoft customer feedback alert.		
Connectivity			
	Connection is active.		Connection is not active.
	Synchronization is occurring.		Wi-Fi available.
	Wi-Fi in use.		HSDPA available. (GSM only)
	3G available. (GSM only)		GPRS available. (GSM only)
	EGPRS available. (GSM only)		1xRTT available. (CDMA only)
	EVDO Rev. 0 available. (CDMA only)		EVDO Rev. A available. (CDMA only)
	Dormant State - no data transmission during a 1x or EVDO connection. (CDMA only)		Roaming.
WAN			
	Call missed.		Dialing while no SIM card is installed.
	Voice call in progress.		Calls are forwarded.
	Call on hold.		Speakerphone is on.
	Wan on/good signal.		Phone is off.
	No WAN service.		Searching for WAN service.
	HSDPA in use. (GSM only)		HSDPA connecting. (GSM only)
	3G in use. (GSM only)		3G connecting. (GSM only)

Table 2-1 Status Bar Icons (Continued)

Icon	Description	Icon	Description
	GPRS in use. (GSM only)		GPRS connecting. (GSM only)
	EGPRS in use. (GSM only)		EGPRS connecting. (GSM only)
	EVDO in use. (CDMA only)		EVDO connecting. (CDMA only)
	SIM Card not installed. (GSM only)		
Audio			
	All sounds are on.		All sounds are off.
	Vibrate is on.		
Battery			
	Battery is charging.		Battery has a full charge.
	Battery has a high charge.		Battery has a medium charge.
	Battery has a low charge.		Battery has a very low charge.

Cards

Cards provide quick access to completing common tasks. The number and type of cards available to an end user are configurable by the system administrator or the end user. By default, the ES400 ships with four cards.

Swipe finger left or right on the screen to view adjacent cards.

Cards can be rearranged, deleted or added to the Home screen. See [Chapter 11, Settings](#) for more information.

Simple Home Card

The Simple Home card displays the current date and time and notifications.

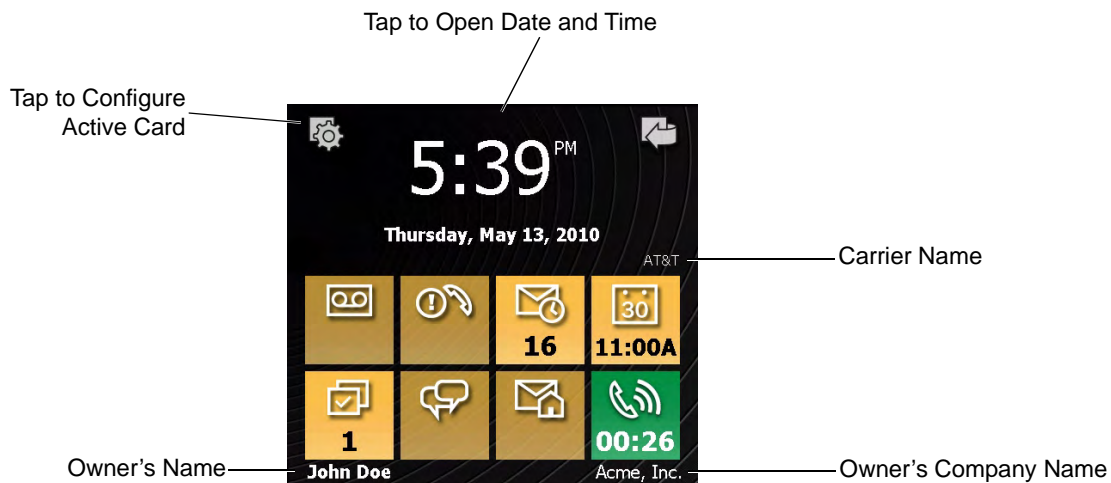

Figure 2-8 Simple Home Card

Full Home Card

The Full Home card displays the current date and time and notifications with expanded information.

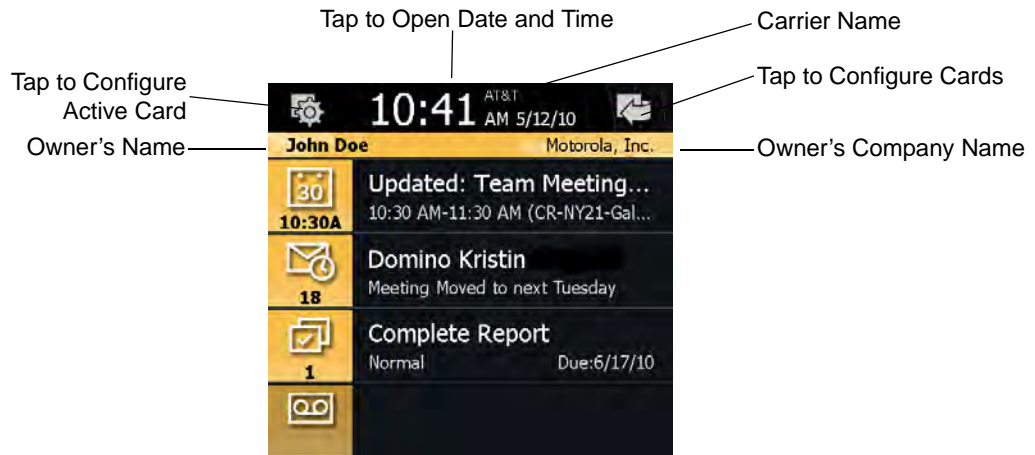

Figure 2-9 Full Home Card

Table 2-2 lists the Home card shortcut icons.

Table 2-2 Home Card Icons

Icon	Description
	Calendar: Indicates the next appointment in the calendar. Tap to open the Calendar application.
	Corp Email: Indicates the number of unread emails in Outlook email. Tap to open the Outlook application.
	Tasks: Indicates the number of unfinished tasks. Tap to open the Task application.
	Messages: Indicates the number of unread SMS and MMS messages. Tap to open the Messaging application.
	Voicemail: Indicates the number of voice messages in the voicemail box.
	Missed Calls: Indicates the number of missed call.
	Home Email: Indicates the number of unread emails in a personal email account. Tap to open the Messaging application.
	In Call Status: Indicates call status. Tap to open the Phone dialer.

Weather Card

The **Weather** card display the weather for a selected city.



Figure 2-10 Weather Card

See to [Weather Card Setup on page 11-19](#) for information on configuring the Weather card.

Time Tracker Card

The **Time Tracker** card provide a easy way for a worker to log hours spend at a job and output this information in a easy to use format.

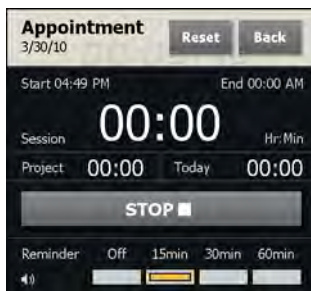

Figure 2-11 Time Tracker Card

See to [Time Tracker Setup on page 11-20](#) for information on configuring the Weather card.

Program Shortcuts

The Program Shortcut buttons provides easy access for four often used applications. Just tap the icon to launch the application. To configure the Program Shortcuts refer to [Program Shortcuts Setup on page 11-16](#).



Figure 2-12 My Apps Window

My Apps Window

The **My Apps** window provides access to all the applications on the ES400. The window is configurable so that it can display favorite applications. To configure the **My Apps** window refer to [My Apps Window Setup on page 11-17](#).

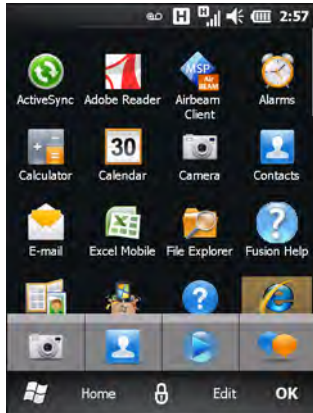

Figure 2-13 My Apps Window

My Apps screen is configurable. See [My Apps Window Setup on page 11-17](#) for more information.

Tile Bar

The **Tile Bar**, located at the bottom of the screen, contains the **Start** tile  to open the **Start Menu**. It also displays tiles that vary depending upon the open application.



Figure 2-14 Tile Bar Examples

Table 2-3 Programs Available on the Start Menu









Icon	Description	Icon	Description
	ActiveSync - Synchronize information between the ES400 and a host computer or the Exchange Server.		AirBEAM Client - Allows legacy customers to deploy AirBEAM Smart™ packages to devices.
	Alarms - Set the clock to the date and time of your locale. Alarms can also be set at specified days and times of a week.		Bing - Search the internet.
	Calculator - Perform basic arithmetic and calculations, such as addition, subtraction, multiplication, and division.		Calendar - Keep track of appointments and create meeting requests.
	Contacts - Keep track of friends and colleagues.		E-mail - Send an Email.

Table 2-3 Programs Available on the Start Menu





























Icon	Description	Icon	Description
	File Explorer - Organize and manage files on the device.		Games - Play games.
	Getting Started - Launch the Getting Started application.		Help - Access on-line Help topics.
	Home: Display the Home screen.		Internet Explorer - Browse Web and WAP sites as well as download new programs and files from the Internet.
	Internet Sharing - Connect a notebook computer to the Internet using the ES400's data connection.		Marketplace - Purchase applications from the Marketplace.
	Messenger - Use the mobile version of Windows Live Messenger.		Microsoft My Phone - Synchronizes the ES400's contacts, calendar, tasks, text messages, music, photos videos and documents with a Microsoft My Phone account.
	MSN Money - Keep track of finances.		MSN Weather - Check the local weather.
	MSP Agent - Enables management of the ES400 from an MSP Server. Requires the purchase of an appropriate MSP client license per device to suit the level of management functionality required.		Notes - Create handwritten or typed notes, drawings, and voice recordings.
	Office Mobile 2010 - Provides access to Excel Mobile, PowerPoint Mobile, OneNote Mobile, SharePoint WorkSpace Mobile and Word Mobile applications.		Phone - Make calls.
	Pictures & Videos - View and manage pictures, animated GIFs, and video files.		Rapid Deployment Client - Allows the ES400 user to stage a device for initial use by initiating the deployment of settings, firmware, and software. Requires the purchase of an MSP client license per device.
	Remote Desktop Mobile - Log onto Windows NT server type computers and use all of the programs that are available on that computer from the ES400.		Search Phone - Search contacts, data, and other information on the ES400. Refer to the Microsoft Applications for Windows Mobile 6 User Guide for more information.
	Settings - Opens the Settings folder. See Settings Folder on page 11-1 for more information.		SMS Staging - Receives and processes SMS messages from an MSP Server and allows the user to stage an ES400 based on them. Requires the purchase of an MSP client license per device.

Table 2-3 *Programs Available on the Start Menu*

Icon	Description	Icon	Description
	Task Manager - Enables viewing of memory and CPU allocations and stops running processes.		Tasks - Keep track of tasks.
	Text - Send an SMS or MMS message.		Toolbox - Contains the Adobe Reader and Voice Commander applications.
	Wireless Companion - Opens the Wireless Companion folder.		Windows Live - Use the mobile version of Windows Live™ to find information on the web.
	Windows Media - Play back audio and video files.		

Device Management

The **Device Management** window provides quick access to information and settings for the ES400.

Tap anywhere on the **Status Bar** to open the **Device Management** window.

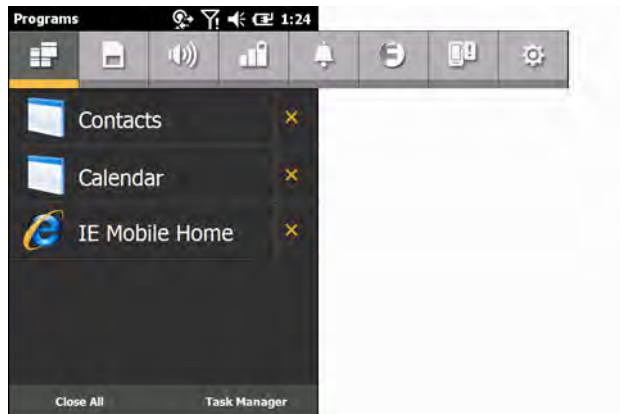





Figure 2-15 *Device Management Window*

The navigation bar consists of eight tabs:

- Programs 
- Memory Manager 
- Sound Profiles 
- Power & Radio 
- Alarms 
- Fusion 
- Status 
- Settings 

Tap an icon to open the associated tab. Scroll left or right to view more icons.

Programs

The **Programs** tab lists the programs that are currently running on the ES400 and allows for easy program switching, and a quick way to end processes.

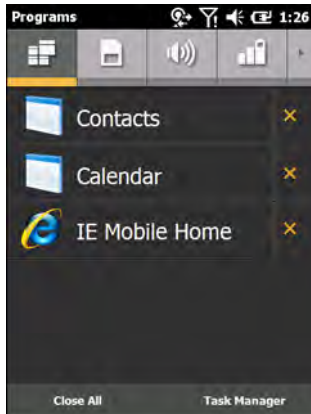

Figure 2-16 *Programs Tab*

- To switch to a program, tap the name of the program.
- To end a running program, tap the X next to the program name.
- To close all running programs, tap **Close All**.
- To go to the **Task Manager** application, tap **Task Manager**.

Memory Manager

The **Memory Manager** tab displays an overview of memory utilization, and a quick way to free up space.

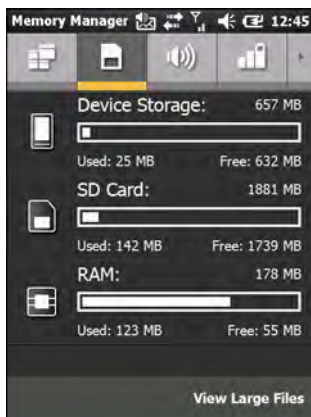

Figure 2-17 *Memory Manager Tab*

- Device Storage - Lists the total available Flash and the amount of Flash that is currently being used.
- SD Card - Lists the total available memory and the amount of memory that is currently being used.
- RAM - Lists the total available RAM and the amount of RAM that is currently being used.

Tap **View Large Files** to display files on the ES400 that are above a specific byte size.

Sound Profiles

The **Sound Profiles** tab provides direct access to sound-related profiles.



Figure 2-18 Sound Profiles Tab

To select a profile, tap the profile name.

- **Vibrate** - Ring type, reminder and notifications are set to vibrate. Ring and system volumes are set to 0 (off).
- **Silent** - Ring type, reminder and notifications are set to None. Ring and system volumes are set to 0 (off).
- **Schedule** - Ring type, reminder and notifications are set to vibrate when Calendar meeting is in session.
- **Normal** - Ring type is set to Ring, Reminder is set to Vibrate & Sound, Notification is set to Play Sound. Ring and system volumes are set to level 4.
- **Loud** - Ring type is set to Vibrate & Ring, Reminder is set to Vibrate & Sound, Notification is set to Vibrate & Sound. Ring and system volumes are set to level 5.
- **Ambient** - Profile settings are set based on the surrounding environment's sound level.

The **Temporary** profile is created when changes are made by the system, for example: the user adjust the volume using the volume buttons.

Refer to [Sound Profiles on page 11-8](#) for information on creating new sound profiles.

Power & Radio

The **Power & Radio** tab displays the current battery status and direct access to power profiles and power/radio-related options.

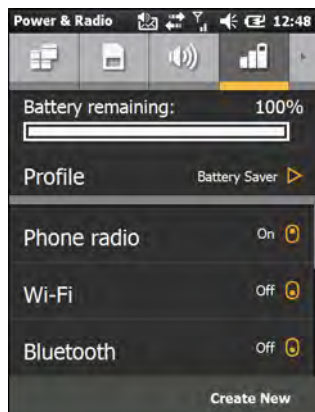

Figure 2-19 Power & Radio Tab

The **Battery remaining** graphic displays the amount of battery power remaining in the form of a bar graph and also as a percentage.

The Profile row displays the current profile that is being used. To set a defined profile, tap **Profile**. A list of profiles appear. Select a profile from the list. A radio button appears next to the selected profile. To view the properties of a profile in the list, tap **>** next to the profile.

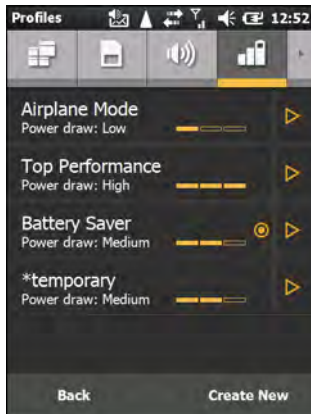

Figure 2-20 Power Profiles Page

Tap **Back** to return to the **Profiles** tab.

The user can manually change the following settings (slide the display up to view more options).

- **Phone radio** - Turns the phone radio on or off.
- **Wi-Fi** - Turns the Wi-Fi radio on or off.
- **Bluetooth** - Turns the Bluetooth radio on or off.
- **Device timeout** - Sets the amount of time after inactivity that the ES400 goes into suspend mode.
- **Backlight** - Sets the amount of time after inactivity that the ES400 backlight turns off.
- **Brightness** - Sets the display brightness.
- **ActiveSync Peak time** - Sets the interval between which the ES400 checks for email and calendar events during peak time.
- **ActiveSync Off-peak time** - Sets the interval between which the ES400 checks for email and calendar events during off-peak time.

Refer to [Power Profiles on page 11-9](#) for information on creating new profiles.

Alarms

The **Alarms** tab controls the Windows Mobile enabled alarms.

Tap Status Bar > .

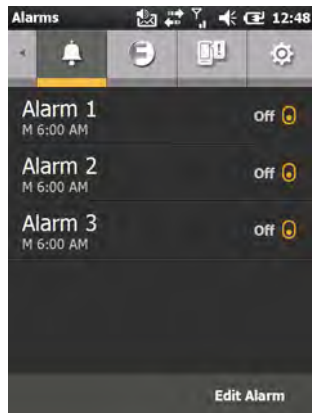

Figure 2-21 *Alarms Tab*

To turn an alarm on or off tap the alarm name.

To change an alarm setting, tap **Edit Alarm**.

Refer to [Alarms on page 11-10](#) for information on configuring the alarms.

Fusion

The **Fusion** tab provides access to the Fusion interface.

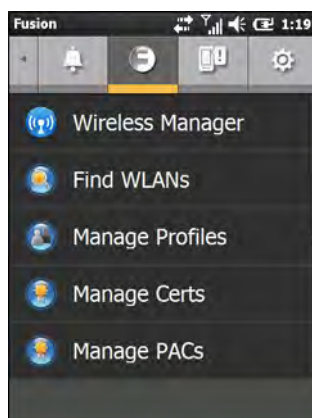



Figure 2-22 *Fusion Tab*

Refer to [Chapter 5, Using WLAN](#) for information on using and setting up a WLAN.

Status

The **Status** tab displays all system notifications. The ES400 notifies the user of system information by displaying icons on the Status bar, see Notification icon list in [Table 2-1 on page 2-6](#). Tap the Status bar and select .

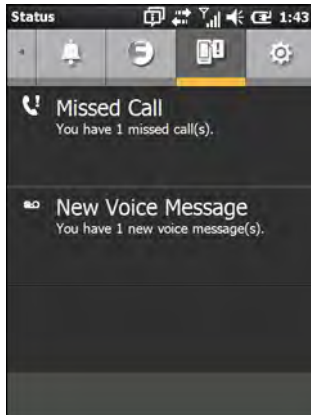

Figure 2-23 Status Tab

Tap a notification to read the associated information.

Settings

The **Settings** tab lists the settings applications on the ES400. Tap an item in the list to open the associated setting application or folder. Slide the list up to view more settings icons.

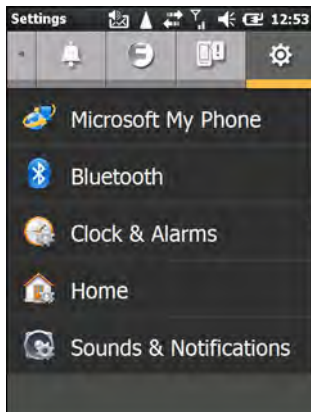

Figure 2-24 Settings Tab

Refer to [Table 11-1 on page 11-1](#) for a list of setting application icons and their descriptions.

Adjusting Volume

To adjust the system volume:

1. Press the volume buttons on the right side of the ES400 to increase and decrease the system volume. The **Volume** dialog box appears.
2. As you increase or decrease the volume, the slider moves accordingly. You can also move the slider to adjust the volume.
3. Select the **Vibrate** radio button to turn off the system audio and enable the ES400 to vibrate upon system notifications.
4. Select **Off** radio button to turn off all system audio notifications.

Charging the ES400



CAUTION Ensure that you follow the guidelines for battery safety described in [Battery Safety Guidelines on page 13-1](#).

Before using the ES400 for the first time, charge the battery using the provided USB Rapid Charge Cable (25-128458-01R) or the optional One Slot USB Charge cradle. For cable and cradle setup and charging procedures see [Chapter 12, Accessories](#).

Place the ES400 into the cradle or connect the cable. The battery automatically begins charging. See [Table 2-4](#) for charging indications. The 1540 mAh battery fully charges in less than three hours and the 3080 mAh battery fully charges in less than six hours.

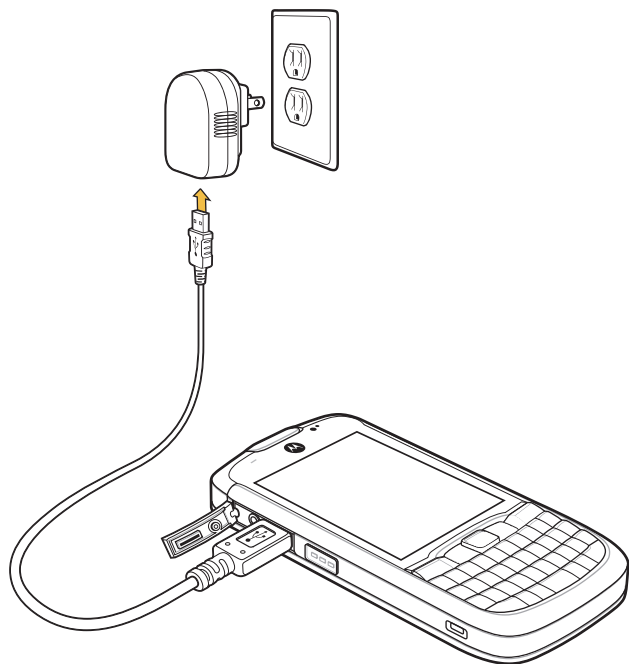

Figure 2-25 Charging ES400 with Power Supply

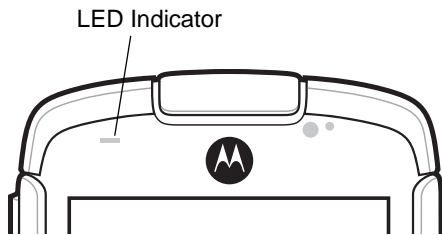

Figure 2-26 LED Indicator

Table 2-4 Charge Indication

LED Indication	Description
Off	Indicates that the: <ul style="list-style-type: none"> • not connected to power • battery is not charging.
Slow Blinking Green (1 blink every 2 seconds)	Indicates that the battery is charging.
Solid Green	Indicates that the battery is fully charged.
Fast Blinking Red (2 blinks/second)	Indicates a charging error, e.g.: <ul style="list-style-type: none"> • temperature is too low or too high. • charging has gone on too long without completion.

Charging Temperature

Charge batteries in temperatures from 0°C to 40°C (32°F to 104°F). Note that charging is intelligently controlled by the ES400.

To accomplish this, for small periods of time, the ES400 alternately enables and disables battery charging to keep the battery at acceptable temperatures. The ES400 indicates when charging is disabled due to abnormal temperatures via its LED. See [Table 2-4](#).

Battery Status Indications

Battery icons appear on the **Status Bar** indicating the battery power level. When the battery power falls below a predetermined level the icon indicates the status and a battery dialog box appears indicating the status of the battery.

The message displays until the user taps **Dismiss**. Alternately tap the **Status Bar** to display the **Device Management** window. Tap .

Printing

The ES400 supports printing to third-party printers. The Motorola Print Manager, available from the Support Central web site <http://supportcentral.motorola.com>, provides support for printing to Bluetooth enabled printers. The ES400 also supports printing using the USB Host Adapter and a USB cable. See [Chapter 12, Accessories](#) for more information.

Resetting the ES400

To perform a reboot, simultaneously press the **Power** button and the **1** and **9** keys.

Locking the ES400

The user can lock the ES400 to disable key presses and screen tap or by requiring a password or finger swipe to keep your data secure. Refer to [Locking the ES400 on page 11-3](#) for information on setting up device locking.

✓ **NOTE** The user can make emergency calls even when the ES400 is locked.

The lock screen displays whenever the ES400 is locked. When the ES400 is locked, you still receive notifications of new messages, missed calls and upcoming appointments. You can also receive a call when the ES400 is locked. The ES400 locks when a time out has occurred or you lock the ES400 manually.

To manually lock the ES400 tap the lock icon in the center of the Home screen Tile bar.

Password Unlocking

When the ES400 is not used for a period of time and the user tries to access the device, the Lock screen appears.

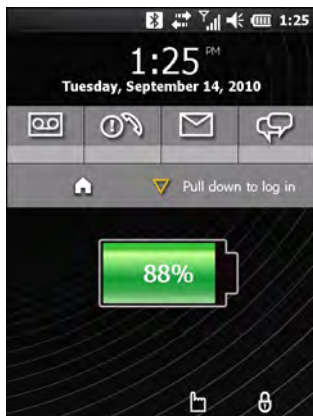

Indicates PIN Password Enabled

Indicates Fingerprint Enrolled

Figure 2-27 Lock Window

1. Select one of the item icon to open when the ES400 is unlocked.
2. Touch gray bar and pull down to login.



Figure 2-28 Enter Password Window

3. In the text field enter your pin and then tap the unlock icon.

Finger Swipe Un-locking

When the ES400 is not used for a period of time and the user tries to access the device, the Lock screen appears. Swipe your finger across the fingerprint reader in the direction used during enrollment. If the fingerprint sensor does not read the fingerprint properly, enter a PIN to un-lock the ES400. See [Locking the ES400 on page 11-3](#) for information on setting up fingerprint reading.

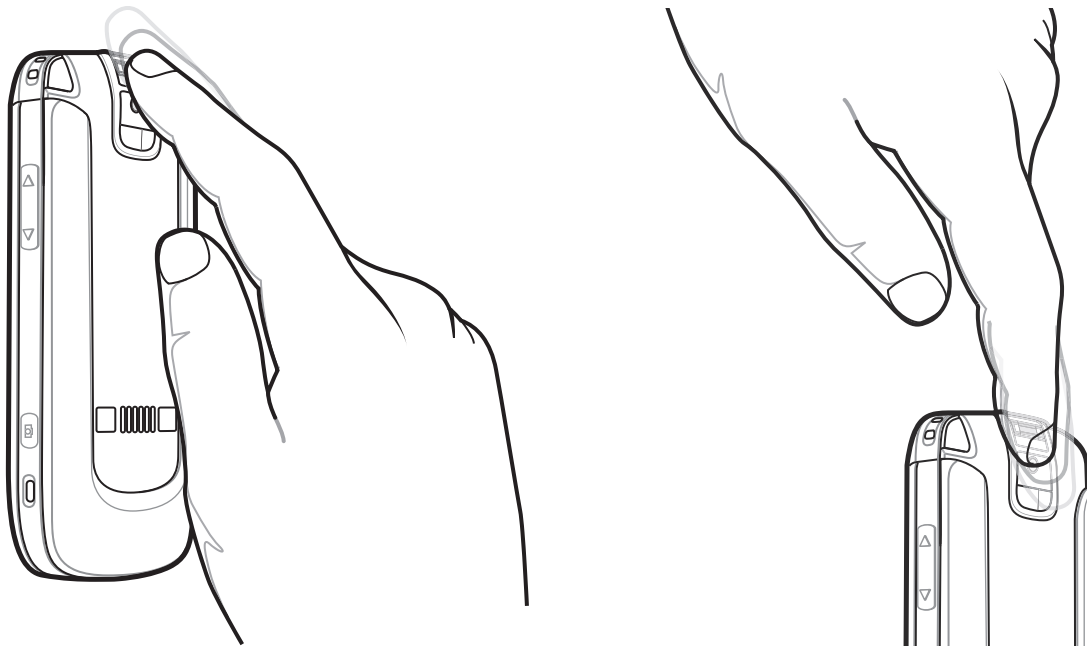

Figure 2-29 Swipe Finger Across Fingerprint Reader

Notifications When ES400 is Locked

The Lock screen displays the following notifications:

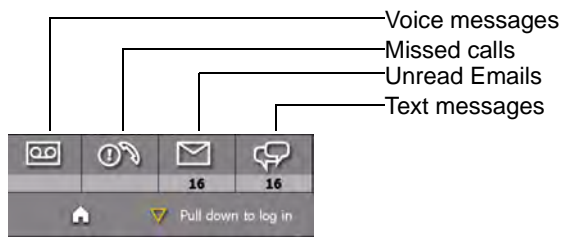

Figure 2-30 *Lock Screen Notifications*

Chapter 3 Making Calls

Introduction

- ✓ **NOTE** If using the Windows Mobile Dialer, refer to [Windows Mobile Dialer on page C-4](#) for information on using the dialer.

Use the ES400 to make phone calls, keep track of calls, and send text messages. Your wireless service provider may also provide other services such as voice mail, call forwarding, and caller ID.

Also use the phone to connect to an ISP or work network in order to browse the Web and read email over High-Speed Packet Access (HSPA) or Evolution Data-Optimized (EvDO) using Cellular Line.

Making a Call

- ✓ **NOTE** The user can make emergency calls even when the ES400 is locked or when it is not activated. See [Emergency Calling on page 3-5](#) for more information.

With the ES400, the user can make a call from the phone, contacts, and Call Log.

Using the Phone Keypad

To make a call:

1. Press .



Figure 3-1 Enterprise Dialer

✓ **NOTE** If the user taps a wrong number, tap the Delete key to erase each subsequent digit. To erase the entire number, tap and hold the Delete key.









2. Enter the phone number on the dialer or keypad. The number appears in the Call Line.
3. Tap the green Call Line or press .
4. Tap **Cancel** to cancel the call or tap **Speaker** to place the ES400 in speakerphone mode.
5. When the call connects, the name or number appears in the Call Line. To place the call on hold tap the Call Line. To return to the call tap the Call Line again.
6. Tap  or press  to end the call.

Table 3-1 lists the Phone dialer icons that appear below the Status bar and above the Call Line. Icons vary depending upon carrier and network.

Table 3-1 Phone Dialer Status Icons

Icon	Description	Icon	Description
	Bluetooth headset connected.		Location disabled.
	Call Forwarding enabled.		Phone unlocked.
	Phone audio muted.		

Smart Dialing

Smart Dialing makes it easy to dial a phone number. When the user starts entering numbers or characters, Smart Dialing automatically searches and sorts the contact entries on the SIM card, in Contacts, and the phone numbers in Call Log (including incoming, outgoing, and missed calls). You can then select the desired number or contact from the filtered list to dial.

Press the keys on the ES400 keypad that correspond to the phone number or contact to call. The contact panel lists contacts that match the sequence entered.

Smart Dialing starts looking for numbers or contacts that match the sequence entered.

To find a phone number:

- Enter the first one or two digits to find a phone number in Call History.
- Enter the first three digits or more to find a phone number from the saved Contacts and SIM card.

To find a contact name:

- Enter the first letter of a contact's first name or last name. Smart Dialing searches for the letter starting from the first character of a contact name as well as from any character that appears after a space, dash, or underscore in a contact name.
- If the matching list is long, narrow down the search further by entering another letter.

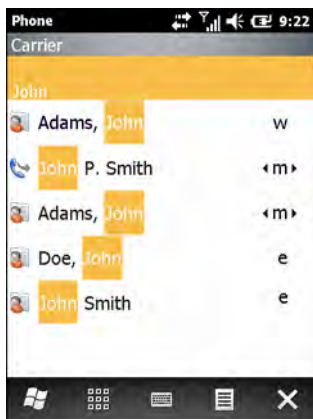





Figure 3-2 Finding a Contact

To make a call or send a message using Smart Dialing:

1. Begin entering the first few numbers or characters.
2. In the **Smart Dialing** panel, touch the screen or use the Optical Nav Pad on the keypad to navigate to the desired contact or phone number.
3. When the correct contact is selected, press  to make a voice call.
4. To send a message to the selected contact, tap  > **Send Text Message** to send a text message or  > **Send MMS** to send an MMS message.
5. To call a different phone number associated with the selected contact, tap the contact name and select the phone number to call.

Using Contacts

Use **Contacts** to make a call without looking up or entering the phone number.





To make a call from **Contacts**:

1. Press .

2. From the Phone shortcut, tap .
3. From the contact list, tap and hold the contact name.
4. Tap **Call Work**, **Call Home** or **Call Mobile**.

Using Call Log

To make a call using Call Log:

1. Press .
2. From the Phone shortcut, tap .
3. Tap the contact or phone number.
4. Tap **SEND** or press .
5. Tap **Cancel** or press  to stop dialing or end the call.

Answering a Call



When the ES400 receives an incoming call a dialog box appears. If the phone is set to ring, a ring tone sounds. Answer or ignore the incoming call.

To answer an incoming call tap **Answer** or press .

To ignore the incoming call, tap **Ignore**. This sends the caller to voice mail, depending on the service provider. Otherwise, this presents a busy signal to the calling party.

Tap  or press  to end the call.

Incoming Call Features

- The user can use other programs on the ES400 during a call. To switch back to the phone, press . Press  to end the call.
- To hold the current call and answer a waiting call, tap **Answer** to place the current call on hold and answer the incoming call.
- To put a call on hold to call another number, tap **Hold**.
- To move from one call to another, tap **Swap**.

Missed Call Notification

When the user does not answer an incoming call, the Home screen displays a **Missed Call** indication.

To view a missed call entry, tap the  on the **Home** screen.

Emergency Calling

The service provider programs one or more emergency phone numbers, such as 911 or 999, that the user can call under any circumstances, even when the phone is locked, a SIM card is not inserted or the phone is not activated. Your service provider can program additional emergency numbers into the SIM card. However, the SIM card must be inserted in the ES400 in order to use the numbers stored on it. See the service provider for additional information.

When the keypad is locked, press the orange **fn** key twice to set the keypad to numeric mode and then enter the emergency number.

Audio Modes

The ES400 offers three audio modes for use during phone calls:

- **Handset Mode:** Switches audio to the receiver at the top front of the ES400, so the user can use the ES400 as a handset. This is the default mode.
- **Speaker Mode:** Use the ES400 as if on speaker phone. Tap **Speaker** to activate this mode. Tap **Speaker** again to switch back to handset mode.
- **Headset Mode:** Connect a Bluetooth headset or a wired headset to automatically switch audio to the headset.

The ES400 defaults to handset mode. When a wired headset is plugged into the ES400 headset port or a Bluetooth headset is configured for use with the ES400, the earpiece and speakerphone are muted and audio is heard through the headset.

Using a Bluetooth Headset

You can use a Bluetooth headset for audio communication when using an audio-enabled application. See [Chapter 9, Bluetooth](#) for information on connecting a Bluetooth headset to the ES400. Set the ES400's volume appropriately before putting the headset on. When a Bluetooth headset is connected the speakerphone is muted.

Adjusting Audio Volume

Use the Volume buttons to adjust the volume of the ringer when not in a call and the audio volume when in a call.



NOTE Adjust the conversation phone volume during a call. Adjusting the volume while not in a call affects the ring and notification sound levels.

Muting a Call

During a call, the caller can mute the microphone so they can hear the person on the line but he or she cannot hear the caller. This is useful when there is conversation or background noise.

To mute or unmute a call tap **Mute** on the dialer to mute the audio. The **Mute** button becomes yellow.

Using Call Log





Use Call Log to call someone who was recently called, or recently called in. The **Call Log** provides the time of all incoming, outgoing, and missed calls. [Table 4-1](#) lists the call Log icons that appear in the **Call Log** window.

Press  and then tap  to open the **Call Log** window.



Figure 3-3 Call Log Window

Table 3-2 Call Log Icons



Icon	Description
	This icon appears next to the contact information for all outgoing calls.
	This icon appears next to the contact information for all incoming calls.
	This icon appears next to the contact information for all unconnected outgoing calls.
	This icon appears next to the contact information for all missed incoming calls.

Managing Call Log

Change views, reset the call timer, and delete calls to manage the calls stored in Call Log.

Using the Call Log Menu

Use the **Call Log** menu to make a call, send an SMS and remove item from the log.

1. Press  and then tap .
2. Tap an item to call the number or tap  to open the **Options** window for that item.

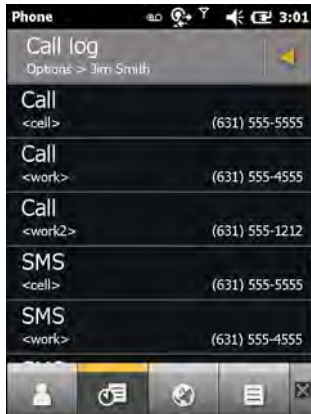



Figure 3-4 Call Log Options

3. Select an applicable option from the list.
4. Depending on the option selected, the appropriate window displays. For example, select **SMS** to display the **Text Messages** window.
5. Tap  to close the **Options** window.

Conference Calling

 **NOTE** For use on GSM/UMTS networks.

Conference Calling and the number of conference calls allowed may not be available on all services. Please check with the service provider for Conference Calling availability.

To create a conference phone session with multiple people:



1. Press  to display the dialer.
2. Enter the first phone number and tap the Call Line area. When the call connects, the name or number appears in the Call Line.
3. Tap .
4. Tap . The dialer re-appears.
5. Enter the second number and tap **Send**.
6. When the call connects, the first call is placed on hold and the second call is active.



Figure 3-5 *Two Calls*



7. Tap the Call Line 1 to make that call active. The second call go on hold.
8. Tap  to create a conference call (three callers).



Figure 3-6 *Two Merged Calls*

9. To add a third caller tap . The dialer appears. When the call connects the new call is active and the conference is on hold.

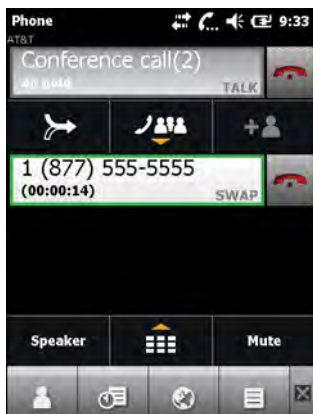



Figure 3-7 *Adding a Third Call*

10. To add the new caller to the conference tap .

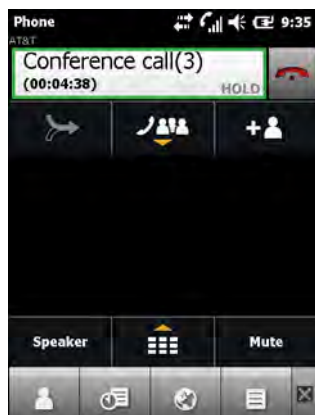

Figure 3-8 *Three Merged Calls*

11. Tap  to view all callers.

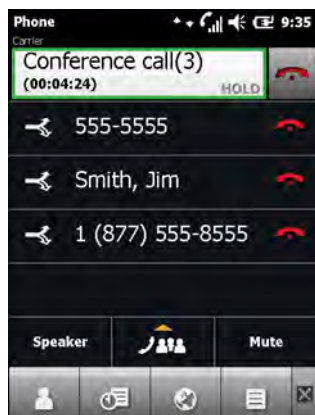





Figure 3-9 *Un-Merge Calls*

12. Tap  to remove a caller from the conference.

13. To end the conference call, tap  next to the Call Line.

Calls Complete dialog appears and then the dialer displays.

✓ **NOTE** To speak privately with one party during a conference call, tap  and then tap  next to the caller.

To include all parties again, tap .

Making a 3-Way Call

✓ **NOTE** For use on CDMA networks.

3-way Calling may not be available on all services. Please check with the service provider for availability.

With 3-Way Calling, you can talk to two people at the same time. When using this feature, the normal airtime rates will be charged for each of the two calls.

1. Enter a number and press .
2. Once you have established the connection, enter or select a number and tap **Flash**.
3. When you're connected to the second party, tap **Flash** to begin your 3-way call.

If one of the people you called hangs up during your call, you and the remaining caller stay connected. If you initiated the call and are the first to hang up, all callers are disconnected.

Voice Commander

Voice Commander is a speech dialog system that provides natural human interface for users to communicate seamlessly with the ES400. Users can make phone calls, look up contact information, launch programs or check calendars. Voice Commander contains the following features:

- Eyes-free and hands-free voice command and control.
- Speaker-independent speech recognition technology, no training is required.
- Ease of use conversational user interface.
- Personal Voice Tag and Digit Model Adaptation to enhance the usability.

To initiate Voice Commander tap **Start > Toolbox > Voice Commander** or press the call button on a Bluetooth headset. The system says, "Say a Command." The user says one of the following commands:

- Call
- Find
- Redial/Callback
- Play Music
- Play
- Next/Previous
- Start
- Appointments
- Read/Call History
- What time is it?
- What can I say?
- Goodbye

Call

To call a person by name:

1. Initiate **Voice Commander**. The ES400 responds with “*Say command.*”
2. Say “*Call Michael Archer.*” System responds with “*Call Michael Archer work, is it correct?*”
3. Say “*Yes.*” ES400 responds with “*Dialing.*”

To call a person at a location:

1. Initiate **Voice Commander**. The ES400 responds with “*Say command.*”
2. Say “*Call Mary Smith at home.*” The ES400 responds with “*Call Mary Smith home, is it correct?*”
3. Say “*Yes.*” The ES400 responds with “*Dialing.*”

To call a person with more than one phone number:

1. Initiate **Voice Commander**. The ES400 responds with “*Say command.*”
2. Say “*Call Alex Jordan.*” The ES400 responds with “*Call Alex Jordan, home, work, mobile or cancel?*”
3. Say “*Home.*” The ES400 responds with “*Dialing.*”

If two people have similar names:

1. Initiate **Voice Commander**. The ES400 responds with “*Say command.*”
2. Say “*Call Halley Johnson.*” The ES400 responds with “*More than one Halley Johnson, please select.*”
3. Select the contact intended to call.



NOTE **Voice Commander** automatically maintains a maximum of 2000 contacts in the recognition database. To change this setting, see [Contacts Settings on page 11-27](#).

If the command can not be recognized, **Voice Commander** prompts “Please say again.” This situation could happen under the noisy environment, or when user says command before **Voice Commander** starts recording. After hearing the prompt “Say Command”, user should wait one to two seconds to speak the command.

The recognizable contact length is 48 characters. Contacts exceeding 48 characters will be ignored.

Find

To look up contact information:

1. Initiate **Voice Commander**. The ES400 responds with “*Say command.*”
2. Say “*Find Mary Smith.*” System responds with “*Mary Smith home 5555551212.*”

To look up a specific number:

1. Initiate **Voice Commander**. The ES400 responds with “*Say command.*”
2. Say “*Find Michael Archer at work.*” The ES400 responds with “*Michael Archer, work, 5555551212.*”

If two contacts have similar names:

1. Initiate **Voice Commander**. The ES400 responds with “*Say command.*”

2. Say "Find John Smith at work." The ES400 responds with "*More than one John Smith, please select.*" Voice Commander displays a window with the two contacts. (System will show both Halley Johnson and Haley Johnson for user to select.)

If a contact is not found:

1. Initiate **Voice Commander**. The ES400 responds with "*Say command.*"
2. Say "Find Michael Archer at home."
3. ES400 responds with "*Michael Archer has no home number.*"

Redial

To re-dial a previous number:

1. Initiate **Voice Commander**. The ES400 responds with "*Say command.*"
2. Say "Redial." The ES400 responds with "*Call Mary Smith at home, is it correct?*"
3. Say "Yes." The ES400 responds with "*Dialing.*"

Callback

1. Initiate **Voice Commander**. The ES400 responds with "*Say command.*"
2. Say "Callback." The ES400 responds with "*Call Mary Smith at home, is it correct?*"
3. Say "Yes." The ES400 responds with "*Dialing.*"

Start

To launch an application:

1. Initiate **Voice Commander**. The ES400 responds with "*Say command.*"
2. Say "Start calendar." The ES400 responds with "*Go to Calendar.*" The **Calendar** application launches.

Appointments

To read today's, tomorrow's or this week's appointments:

1. Initiate **Voice Commander**. The ES400 responds with "*Say command.*"
2. Say "Today's appointment." The ES400 responds with "*You have 3 appointments.*"
3. If you remapped the programmable button to Voice Commander, press the programmable button during calendar reading. The ES400 responds with "*Please say Previous, Next, Repeat, or Abort.*"
4. Say "Next." The ES400 reads the next appointment.

Read

To read a text message or an email message:

1. Initiate **Voice Commander**. The ES400 responds with "*Say command.*"
2. Say "Read SMS." The ES400 responds with "*You have 3 SMS.*"

3. If you remapped the programmable button to Voice Commander, press the programmable button during SMS reading. The ES400 responds with *"Please say Previous, Next, Repeat or Abort."*
4. Say "Next." The ES400 reads the next SMS message.

✓ **NOTE** User can say Previous, Next, Repeat, or Abort to control SMS reading.

What time is it

To find out the time of day:

1. Initiate **Voice Commander**. The ES400 responds with *"Say command."*
2. Say "What time is it?" The ES400 responds with *"The time is 3 p.m."*

Call History

To view the call history window:

1. Initiate **Voice Commander**. The ES400 responds with *"Say command."*
2. Say "Call History." The ES400 responds with *"Call history."*
3. The Call history page displays.

Voice Play Music

To play a specific music file:

1. Initiate **Voice Commander**. The ES400 responds with *"Say command."*
2. Say "Play The Moment." The ES400 responds with *"The Moment."*
3. Windows Media starts to play *"The Moment."*

To play all music files:

1. Initiate **Voice Commander**. The ES400 responds with *"Say command."*
2. Say "Play music." The ES400 responds with *"Play music."*
3. Windows Media starts to play all music files.

To play a different music file during playing of another:

1. Initiate **Voice Commander**. The ES400 responds with *"Say command."*
2. Say "Next." The ES400 responds with *"Next."*
3. Windows Media starts to play next music file.

To pause or resume a playing music file:

1. Initiate **Voice Commander**. The ES400 responds with *"Say command."*

2. Say "Pause" or "Resume." The ES4000 pauses or resumes the playing music.

✓ **NOTE** User can say "Pause" or "Resume" to control music playing. The command "Resume" only works when Windows Media is running. The commands "Previous" and "Next" only work when playing all music files.

Voice Commander only supports media files with .mp3 and .wma format. **Voice Commander** supports the music files in Playlists or Media files synced by Active Sync, in **My Documents** and its subfolder or on the microSD card and its subfolders.

What can I say

To view the help information:

1. Initiate **Voice Commander**. The ES400 responds with "Say command."
2. Say "What can I say." The help file displays.

Alternately tap **Menu > Help** to open the help file.

Goodbye

To exit the **Voice Commander** application, Say "Goodbye." The ES400 responds with "Goodbye" and the application terminates.

Voice Commander can be also terminated manually by tapping **Menu > Exit**. Note that goodbye will not be accepted during voice digit dialing operation.

✓ **NOTE** **Voice Commander** automatically terminates after 10 seconds of silence.

Chapter 4 Phone Network Setup

Introduction

If the cellular service is with AT&T, Telcel, Bell Mobility, Telstra, or any other operator that supplies a SIM card, install the SIM card into the ES400. Refer to [Installing the SIM Card \(GSM Only\) on page 1-4](#) for more information. Note that first-time power-up may take up to five minutes, as the ES400 automatically configures itself for the carrier.

If the cellular service is with a carrier that requires calling-in for activation, such as Verizon or Sprint, activate using the **Phone Network Setup** application. It may take 10 to 15 minutes to complete the activation the first time. Note that another phone needs to be available, for calling your wireless operator's customer service department. Also, the ES400 needs to be in-coverage, i.e. in the service area, of your wireless operator, for it's activation process to complete.

If the user has a Global Phone service with Verizon or Sprint, and has a SIM card as part of the service, power-up the ES400 and complete activation, without inserting the SIM card. Insert the SIM card afterwards.

The **Phone Network Setup** application provides the ability to change networks when detected: by the ES400 or manually: when the user decides to change networks

Automatic Network Setup

See [Network Activation on page 1-7](#) for information on activating the ES400 upon startup.

Manual Network Setup

- ✓ **NOTE** When an AT&T SIM card is installed in the ES400, the user interface for the CDMA settings is hidden. To restore access to these settings, please contact Motorola Enterprise Mobility Support.

CDMA Network Setup

- ✓ **NOTE** Upon a Master Reset or a software upgrade, CDMA users must restore data services and MMS settings. Tap **Start > Setting > Connections > Phone Network Setup**. On the **Band** tab, tap **Network Type** and select either **CDMA Only** or **CDMA First**.

To manually configure the ES400 for a CDMA network:

1. Tap **Start > Setting > Connections > Phone Network Setup**.

2. On the **Band** tab, select the Network Type:
 - **CDMA Only** - Searches for only CDMA networks. GSM/UMTS networks are ignored.
 - **CDMA First** - Searches first for CDMA networks and then for GSM/UMTS networks if CDMA networks are not found.
3. On the **CDMA Setup** tab, tap **Preferred network** and select your carrier.
4. Tap **Start Activation** button.
5. On the **Phone Network - CDMA Activation** dialog box, tap **Yes**.
6. On an active phone line, call your carrier to activate the ES400. Provide the MEID number on the screen to the customer representative.
7. When requested, tap **Activate Now** to activate the ES400.

GSM Network Setup

To manually configure the ES400 for a GSM/UMTS network:

1. Install an active SIM card into the ES400. Refer to [Setting Up the ES400 on page 1-2](#).
2. Tap **Start > Setting > Connections > Phone Network Setup**.
3. On the **Band** tab, select the Network Type:
 - **GSM/UMTS Only** - Searches for only GSM/UMTS networks. CDMA networks are ignored.
 - **GSM/UMTS First** - Searches first for GSM/UMTS networks and then for CDMA networks if GSM/UMTS networks are not found.
4. Select **GSM/UMTS Preferred** and select:
 - **Auto (GSM & UMTS)** - Searches for either GSM or UMTS networks.
 - **GSM Only** - Searches for only GSM networks.
 - **UMTS Only** - Searches for only UMTS networks.
5. Tap **Band**. Select:
 - **All** - Configures the ES400 to use all bands.
 - **NA & CA** - Configures the ES400 to use bands used in North America and Canada.
 - **EMEA/APAC/Brazil** - Configures the ES400 to use bands used in the Europe, Middle East, Africa (EMEA) region, Asia Pacific (APAC) region and Brazil region.
6. On the **GSM/UMTS** tab, tap **Preferred network** and select your carrier.
7. Tap the **Update Connection Settings** button.



NOTE SIM cards of supported carriers automatically configure the data connection and MMS settings upon activation. Data connection and MMS settings for non-supported carriers must be manually configured. See [Configuring a GSM Data Connection on page 4-4](#) and [MMS Messaging on page 11-26](#) for set up information.

The Public Land Mobile Network (PLMN) tab displays only when **Network Type** is set to **GSM/UMTS Only**.

Tap **Show List** to display the PLMN list.

Dual Network Usage

The ES400 can be set up to be used on both a CDMA and GSM/UMTS networks and the user can switch between them.

✓ **NOTE** Each active network account uses its own phone number.

When an AT&T SIM card is installed in the ES400, the user interface for the CDMA settings is hidden. To restore access to these settings, please contact Motorola Enterprise Mobility Support.

1. Obtain an active GSM/UMTS SIM card.
2. Activate the ES400 on a CDMA network. See [CDMA Network Setup on page 4-1](#).
3. Install the SIM card. See [Installing the SIM Card \(GSM Only\) on page 1-4](#).

To set the ES400 to use the CDMA network:

1. Tap > **Start** > **Setting** > **Connections** > **Phone network Setup**.
2. On the **Band** tab, tap **Network type** and select **CDMA First** or **CDMA Only**.
3. Tap **OK**.

To set the ES400 to use the GSM/UMTS network:

1. Tap > **Start** > **Setting** > **Connections** > **Phone network Setup**.
2. On the **Band** tab, tap **Network type** and select **GSM/UMTS First**.
3. On the **GSM/UMTS** tab, tap the **Update Connection Settings** button.
4. Tap **OK**.

Global Usage

ES400 devices provisioned to a CDMA network can be used internationally with the use of a Global SIM card provided by the CDMA carrier. After arriving, install the global SIM card into the ES400. See [Installing the SIM Card \(GSM Only\) on page 1-4](#).

To set the ES400 to use the global SIM card:

1. Tap > **Start** > **Setting** > **Connections** > **Phone network Setup**.
2. On the **Band** tab, tap **Network type** and select **GSM/UMTS First**.
3. Tap **GSM/UMTS Preferred** and select **Auto (GSM & UMTS)**, **GSM Only** or **UMTS Only**.
4. Tap **Band** and select **All, NA & CA**, **EMEA/APAC** or **Brazil**.
5. On the **GSM/UMTS** tab, tap the **Update Connection Settings** button.

✓ **NOTE** If using an unsupported network, data connection and MMS settings must be manually configured. See [Configuring a GSM Data Connection on page 4-4](#) and [MMS Messaging on page 11-26](#) for set up information.

6. Tap **OK**.

7. Upon return, remove the global SIM card.
8. Tap > **Start** > **Setting** > **Connections** > **Phone network Setup**.
9. On the **Band** tab, tap **Network type** and select **CDMA First** or **CDMA Only**.
10. Tap **OK**.

Configuring a GSM Data Connection

- ✓ **NOTE** SIM cards of supported carriers automatically configure the data connection upon activation. Data connections for non-supported carriers must be manually configured.

A data connection allows Internet access across a wireless network.

To set up a new data connection:

1. Acquire an Access Point Name (APN) from the service provider.
2. Tap **Start** > **Settings** > **Connections** > **Connections** > **Tasks**.
3. Under **My ISP** select **Add a new modem connection**.
4. Enter a connection name in the **Enter a name for the connection** text box.
5. Select **Cellular Line (GPRS)** from the **Select a modem:** drop-down list.
6. Tap **Next**.
7. Enter the APN from the service provider in the **Access point name** text box.
8. Tap **Next**.
9. Enter a username in the User name text box, if required by the service provider.
10. Enter a password in the Password text box, if required by the service provider.
11. Enter a domain name in the Domain text box, if required by the service provider.
12. Tap **Finish**.
13. Tap **OK** to exit **Connections**.

Phone Settings

Use the **Phone Settings** window to customize settings, such as the ring type and ring tone for incoming calls, security options, and other options depending on the type of service.

Sounds

Use the **Sounds** tab to customize ring type, ring tone, keypad tone.

Tap **Start** > **Settings** > **Personal** > **Phone** > **Sounds**.

1. Select a ring type from the **Ring type:** drop-down list. The ring type changes the way the ES400 rings when it receives an incoming call. Regardless of the ring type selected, a dialog box appears on the ES400's display for incoming calls.

2. Select a ring tone for incoming calls from the **Ring tone:** drop-down list. To hear a sample of the selected ring tone, tap . Tap  to end the ring tone.

✓ **NOTE** To use custom .wav, .mid, or .wma files as ring tones, use ActiveSync on the host computer to copy the file to the /Windows/Rings folder on the ES400. Then select the sound from the ring tone list.

3. Select a keypad tone from the **Keypad:** drop-down list. This selection determines the tone that sounds when entering a phone number on the keypad.

Select **Short tones** or **Long tones** to specify the duration of the sound when you press a number on the keypad. Select **Off** to disable tones.

✓ **NOTE** Turning off sounds saves power and prolongs battery life.

Security

Enabling a PIN

Tap **Start > Settings > Personal > Phone > Security**.

✓ **NOTE** Place emergency calls at any time, without requiring a PIN or a SIM card.

To require a PIN when using the phone:

1. Select the **Require PIN when phone is used** check box.
2. Use the dialer keypad to enter a four to eight digit PIN.
3. Tap **Enter** to enable the PIN and return to the **Security** tab.

Changing a PIN



CAUTION If the user enters an incorrect PIN, the message “SIM PIN incorrect: Try again” appears. After three consecutive incorrect attempts, the SIM card is blocked. The phone does not allow entering a PIN again and the user must obtain a PIN Unblock Key from the service provider.

1. Tap **Change PIN**.
2. Use the dialer keypad to enter the current PIN.
3. Tap **Enter**.
4. Use the dialer keypad to enter a new four to eight digit PIN.
5. Tap **Enter**.
6. Reenter the new PIN for confirmation and tap **Enter**.
7. Tap **OK** to confirm the change.

Disabling a PIN

1. Deselect the **Require PIN when phone is used** check box.
2. Use the dialer keypad to enter the current PIN.

3. Tap **Enter**.
4. Tap **OK** to confirm the change and exit settings.

GSM Services

Use the **GSM Services** tab to configure settings for subscribed phone services. For example, block certain types of incoming and/or outgoing calls ([page 4-6](#)), disclose the caller's identity when making outgoing calls ([page 4-6](#)), forward incoming calls to a different phone number ([page 4-6](#)), receive notification of incoming calls when a phone session is in use ([page 4-6](#)), and set up voice mail and short message service ([page 4-7](#)).

1. Tap **Start > Settings > Personal > Phone > GSM Services**.
2. Select a service from the list and tap **Get Settings**.
3. Change services settings as follows.

Call Barring (Call Blocking)

Use call barring to block certain types of incoming and/or outgoing calls. Select the type of incoming and/or outgoing calls to block.

Caller ID

Enable caller ID to reveal the identity of the person making an outgoing call. Select the **Everyone** radio button to always display the caller ID. Select the **No one** radio button to prevent the caller's identity from appearing to others.

Call Forwarding

✓ **NOTE** Call Forwarding may not be available on all networks. Check with the service provider for availability.

Use call forwarding to forward incoming calls to a different phone number.

- To forward all calls to a different phone number:
 - select the **Forward all incoming phone calls** check box.
 - enter the phone number to receive forwarded calls in the **To:** text box.
- To forward incoming calls to a different phone number based on a specific situation, select one or more of the check boxes under **Forward phone calls only if:**
 - **No answer:** enter the phone number to receive forwarded calls only when the phone cannot be answered. Then select a time period from the **Forward after:** drop-down list. Options are 5, 10, 15, 20, 25, and 30 seconds.
 - **Unavailable:** enter the phone number to receive forwarded calls only when the phone is turned off or the user is unreachable.
 - **Busy:** enter the phone number to receive forwarded calls only when the line is busy.

Call Waiting

✓ **NOTE** Call Waiting may not be available on all networks. Check with your service provider for availability.

Call waiting notifies the user of an incoming call when the phone is in a phone session. Select the **Notify me** radio button to enable call waiting. Select the **Do not notify me** radio button to disable call waiting.

Voice Mail and Text Messages

To use voice mail and send short messages, enter the voice mail and/or text message phone number in the appropriate text boxes.

Fixed Dialing

Use Fixed Dialing to restrict the phone to dial only the phone number(s) or area code(s) specified in a Fixed Dialing list.

1. Select **Fixed Dialing** and tap **Get Settings**.
2. Select the **Enable fixed dialing** check box.
3. To add a number to the list, tap **Menu > Add**.
4. Enter the phone number or area code to restrict and tap **Done**.
5. Repeat steps 3 and 4 to add more numbers, and tap **Done** twice when complete.
6. Enter **PIN2** and tap **Done**.

✓ **NOTE** PIN2 is buffered in the ES400 indefinitely after entry and will not be requested again until a reboot of the ES400 has been performed. Should PIN2 be required, then the user must perform a reboot of the ES400.

Internet

Use the **Internet** tab to configure Internet calling.

Select an option from the down-down list.

Tap **OK**.

Broadcast Channels

Enable broadcast messages from local cell sites. These messages include emergency directions and information services.

TTY

Use an optional TTY device with the ES400 to send and receive calls. Plug the TTY device into the ES400's headset jack and set the ES400 to operate in 1 of 3 TTY modes.

✓ **NOTE** Use a TSB-121 compliant cable (provided by the TTY manufacturer) to connect the TTY device to the ES400.

Set the ES400 volume to a middle level setting for proper operation. If you experience a high number of incorrect characters, adjust the volume as needed to minimize the error rate.

For optimal performance, the ES400 should be at least 12 inches (30 centimeters) from the TTY device. Placing the ES400 too close to the TTY device may cause high error rates.

When you set the ES400 to a TTY mode, it operates in that mode whenever the TTY device is connected.

- **Headset** - Transmit and receive TTY characters using a headset.

- **VCO** - Receive TTY characters but transmit by speaking into microphone.
- **HCO** - Transmit TTY characters but receive by listening to earpiece.
- **Off** - Disable TTY functionality.

HAC

Turn Hearing Aide Compatibility (HAC) on and off.

Chapter 5 Using WLAN

Introduction

WLANs allow the ES400 to communicate wirelessly inside a building. Before using the ES400 on a WLAN, the facility must be set up with the required hardware to run the WLAN (sometimes known as infrastructure). The infrastructure and the ES400 must both be properly configured to enable this communication.

Refer to the documentation provided with the infrastructure (access points (APs), access ports, switches, Radius servers, etc.) for instructions on how to set up the infrastructure.

Once you have set up the infrastructure to enforce your chosen WLAN security scheme, use the Fusion or Wireless Zero Config (WZC) software to configure the ES400 to match.

Fusion Overview

The Fusion software contains applications with which to create wireless profiles. Each profile specifies the security parameters to use for connecting to a particular WLAN as identified by its ESSID. The Fusion software also allows the user to control which profile out of a set of profiles is used to connect. Other Fusion applications allow the user to monitor the status of the current WLAN connection and to invoke diagnostic tools for troubleshooting.

To access Fusion, tap the **Status Bar** > .

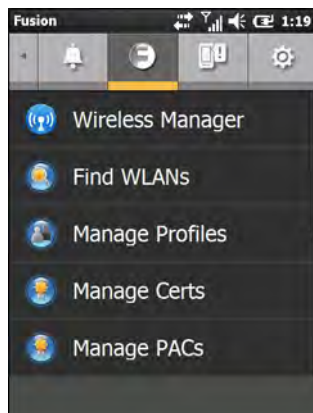



Figure 5-1 Status - Fusion Tab

Refer to the *Wireless Fusion Enterprise Mobility Suite User Guide for Version 3.20* for detailed information on using and configuring Fusion.

To access the on-device Fusion Help tap **Status Bar** >  > **Help**.

Wireless Zero Config Overview

WZC is a Microsoft wireless connection management utility that dynamically selects a wireless network to connect to based on a user's preferences and various default settings.

Switching Between Fusion and WZC

To switch from Fusion to WZC:

1. Tap the **Status Bar** >  > **Options**.
2. Select **WLAN Management** from the drop-down list.
3. Select **Windows Manages WLAN** radio button.
4. Tap **Save**.
5. Tap **OK**.
6. Perform a reboot.

To switch from WZC to Fusion:

1. Tap the **Status Bar** >  > **Options**.
2. Select **WLAN Management** from the drop-down list.
3. Select **Fusion Manages WLAN** radio button.
4. Tap **Save and then tap OK**.
5. Perform a reboot.

Supported Applications

The Fusion menu items and their corresponding applications are summarized in [Table 5-1](#).

Table 5-1 *Supported Applications*

Application	Description	Fusion Support	WZC Support
Wireless Manager	Opens the Wireless Manager application.	Yes	Yes
Find WLANs	Invokes the Find WLANs application which displays a list of the WLANs active in your area.	Yes	No

Table 5-1 Supported Applications (Continued)

Application	Description	Fusion Support	WZC Support
Manage Profiles	Invokes the Manage Profiles application (which includes the Profile Editor Wizard) to manage and edit your list of WLAN profiles.	Yes	No
Wireless Zero Config	Invokes the Wireless Zero Config application to configure the WLAN.	No	Yes
Manage Certs	Invokes the Certificate Manager application which allows you to manage certificates used for authentication.	Yes	Yes
Manage PACs	Invokes the PAC Manager application which helps you manage the list of Protected Access Credentials used with EAP-FAST authentication.	Yes	No
Options	Invokes the Options application which allows you to configure the Fusion option settings.	Yes	Yes
Wireless Status	Invokes the Wireless Status application which allows you to view the status of the current wireless connection.	Yes	Yes
Wireless Diagnostics	Invokes the Wireless Diagnostics application which provides tools with which to diagnose problems with the wireless connection.	Yes	Yes
Log On/Off	Invokes the Network Login dialog which allows you to log on to a particular profile or to log off from the currently active profile.	Yes	No

Fusion Setup

For detailed setup WLAN using Fusion refer to the *Wireless Fusion Enterprise Mobility Suite User Guide for Version 3.20* for detailed information on using and configuring Fusion.

To setup WLAN using Fusion:

- ✓ **NOTE** Obtain the proper WLAN configuration information from your system administrator prior to performing the Fusion setup procedures.

The following setup procedure example shows setup of a WLAN using WEP encryption.

1. Tap the **Status Bar** >  > **Manage Profiles**. The **Manage Profiles** window appears.
2. Tap and hold in the window and select **Add** from the pop-up menu. The **Wireless LAN Profile Entry** window appears.
3. In the **Profile Name** text box enter a name for the profile.
4. In the **ESSID** text box enter the ESSID.

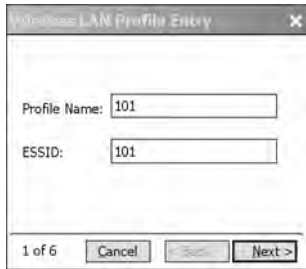

Figure 5-2 Profile ID Dialog Box

5. Tap **Next**. The **Operating Mode** dialog box displays.
6. In the **Operating Mode** drop-down list, select **Infrastructure** or **Ad-hoc**.

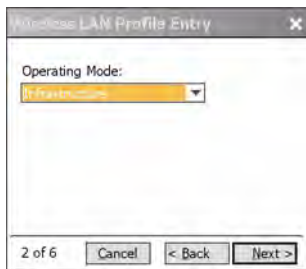

Figure 5-3 Operating Mode Dialog Box

7. Tap **Next**. The **Security Mode** dialog box displays.
8. In the **Security Mode** drop-down list, select **Legacy (Pre-WPA)**.



Figure 5-4 Security/Authentication Dialog Box

9. In the **Authentication** drop-down list, select **None**.
10. Tap **Next**. The **Encryption** dialog box displays.
11. In the **Encryption Type** drop-down list, select **WEP-40 (40/24)**.



Figure 5-5 Encryption Dialog Box

12. Select the **Pass-phrase** or **Hexadecimal Keys** radio button to indicate whether a pass-phrase or hexadecimal keys will be entered on the next page.
13. Select the **For added security - Mask characters entered** check box to hide characters entered. Deselect this to show characters entered.
14. Tap **Next**.



Figure 5-6 WEP-40 WEP Keys Dialog Box

15. In the **Edit Key** drop-down list, select the key to enter.
16. In the **Key** field, enter 10 hexadecimal characters.
17. In the **Confirm** field, re-enter the key. When the keys match, a message appears indicating that the keys match.
18. Repeat for each WEP key.
19. In the **Transmit Key** drop-down list, select the key to transmit.
20. Tap **Next**. The **IPv4 Address Entry** dialog box displays.

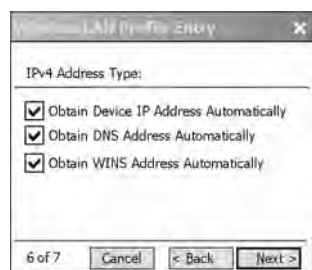

Figure 5-7 IP Address Entry Dialog Box

21. Ensure that all three check boxes are selected.
22. Tap **Next**. The **Battery Usage** dialog box appears.
23. In the **Battery Usage Mode** dialog box select a power consumption option.

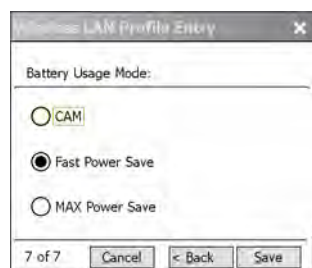

Figure 5-8 Battery Usage Dialog Box

24. Tap **Save**.

Wireless Zero Config Setup

To setup WLAN using WZC:

- ✓ **NOTE** Obtain the proper WLAN configuration information from your system administrator prior to performing the WZC setup procedures.

The following setup procedure example shows setup of a WLAN using WEP encryption.

1. Tap **Status Bar** >  > **Wireless Zero Config**.

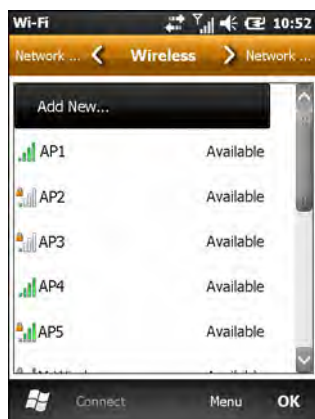

Figure 5-9 *Wireless Zero Config Window*

2. The ES400 searches for wireless networks in the area and displays them in the window.
3. Tap a network name.



Figure 5-10 *Configure Wireless Network Window*

4. In the **Connects to** drop-down list, select either **The Internet** or **Work**.
5. Check the **This is a hidden network** checkbox if the network is a hidden network.
6. Tap **Next**.



Figure 5-11 *Configure Network Authentication Window*

7. In the **Authentication** drop-down list, select the authentication type.
8. In the **Data Encryption** drop-down list, select the data encryption type.
9. If **WEP encryption** is selected, enter an encryption key in the **Network key** text box.
10. Tap **Next**.



Figure 5-12 *Configure Network Authentication Window*

11. If required, select **Use IEEE 802.1x network access control** check box.
12. In the **EAP type** drop-down list box, select the EAP type.
13. Tap **Finish**.

More Information on WZC

For more information on Microsoft Wireless Zero Config, see the Microsoft Software Developer Network (MSDN) at <http://msdn.microsoft.com>.

Chapter 6 Messaging

Introduction



This chapter describes how to use and setup Email, SMS Messaging and MMS Messaging.

Email

Use Messaging to send and receive Email.

Creating an Email Message

To create an email message:

1. Press .
2. Select an email account.
3. Tap  > **New**.
4. To add recipients, enter their email addresses, separating them with a semicolon (;). Tap **To** to add email addresses stored in **Contacts**.
5. Enter a subject and compose the message.
6. To add an attachment to the message, tap  > **Insert** and tap the item you want to attach: **Picture**, **Voice Note**, or **File**.
7. Tap .





Viewing an Email Message

To view an email message:

1. On the Home screen, tap  for an Outlook email or  for a personal email account.

2. Tap an email to open it.

Replying to or Forwarding a Message





1. On the Home screen, tap  for an Outlook email or  for a personal email account.
2. Tap an email to open it.
3. Tap .
4. Enter your reply message, and then tap .

SMS Messaging

Text messages allow the user to send and receive short text messages (SMS) to and from other mobile devices. The text can contain words, numbers, or an alphanumeric combination no longer than 160 characters.

Sending a Text Message

To send a text message:

1. Press  > **Text Messages**.
2. Tap  > **New** > **SMS**.
3. Tap **To** to select a recipient from **Contacts**.
4. Compose a message.
 - The auto-correct feature automatically fixes common spelling errors as the user types so that messages are more accurate.
 - The character counter, in the Status Bar, indicates the size of the message being composed.
 - Tap  > **Message Options**, then select the **Request message delivery notification** check box to request notification when the text messages is received.
5. Tap  to send the message.

If the ES400 phone feature is on, the text message is sent. If it's off, a prompt displays to turn on the phone feature. The message is saved in the **Drafts** folder and sent when the ES400 phone feature is turned on.

When outside of coverage area, the message is saved in the **Drafts** folder and sent when back in a coverage area.

Viewing Text Messages

When an incoming text message arrives, the text notification icon appears in the Status Bar and the dialog box displays.

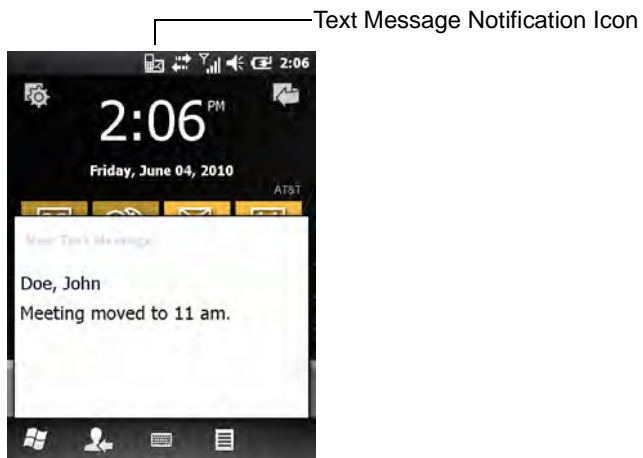





Figure 6-1 *New Text Message Notification*



The Caller Identification feature matches incoming text message numbers with those stored in **Contacts** indicating who is sending the message. Tap  to reply to the message. Tap  to call the sender, or save, dismiss or delete the message.

To view a text message:

1. Press  > **Text Messages**.
2. In the message list, tap a text message. The window displays previous text conversations.

Replying to an SMS Message

To reply to a text message:

1. Tap .
2. In the message list, tap a text message. The window displays previous text conversations.
3. Enter text in the reply field.
4. Tap .

MMS Messaging

MMS Messaging allows the user to send a pictures, videos, audio files and other file types to another phone.

Creating and Sending MMS Messages

To send an MMS message:

1. Press  > **Text Messages**.
2. Tap  > **New** > **MMS**.

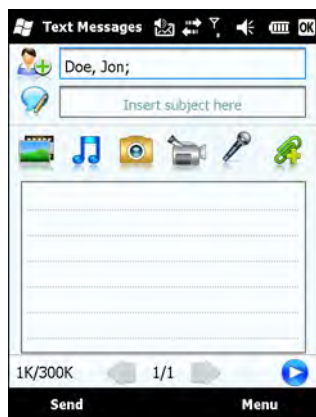











Figure 6-2 MMS Window

3. To add a contact, tap . A window appears with a list of contacts. Select one or more contacts and then tap **Done**.
4. Tap  to add a subject for the message. Enter the subject text in the window and then tap **Done**.
5. Tap in the text window to enter a text message. A window appears allowing you to add a text message plus emoticons, favorite web addresses, pre-defined text, contact information and calendar information. Tap Done after adding information.
6. Tap  to attach a picture or video stored on the ES400 to the message.
7. Tap  to attach a sound file stored on the ES400 to the message.
8. Tap  to take a picture and attach it to the message.
9. Tap  to capture video and attach it to the message.
10. Tap  to record a message and attach it to the message.
11. Tap  to add a file stored on the ES400 to the message.
12. After all of the items are attached to the message, tap **Send**.

Viewing an MMS Message

To view an MMS message:

1. Press  > **Text Messages**.
2. Tap the MMS message.
3. In the threaded message, tap the MMS icon to view the message.
4. Tap **Contents** to view a list of files included in the message.

On the **Message Contents** screen:

1. Tap **Menu** > **Save** to save a file.
2. Tap **Menu** > **Save into My Text** to save the contents of a text file to the My Text list.
3. Tap **Menu** > **Assign to Contact** to associate a photo to a contact.
4. Tap **Menu** > **Set as Ringtone** to associate a audio file as a ringtone.

Replying to an MMS Message

To reply to an MMS message

1. Press  > **Text Messages**.
2. Tap the MMS message.
3. In the threaded message, tap the MMS message to open and view an MMS message.
4. After viewing the MMS message, tap **Menu** > **Reply** > **via MMS** to reply with an MMS message or tap **Menu** > **Reply** > **via SMS** to reply with a text message.

Blocking Incoming MMS Messages

To block incoming MMS messages from a specific sender:

1. Open and view the MMS message.
2. Tap **Menu** > **Show** > **Contact Details**.
3. Tap **Menu** > **Save to Blacklist**.
4. Tap **Done**.

To unblock a sender:

1. Tap **My Apps** > **Text**.
2. Tap **Menu** > **MMS Options** > **Blacklist**.
3. Tap and hold the phone number.
4. Select **Delete** from the pop up menu.
5. Tap **OK**.

Chapter 7 Data Capture

Introduction

The ES400 offers data capture using the color digital camera.

Digital Camera Scanning

The camera uses digital camera technology to take a digital picture of a bar code, stores the resulting image in its memory, and executes state-of-the-art software decoding algorithms to extract the data from the image.

To read a bar code, a scan-enabled application is required. The ES400 contains the **DataWedge** application that allows the user to enable the camera, decode the bar code data and display the bar code content.

1. Enable **DataWedge**. See [Data Wedge on page 7-2](#).
2. Launch an application that supports text inputs, such as **Word Mobile 2010** or **Excel Mobile 2010**.
3. Point the camera lens on the back of the ES400 at a bar code.
4. Press and hold . A preview window appears on the display window and a red aiming line emits from the ES400. The LED lights red indicating that the data capture is in process.
5. Move the ES400 until the red aiming line is across the bar code.

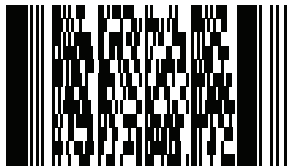

Figure 7-1 Sample Bar Code

6. The LED lights green and a beep sounds, by default, to indicate the bar code was decoded successfully.
7. The bar code content data displays in the text field.

Data Wedge

DataWedge allows the user to input captured bar code data into a text field of an application.

- ✓ **NOTE** When **DataWedge** is enabled, the Camera button on the right side of the ES400 enables data capture. After using the data capture feature, disable **DataWedge** to return the Camera button to its default function.

To enable **DataWedge**:

1. Tap **Start > Settings > System > DataWedge**.
2. Tap the **Running** option to start the DataWedge process. The DataWedge Status changes to **Ready**.
3. Tap **OK**.

To disable **DataWedge**:

1. Tap **Start > Settings > System > DataWedge**.
2. Tap the **Running** option to end the DataWedge process. The DataWedge Status changes to **Stopped**.
3. Tap **OK**.

Chapter 8 Using the Camera

Introduction

Use the Camera application to take pictures and record videos. The pictures and videos are automatically saved in the **Gallery** application, where the user can view and edit them. By default, captured pictures or videos are saved as JPEG or 3GP file.

Taking Pictures

Press the Camera button located on the lower-right side of the ES400.

The Camera screen displays the view finder. Depending upon what mode was last used, either Camera mode or Video mode is enabled. The icon in the top right corner indicates the mode. If video mode is enabled, tap anywhere on the screen to display the Status bar and then tap Camera icon.



Figure 8-1 *Camera View Finder*

To take a picture:

1. Point the ES400 at the subject.
2. Press the Camera button on the side of the ES400 or the Optical Nav Pad. The ES400 takes the picture and stores it in memory.

To take a panorama picture:

✓ **NOTE** Panorama picture quality is better outdoors.

1. Tap **Menu > Panorama** and select either **Horizontal** or **Vertical** and then tap **Close**.
2. Point the ES400 at the subject.
3. Press the Camera button on the side of the ES400 or the Optical Nav Pad. The ES400 takes the picture and displays two alignment targets on the screen.



Figure 8-2 *Panorama Alignment Targets*

4. Slowly move the ES400 to the right until the two alignment targets overlap and turn green. When they turn green, the ES400 takes another picture.



Figure 8-3 *Successful Alignment*

5. Continue until five pictures are taken. The ES400 stitches the five pictures together and stores a panorama picture in memory.

Tap the icon at the bottom of the screen to stop stitching before taking five pictures or if stitching quality not favorable.

Camera Settings

Tap anywhere on the screen to display the camera Status bar and Control bar. The Status bar at the top of the screen provides camera setting information. The Control bar at the bottom of the screen provides function buttons to control the camera.

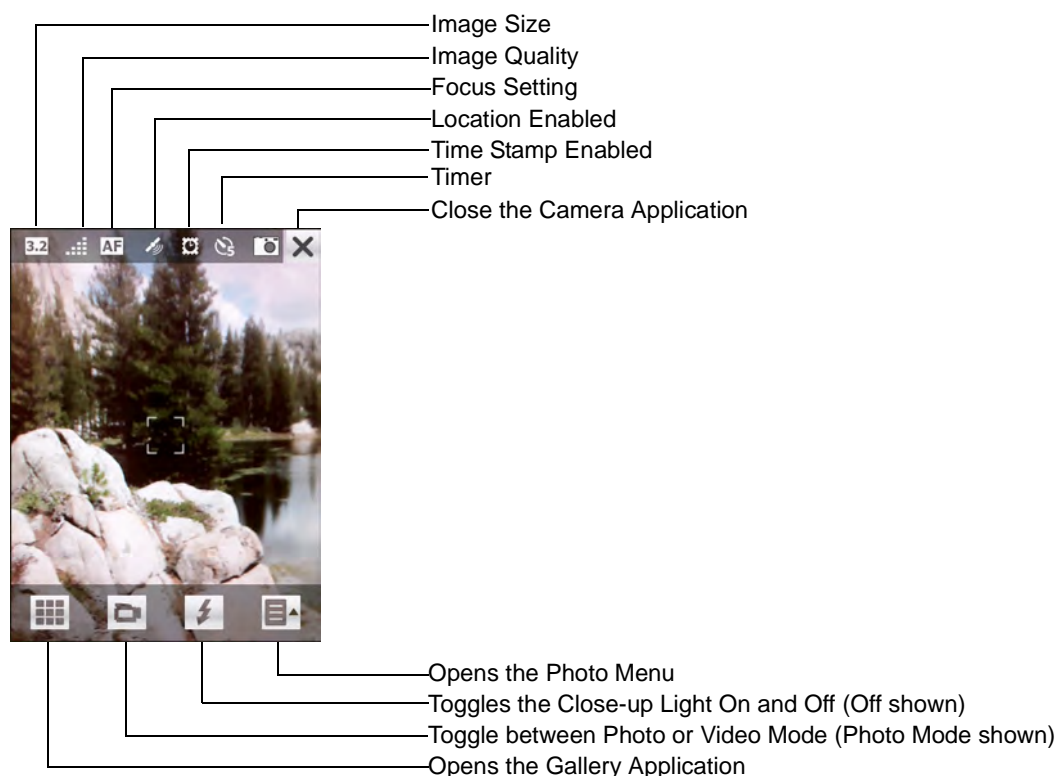

Figure 8-4 Camera Settings View

Camera Menu Options

Use the **Camera Menu** to configure the camera settings.

Size/Quality Settings

Use the **Size/Quality** settings to set the size and quality of the image. Tap the **Size/Quality** option to open the **Size/Quality** window.

Select one of the three yellow **Size** boxes to set the size of the image. The image can be set to three sizes:

- 1.3 Megapixels (1280 pixels x 1024 pixels)
- 2 Megapixels (1600 pixels x 1200 pixels)
- 3.2 Megapixels (2048 pixels x 1536 pixels).

Select one of the three yellow **Quality** boxes to set the quality of the image. The image can be set to three quality settings; **Low**, **Medium** and **High**.

Increasing the size and quality of the picture increases the size of the file saved on the ES400. The size of the file displays below the **Quality** boxes. Also listed is the number of pictures that can be stored on the ES400.

Panorama

Use the **Panorama** option to enable the camera to take panorama pictures. The Panorama feature allows the user to stitch multiple pictures together to form one wider picture. The stitching is done on the camera at the time of capture.

Tap the **Panorama** option to open the Panorama options window. Select one of the following:

Off - Disable Panorama feature.

Horizontal - Create a panorama picture by moving the ES400 to the right.

Vertical - Create a panorama picture by moving the ES400 down.

When in Panorama mode, the center cross-hairs become wider in proportion with the wider image that will result from the capture session.

Timer

Use the Timer option to control the delay between the shutter press and the image capture. Options are **Off**, **5 Sec.**, **10 Sec.**, **15Sec.** and **20 Sec.**

Advanced

Use the **Advanced** option to set additional camera options.

- **Workflow** - Use the Workflow option to customize the camera's behavior when taking pictures.
 - **Continuous** - The user does not view the picture just taken.
 - **Preview** - After the user takes a picture, it is briefly displayed on the screen before returning to camera mode. During the preview, tap the image to enter the image viewer mode.
 - **Edit** - After the user takes a picture, the user is brought to the image viewer mode to edit the picture.



NOTE In both Preview mode and Edit mode the user can press the Camera button to return to Image Capture mode.

- **Comment prompt** - Turns on reminders that comments have not been added to a particular picture or group of pictures.

If **After each photo** is enabled, in the Quick Review and the Image Viewer an Edit icon displays in the Status bar. Tap the Edit icon to open the **Photo Info** window.

If **When exiting** is enabled, a dialogue box appears prompting the user to add comments before exiting.

- **GPS location** - GPS coordinates can be used to tag pictures with coordinates for latitude and longitude. The camera application uses both GPS and WAN triangulation to acquire these coordinates.

If this feature is enabled but the ES400 cannot acquire coordinates from either GPS or WAN triangulation then the GPS no-signal icon  displays in the Status bar. Also, if the user has not enabled **Comment Prompts > After Each Photo** then a location prompt displays in the Status bar during the quick review stage informing the user that no coordinate data was attached saved.

The user can enable and disable the GPS coordinates feature by clicking on the GPS coordinates element in the advanced menu.

- **Storage** - Allows the user to either save the pictures to the ES400's built in memory or to a microSD card. Tap the **Storage** option to select either **Device** or **SD Card**. Note that the same feature exists in the **Video Capture** menu. These are intended to be independent settings. So, it is possible that a user could have pictures saved to the ES400's memory and videos stored on the microSD card.

- **Time/date stamp** - Allows the user to permanently place the time and date stamp onto the lower right corner of the picture. This is separate from the Time and Date as it appears in the metadata. Tap **time/date stamp** to toggle this feature on and off.

About

Displays the software version and end user license agreement.

Recording Video

Depending upon what mode was last used, either Camera mode or Video mode is enabled. The icon in the top right corner indicates the mode. If camera mode is enabled, tap anywhere on the screen to display the Status bar and then tap Video icon.

To record a video:

1. Point the ES400 at the subject.
2. Press the Camera button on the side of the ES400 or the Optical Nav Pad. The ES400 begins recording. A timer appears at the top of the screen indicating the running time of the video.
3. Press the Camera button or the Optical Nav Pad to end the recording and store it in memory.

Video Settings

The Status bar at the top of the screen provides video setting information. The Control bar at the bottom of the screen provides function buttons to control the video.

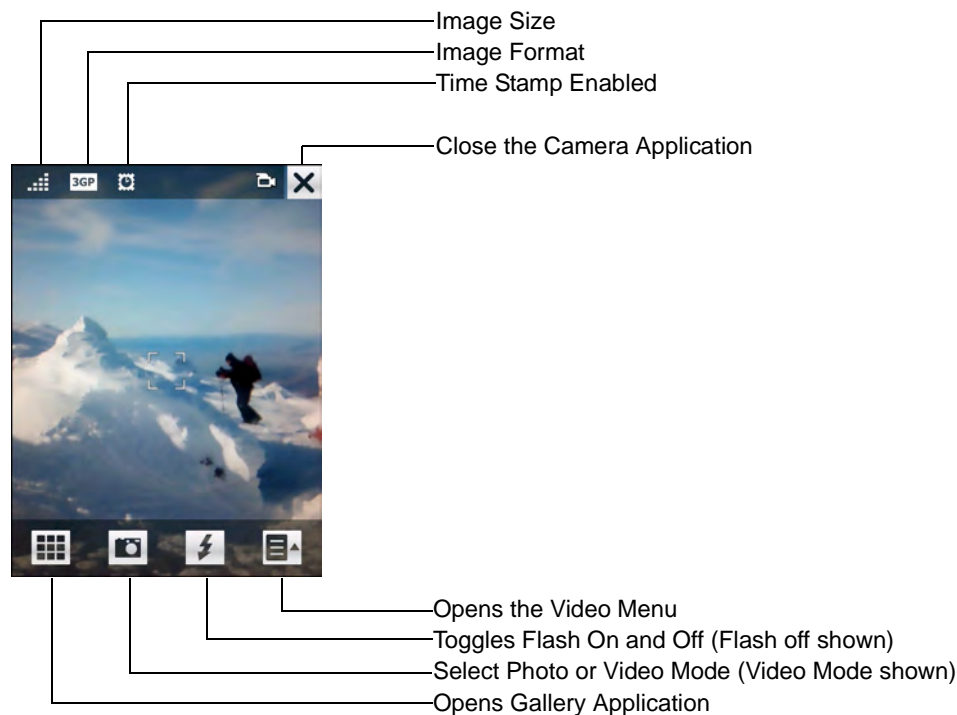

Figure 8-5 Video Settings

Video Menu Options

Use the **Video Menu** to configure the video settings.

Quality

Use the **Quality** option to set the resolution of the video capture:

- **QCIF** - Quarter Common Intermediate Format is a video format that has a data rate of 30 frames per second with each of those frames containing 144 lines and 176 pixels per line.
- **QVGA** - Quarter-VGA (QVGA) has an image resolution of 320 x 240 pixels or 240 x 320. QVGA is the common resolution for most phone video captures.
- **VGA** - Video Graphics Array (VGA) has an image resolution of either 640 x 480 (with 16 colors) or 320 x 200 (with 256 colors). The total palette of colors is 262,144.

Format

Use the **Format** option to set the format that the video is recorded in. Options: **MP4** or **3GP**.

Time/Date stamp

Use the **Time/Date stamp** option to add a time and date stamp to the video file.

Storage

Allows the user to either have the video saved to the ES400's built in memory or to a microSD card. Important to note is that the same feature exists in the **Photo** menu. These are intended to be independent settings. So, it is possible that a user could have images saved to the ES400's memory and videos stored on the microSD card.

About

Displays the software version and end user license agreement.

Viewing Pictures and Video

Use the **Gallery** to view pictures and videos stored on the ES400.

Press the Camera button on the side of the ES400. Tap the screen to display the Control bar and then tap the Gallery icon.

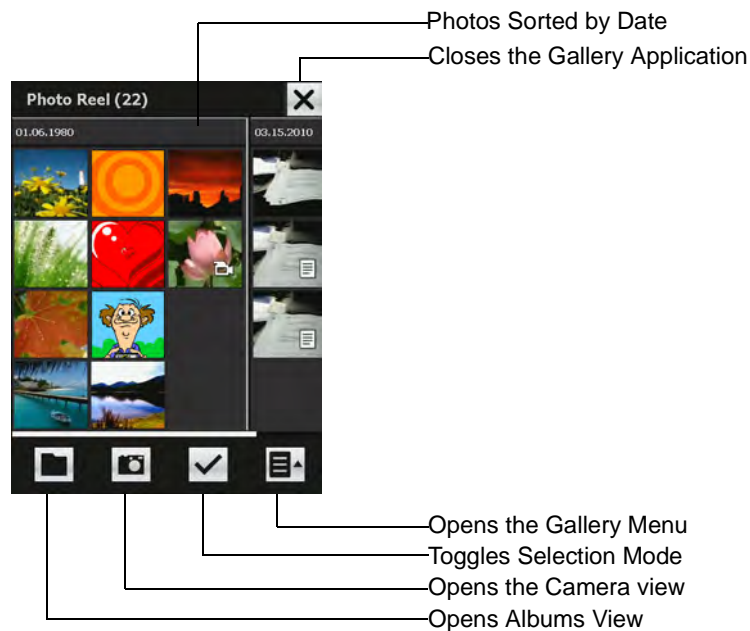

Figure 8-6 *Gallery Application*

The default view for the gallery displays the thumbnails by date. To view more thumbnails, slide the display to the left.

Albums

Tap the **Albums** icon to display the Albums view.

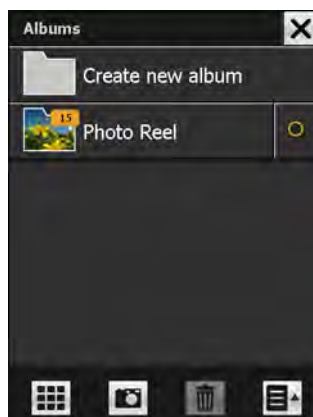

Figure 8-7 *Album View*

To create a new album, tap **Create new Album**.

Enter a name for the new album and tap **Save**.

Tap the album name to view the pictures in the album.

Select Mode

Allows the user to select one or more thumbnails from within the Gallery. Once selected, the menu options change to reflect actions that can be done to pictures or videos.

The following section details the menu options that become available once thumbnails have been selected.

To enter Selection Mode the user must tap the **Selection** icon from the Gallery Interface. Once pressed, the user may then select thumbnails by clicking on them. Thumbnails that have been selected are denoted by a color change.

Thumbnail Menu

After selecting one or more items, tap the Menu icon.

- **View/Edit Info** - Tap **View/Edit Info** to add location information and comments to the selected items. Tap **Save** when done.
- **Send** - Tap **Send** to send the selected items using email or MMS messaging.
Select **Via e-mail** to send the selected items through email. An Email message is created. Enter the email address of the recipient and then tap **Send**.
Select **Via MMS** to send the selected items through MMS messaging. An MMS messaging window appears. See [MMS Messaging on page 6-4](#) for information on creating an MMS message.
- **Move to Album** - Tap **Move to album** to move the selected items to another album. From the list, select the album to move the items to. The items are automatically moved to the new album.
- **Delete** - Tap **Delete** to delete the selected item from the memory.

Gallery Menu

Use the **Gallery Menu** to configure the Gallery.

- **Sort by** - Allows the user to sort the thumbnails within each Album by either date (default), location, size, photographer, image name, or album name (in Photo Reel only).
- **Filter by** - Allows user to filter media. Select All Media (default), Images Only or Video Only.
- **About** - Provides Gallery end-user license agreement.

Image Viewer

To view an image, tap the image thumbnail from the Gallery. The image opens in the Image Viewer.

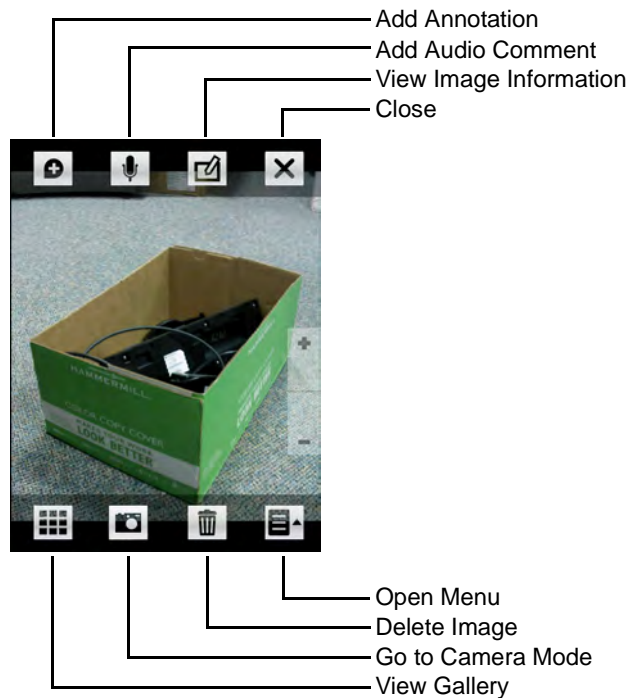

Figure 8-8 *Image Viewer*

Tap the screen to display the Status bar at the top of the screen and the Control bar at the bottom of the screen.

Annotating Images

The user can place marks permanently on the image.

1. Tap the screen to display the Status bar.
2. Tap the Annotation icon.



Figure 8-9 *Add Annotations*

3. To add a mark tap **Add** and then tap on a specific location on the image. A mark with the number **1** appears. The user can add as many marks as they like.
4. To remove a mark tap **Remove** and then tap one of the marks already on the image.

5. Tap **Save** to save the image with the marks or tap **Cancel** to discard the marks. Once the image is saved the marks are imbedded into the image and are no longer editable.

Audio Commenting

The user can add an audio recording to the image.

1. Tap the screen to display the Status bar.
2. Tap the **Audio Comment** icon.
3. Tap the record button. Speak into the microphone. Tap the End button when done.
4. Tap the **Play** button to listen to the recorded audio. Tap the **Delete** icon to delete the audio recording.
5. Tap **Save** to add the audio recording to the image or tap **Cancel** to discard the recording.

View or Edit Image Information

To view or edit the information about the image:

Tap the Info icon.

To edit the information, tap in a text box and enter data.

Tap **Save** to save the data or **Cancel** to close without saving the data.

Image Menu

The Image Menu provides setting for sending the image to other people, moving the image to another folder and configuring the annotation settings.

- **Send** - Tap **Send** to send the image using email or MMS messaging.
 - Select **Via e-mail** to send the image through email. An email message is created. Enter the email address of the recipient and then tap **Send**.
 - Select **Via MMS** to send the image through MMS messaging. An MMS messaging window appears. See [MMS Messaging on page 6-4](#) for information on creating an MMS message.
- **Move to Album** - Tap **Move to album** to move the image to another album. From the list, select the album to move the image to. The image is automatically moved to the new album.
- **Annotation Settings** - to set backup options for annotated items.
 - **Backup Original** - Turn this feature on to automatically make a backup copy of the original, unmarked image.
 - **Add Suffix to** - This Feature will allow the user to attach a suffix to the image filename of either the unmarked original or to the new image with the annotation marks on it. 'marked' is the default.
 - **Suffix Field** - Allows the user to customize the suffix that is added to either the marked or original image.

Video Viewer

To view a video, tap the video thumbnail from the Gallery. The video opens in the Video Viewer.

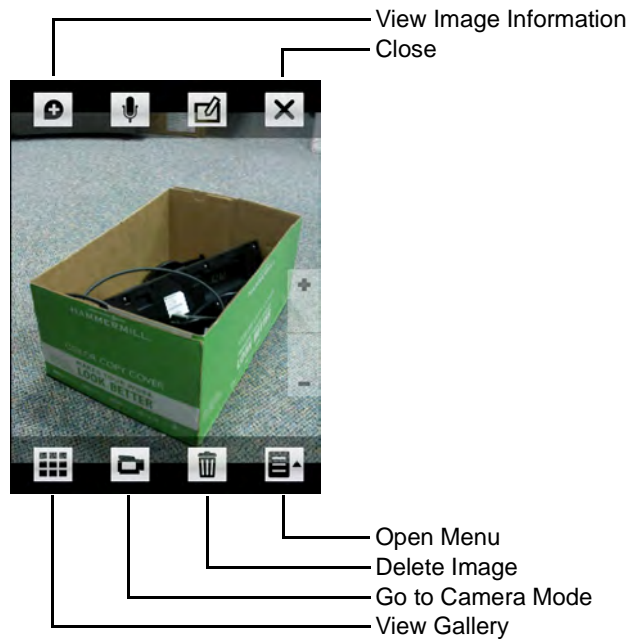

Figure 8-10 Image Viewer

Tap the screen to display the Status bar at the top of the screen and the Control bar at the bottom of the screen. The bars disappear after six seconds of inactivity.

View or Edit Video Information

To view or edit the information about the video:

1. Tap the Info icon.
2. To edit the information, tap in a text box and enter data.
3. Tap **Save** to save the data or **Cancel** to close without saving the data.

Video Menu

The Image Menu provides setting for sending the image to other people, moving the image to another folder and configuring the annotation settings.

- **Send** - Tap **Send** to send the image using email or MMS messaging.
 - Select **Via e-mail** to send the image through email. An Email message is created. Enter the email address of the recipient and then tap **Send**.
 - Select **Via MMS** to send the image through MMS messaging. An MMS messaging window appears. See [MMS Messaging on page 6-4](#) for information on creating an MMS message.
- **Move to Album** - Tap **Move to album** to move the image to another album. From the list, select the album to move the image to. The image is automatically moved to the new album.

Chapter 9 Bluetooth

Introduction

Bluetooth-equipped devices can communicate without wires, using frequency-hopping spread spectrum (FHSS) radio frequency (RF) to transmit and receive data in the 2.4 GHz Industry Scientific and Medical (ISM) band (802.15.1). Bluetooth wireless technology is specifically designed for short-range (10 meters (30 feet)) communication and low power consumption.

ES400s with Bluetooth capabilities can exchange information (e.g., files, appointments, and tasks) with other Bluetooth enabled devices such as printers, access points, and other Enterprise Smart Phones. To use the ES400 as a modem, create a dial-up modem connection between a computer and ES400.

Adaptive Frequency Hopping

Adaptive Frequency Hopping (AFH) is a method of avoiding fixed frequency interferers, and can be used with Bluetooth voice. All devices in the piconet (Bluetooth network) must be AFH-capable in order for AFH to work. There is no AFH when connecting and discovering devices. Avoid making Bluetooth connections and discoveries during critical 802.11b communications. AFH for Bluetooth consists of four main sections:

- Channel Classification - A method of detecting an interference on a channel-by-channel basis, or pre-defined channel mask.
- Link Management - Coordinates and distributes the AFH information to the rest of the Bluetooth network.
- Hop Sequence Modification - Avoids interference by selectively reducing the number of hopping channels.
- Channel Maintenance - A method for periodically re-evaluating the channels.

When AFH is enabled, the Bluetooth radio “hops around” (instead of through) the 802.11b high-rate channels. AFH coexistence allows Motorola Enterprise Smart Phones to operate in any infrastructure.

The Bluetooth radio in this ES400 operates as a Class 2 device power class. The maximum output power is 2.5 mW and the expected range is 10 meters (32.8 feet). A definition of ranges based on power class is difficult to obtain due to power and device differences, and whether one measures open space or closed office space.



NOTE It is not recommended to perform Bluetooth wireless technology inquiry when high rate 802.11b operation is required.

Security

The current Bluetooth specification defines security at the link level. Application-level security is not specified. This allows application developers to define security mechanisms tailored to their specific need. Link-level security occurs between devices, not users, while application-level security can be implemented on a per-user basis. The Bluetooth specification defines security algorithms and procedures needed to authenticate devices, and if needed, encrypt the data flowing on the link between the devices. Device authentication is a mandatory feature of Bluetooth while link encryption is optional.

Pairing of Bluetooth devices is accomplished by creating an initialization key that is used to authenticate the devices and create a link key for them. Entering a common PIN number in the devices being paired generates the initialization key. The PIN number is never sent over the air. By default, the Bluetooth stack responds with no key when a key is requested (it is up to user to respond to the key request event). Authentication of Bluetooth devices is based-upon a challenge-response transaction. Bluetooth allows for a PIN number or passkey that is used to create other 128-bit keys used for security and encryption. The encryption key is derived from the link key used to authenticate the pairing devices. Also worthy of note is the limited range and fast frequency hopping of the Bluetooth radios that makes long-distance eavesdropping difficult.

Recommendations are:

- Perform pairing in a secure environment
- Keep PIN codes private and don't store the PIN codes in the ES400
- Implement application-level security.

The Microsoft stack supports Smart-pairing. For detailed information, refer to the Microsoft MSDN.

Bluetooth Configuration

The following services are supported:

- OBEX Object Push Services
- Hands-Free Audio Gateway Services
- Serial Port Services
- Personal Area Networking Services
- PBAP Services
- Dial-Up Networking Services
- HID Client Services
- A2DP/AVRCP Services
- File Transfer profile
- General Audio/Video Distribution Profile
- SIM Access Profile
- Headset Profile
- Generic Object Exchange Profile
- Service Discovery Access profile

- Generic Access Profile.

COM2 through COM4, COM7 and COM8 are available unless being used by another service.

Bluetooth Power States

Suspend

When there is an active Bluetooth connection, the Bluetooth radio goes into low power mode maintaining the active connection.

✓ **NOTE** If there is an active Bluetooth connection between the ES400 and another Bluetooth device and there is no data activity, the ES400 will timeout. However, if the user presses the Power button on the ES400, the ES400 will suspend (except when on a call) and upon receiving data from a remote Bluetooth device, the ES400 will wake from suspend mode. For example, headset redial or Bluetooth scanner sending data to the ES400.

Resume

When the ES400 resumes, Bluetooth turns on if it was on prior to suspend.

Turning Bluetooth On and Off

Turn off the Bluetooth radio to save power or if entering an area with radio restrictions (e.g., an airplane). When the radio is off, other Bluetooth devices cannot see or connect to the ES400. Turn on the Bluetooth radio to exchange information with other Bluetooth devices (within range). Communicate only with Bluetooth radios in close proximity.

✓ **NOTE** To achieve the best battery life turn off radios not in use.

Enabling Bluetooth

To enable Bluetooth:

1. Tap **Status Bar** >  > **Bluetooth** > **Mode**.



Figure 9-1 Bluetooth Mode Tab

2. Check the **Turn On Bluetooth** checkbox.
3. Tap **OK**.

Disabling Bluetooth

To disable Bluetooth:

1. Tap **Status Bar** >  > **Bluetooth** > **Mode**.
2. Un-check the **Turn On Bluetooth** checkbox.
3. Tap **OK**.

Discovering Bluetooth Device(s)

The ES400 can receive information from discovered devices without bonding. However, once bonded, the ES400 and a bonded device exchange information automatically when the Bluetooth radio is on. See [Bonding with Discovered Device\(s\) on page 7-34](#) for more information.

To find Bluetooth devices in the area:

1. Ensure that Bluetooth is enabled on both devices.
2. Ensure that the Bluetooth device to discover is in discoverable and connectable modes.
3. Ensure that the two devices are within 30 feet (10 meters) of one another.
4. Tap **Status Bar** >  > **Bluetooth** > **Devices**.



Figure 9-2 *Bluetooth - Devices Tab*

5. Tap **Add new device**. The ES400 begins searching for discoverable Bluetooth devices in the area.
6. Select a device from the list.
7. Tap **Next**. The **Enter Passcode** window appears.
8. Enter the Passcode on the other device. The device is added to the Bluetooth list.

The user is prompted to enter a passcode. If the device has a specific passcode, enter it in the Passcode field and tap **Next**. If the device does not have a specific passcode, enter a passcode in the Passcode field and tap **Next**. The Bluetooth radio tries to connect with the device.

9. If the user created a passcode, the user is prompted by the other device to enter the same passcode. Enter the created passcode to establish a paired connection. (If the user entered a passcode from the device, the user shouldn't have to do anything on the other device.)
10. When the connection is complete, a list of matching and supported services on the device appears.
11. Select the services you want to use and tap **Finish**. The services on the new devices have to be selected or else the pairing won't include those services, even though the devices are paired. If services are not selected, the user is continually reprompted for the passcode from the device.
12. The device appears in the list on the main window.

After the passcodes have been accepted on both sides, a trusted ("paired") connection is established.

Available Services

✓ **NOTE** Some devices might not require a PIN. This depends upon the device's authentication.

The ES400 with Microsoft Bluetooth stack offers the following services:

- OBEX Object Push Services via Beam
- Hands-Free Audio Gateway Services
- Serial Port Services
- Personal Area Networking Services
- PBAP Services
- Dial-up Networking
- HID Client
- A2DP/AVRCP.

See the following sections for information on these services.

Object Push Services via Beam

✓ **NOTE** The user can only send files to a remote device using the Beam function.

Use the OBEX Push Service to send files and contacts to another Bluetooth device. To transfer files between the ES400 and another Bluetooth enabled device:

1. Ensure that Bluetooth is enabled and discoverable on both devices.
2. Ensure that the two devices are within 30 feet (10 meters) of one another.
3. Tap **My Apps > File Explorer**.
4. Navigate to the file to transfer.
5. Tap and hold on the filename until the pop-up menu appears.



Figure 9-3 File Explorer Window

6. Select **Beam File**. The ES400 searches for Bluetooth devices in the area.
7. Tap **Tap to send** next to the Bluetooth device to send the file to. The ES400 communicates with the device and sends the file. When completed, **Tap to send** changes to **Done**.

To transfer a contact between the ES400 and another Bluetooth enabled device:

1. Ensure that Bluetooth is enabled and discoverable on both devices.
2. Ensure that the two devices are within 30 feet (10 meters) of one another.
3. Tap **Contacts**
4. Navigate to the contact to transfer.
5. Tap and hold on the contact until the pop-up menu appears.
6. Select **Send Contact > Beam**. The ES400 searches for Bluetooth devices in the area.
7. Tap **Tap to send** next to the Bluetooth device to send the file to. The ES400 communicates with the device and send the contact. When completed, **Tap to send** changes to **Done**.

Internet Sharing

Internet Sharing allows the user to connect a computer or laptop to the ES400 and use the ES400 as a modem to connect to an office network or ISP.

To use ES400 as a modem using Bluetooth:

1. Ensure that the device is not connected to the computer or laptop.
2. On the ES400, ensure that the Phone is on and a data connection is configured.
3. Tap **Start > Internet Sharing**.
4. In the **PC Connection** list, select **Bluetooth PAN**.
5. In the **Network Connection** list, select the connection type.
Select the network connection that the device should use to connect to the Internet.
6. Tap **Connect**.
7. On the computer or laptop, setup a Bluetooth PAN with your device.

- a. Select **Start > Control Panel > Network Connections**.
- b. Under **Personal Area Network**, select **Bluetooth Network Connection**.
- c. Right-click on **Bluetooth Network Connection** and select **View Bluetooth** network devices.
- d. In the **Bluetooth Personal Area Network Devices** window select your device.
- e. Click **Connect**. The computer connects to the device via Bluetooth.

✓ **NOTE** If your computer is Bluetooth-enabled and you select Bluetooth as the PC connection, you must initiate and complete the Bluetooth PAN partnership before Internet Sharing will work. For more information, refer to Windows Help and Support.

8. To verify, on the PC or laptop, launch **Internet Explorer** and open a web site.
9. To end dial-up networking, on the ES400 tap **Disconnect**.

Hands-free Services

To connect to a Bluetooth headset:

✓ **NOTE** Newer Bluetooth headsets are device dependant and remember the last device they connected to. If problems occur while connecting to the headset, place the headset in discovery mode. Refer to the headset user manual for more information.

Only WAN audio and Voice Commander audio is routed to the headset. System audio is still emitted through the ES400 speaker.

You can accept calls and re-dial using the Hands-free profile.

Hands-free profile does not support 3-way calling.

1. Ensure that Bluetooth is enabled and discoverable on both devices.
2. Ensure that the two devices are within 30 feet (10 meters) of one another.
3. Tap **Start > Settings > Bluetooth > Devices**.
4. Tap **Add new device**. The ES400 searches for Bluetooth devices in the area.
5. Select the headset name and tap **Next**. The Passcode window appears.
6. Enter the headset's passcode, if required.
7. Tap **Next**. The ES400 connects to the headset. Refer to the headset user manual for instructions on communicating with a Bluetooth device.

Serial Port Services

Use the wireless Bluetooth serial port connection similar to a physical serial cable connection. Configure the application that will use the connection to the correct serial port.

To establish a serial port connection:

1. Ensure that Bluetooth is enabled and discoverable on both devices.
2. Ensure that the two devices are within 30 feet (10 meters) of one another.

3. Tap **Start > Settings > Bluetooth > Devices**.
4. Tap **Add new device**. The ES400 begins searching for discoverable Bluetooth devices in the area.
5. Select a device from the list.
6. Tap **Next**. The **Enter Passcode** window appears.
7. Enter the Passcode and the tap **Next**. The device is added to the Bluetooth list.
8. In the device list, tap the serial device. The **Partnership Settings** window displays.
9. Select the **Serial Port** checkbox.
10. Tap **Save**.
11. Tap **COM Ports** tab.
12. Tap **New Outgoing Port**. The add device window appears.
13. Select the serial device in the list and then tap **Next**.
14. Select a COM port from the drop-down list.
15. Tap **Finish**.

✓ **NOTE** No connection is made at this point. An application must open the selected COM port to trigger Microsoft Bluetooth stack to open the connection.

ActiveSync Using Bluetooth

Use the wireless Bluetooth serial port connection for ActiveSync similar to a physical USB cable connection. Configure the application that will use the connection to the correct serial port.

To set up a Bluetooth ActiveSync connection:

✓ **NOTE** For additional security, disable network bridging on the computer (specifically, bridging to a Remote NDIS adapter) before connecting to the computer to pass through to the Internet or a network. For more information on network bridging, see **Windows Help** on your computer.

The instructions below are for computers that support the Windows XP SP2 or later version operating system.

1. Ensure that Bluetooth is enabled and discoverable on both devices.
2. Ensure that the two devices are within 30 feet (10 meters) of one another.
3. On the computer, click **Start > Settings > Control Panel**.
4. Double-click **Bluetooth Devices**.
5. On the **Options** tab, select the **Turn discovery on** and **Allow Bluetooth devices to connect to this computer** checkboxes.

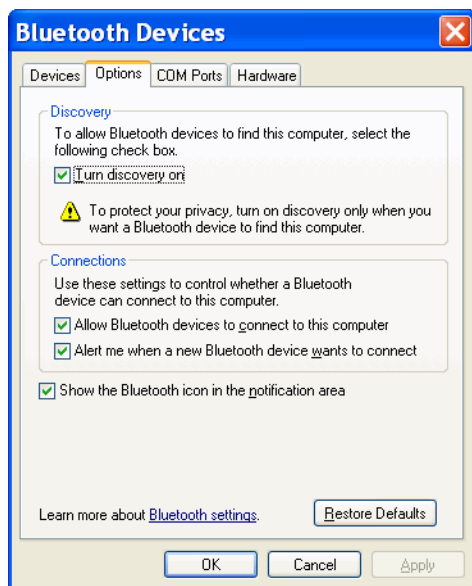

Figure 9-4 Computer Bluetooth Devices Window

6. On the **COM Ports** tab, click **Add**.
7. Select the **Incoming (device initiates the connection)** option, then click **OK**.
Note the number of the COM port that was added.
8. Click **OK**.
9. Click **Start > All Programs > Microsoft ActiveSync**.
10. Click **File > Connection Settings**.



Figure 9-5 ActiveSync Connection Settings

11. On the **Allow connections to one of the following** drop-down list, select the COM port with the number you noted earlier.
12. On the ES400, tap **Start > ActiveSync**.
13. Tap **Menu > Connect via Bluetooth**.
Synchronization is automatically initiated.

If an Authentication is required, the **Enter Passcode** screen appears, type an alphanumeric passkey (PIN code), then tap **Next**; enter the same passkey on the other device.

The passkey is recommended for enhanced security. The passkey must be between 1 to 16 alphanumeric characters.

If a passkey is not required, tap **Next**.

14. To disconnect the ActiveSync connection, tap **My Apps > ActiveSync**.
15. Tap **Disconnect**.

Phone Book Access Profile Services

Phone Book Access profile (PBAP) is used to synchronize contacts between a remote device and the ES400. To establish an PBAP synchronization:

1. Ensure that Bluetooth is enabled and discoverable on both devices.
2. Ensure that the two devices are within 30 feet (10 meters) of one another.
3. Tap **Start > Settings > Bluetooth > Devices**.
4. Tap **Add New Device**. The ES400 searches for a Bluetooth device, such as a car kit.
5. Select a device from the list.
6. Tap **Next**. The **Enter Passcode** window appears.
7. Enter the Passcode and the tap **Next**. The device is added to the Bluetooth list.
8. A dialog box appears requesting to transfer contacts to the car kit.
9. Select **Yes** or **No**.
10. If **Yes** is selected, contacts from the ES400 are transferred to the car kit.

Dial-Up Networking Services

Dial-up networking allows the user to connect a PC or laptop to the ES400 and use the ES400 as a modem to connect to an office network or ISP.

Before setting up dial-up networking, obtain dial-up information and other necessary settings (username, password and domain name, if required) for the office network or ISP. To create a new Bluetooth connection:

1. Ensure the ES400 is discoverable and connectable.
2. On the PC or laptop, set up Bluetooth according to the manufacturer's instructions.
3. On the PC or laptop Bluetooth software, search for the ES400 and select the Dial-up Networking service.
4. Using dial-up software on the PC or laptop, connect to the ES400.
5. The ES400 phone function dials the ISP number and connects to the ISP.
6. To verify, on the PC or laptop, launch Internet Explorer and open a web site.

Connect to a HID Device

The ES400 can connect to an Human Interface Device (HID) device such as a Bluetooth keyboard or mouse:

1. Ensure that Bluetooth is enabled on both devices.
2. Ensure that the Bluetooth device to discover is in discoverable and connectable modes.
3. Ensure that the two devices are within 10 meters (32.8 feet) of one another.
4. Tap **Start > Settings > Bluetooth > Devices**.
5. Tap **Add new device**. The ES400 begins searching for discoverable Bluetooth devices in the area.
6. Select a HID device from the list.
7. Tap **Next**. The **Enter Passcode** window appears. Refer to the device's User Manuals for more information.
8. Tap **Connect**. The ES400 connects to the HID device.

A2DP/AVRCP Services

A2DP/AVRCP is used to connect to a high-quality stereo headset:

1. Ensure that Bluetooth is enabled on both devices.
2. Ensure that the Bluetooth device to discover is in discoverable and connectable modes.
3. Ensure that the two devices are within 10 meters (32.8 feet) of one another.
4. Tap **Start > Settings > Bluetooth > Devices**.
5. Tap **Add new device**. The ES400 begins searching for discoverable Bluetooth devices in the area.
6. Select a stereo headset from the list.
7. Tap **Next**. The **Enter Passcode** window appears. Refer to the device's User Manuals for more information.
8. Tap **Connect**. The ES400 connects to the stereo headset.

For stereo headsets that can use hands-free services, connect to the hands-free service after connecting to the A2DP service:

1. Tap **Start > Settings > Bluetooth > Devices**.
2. Tap **Add new device**. The ES400 begins searching for discoverable Bluetooth devices in the area.
3. Select a stereo headset from the list.
4. Tap **Next**. The **Enter Passcode** window appears. Refer to the device's User Manuals for more information.



NOTE If Smart-pairing is configured and the device is requesting one of the pre-defined PINs, the **Enter Passcode** window does not appear.

5. Tap **Connect**. The ES400 connects to the stereo headset.

Chapter 10 Using GPS Navigation

Introduction

The ES400 includes Global Positioning System (GPS) technology. GPS technology is based on a worldwide system of GPS satellites orbiting the earth that continuously transmit digital radio signals. These radio signals contain data on the satellites' locations and their exact clock time and are used to determine your location on the earth.



WARNING! When using the ES400 in a vehicle, it is the user's responsibility to place, secure and use in a manner that will not cause accidents, personal injury or property damage or obstruct their view. It is the responsibility of the driver to operate the vehicle in a safe manner, maintain observation of all driving conditions at all times, and not become distracted by the device to the exclusion of safe driving practices. It is unsafe to operate the controls of the device while driving.

Software Installation

Third-party GPS navigation software is required. Evaluation software is available from various suppliers. For example; VisualGPS, visit: <http://www.visualgps.net/VisualGPSce/>

If interested in purchasing GPS navigation software check with the GPS software vendor (before purchasing, downloading, or installing any software) to determine that the application is compatible with the ES400. Refer to the application's user guide for application installation and setup information.

ES400 GPS Setup

The GPS-enabled ES400 automatically manages access to the GPS receiver to allow multiple programs to simultaneously access GPS data.

By default, the ES400 has the following settings:

1. Tap **Start > Settings > System > External GPS** icon.
2. In the **Programs** tab, the **GPS program port** is set to **COM6**.
3. In the **Hardware** tab, the **GPS hardware port** is set to **None**.

Operation

Acquiring satellite signals may take several seconds to a few minutes. It is best to be outside and have a clear, unobstructed view of the sky. Without a clear view, acquisition takes much longer and could result in the ES400 being unable to compute the initial position quickly. When operating the device indoors access to the GPS signals may be limited or unavailable.

- ✓ **NOTE** When using a GPS navigation application, ensure that the ES400 does not go into suspend mode. If the ES400 suspends then the power to the GPS radio is removed. Upon resume the GPS receiver must reacquire a valid GPS signal, resulting in a delay of positional information.

GPS Maps on microSD Cards

GPS navigation software vendors may sell maps on microSD cards. If using a microSD card with the GPS navigation software install the microSD memory card using procedure in [Installing a microSD Card on page 1-2](#).

Answering a Phone Call While Using GPS

If you receive a phone call while using your GPS navigation software:

1. Answer the phone call by pressing the **Answer** button.
2. Once you end the phone call, press the **End Call** button to resume the audio on the GPS software.

- ✓ **NOTE** Anytime you are using GPS on the ES400 and you receive a phone call, the audio on the GPS navigation software is muted until you finish the call.

Losing the GPS Signal While in a Vehicle

GPS performance on the ES400 may be affected if the vehicle has thermal glass windows and windshields, which can block the ES400 from receiving a GPS signal from satellites. To improve GPS signal strength, place the ES400 where there is a clear view of the sky. A direct line of sight is required between the ES400 and the GPS satellites to access information from the satellites.

Assisted GPS

GPS can be used in stand-alone or Assisted GPS (A-GPS) modes. A Stand-alone GPS receiver downloads data from GPS satellites. In certain environments, it can take several minutes to get a fix. By using GPS Location servers, A-GPS dramatically reduces the TTFF (Time To First Fix) and improves the sensitivity of GPS receivers by providing them with data that they would ordinarily have to download from the GPS satellites. With the A-GPS data, GPS receivers can operate faster and more reliably.

The **GPS Assist** application provides the ability to modify the settings associated with obtaining GPS data.

Tap **Start** > **Settings** > **Connections** > **GPS Assist**.

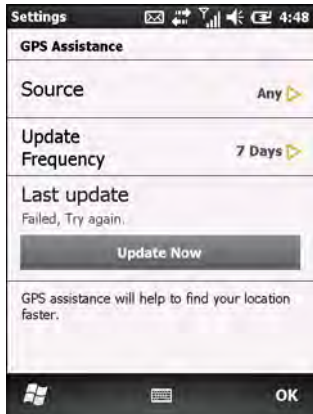

Figure 10-1 *GPS Assistance Window*

To set the source of the data tap **Source** and select one of the options: WAN (default), WLAN, Active Sync, Any, None.

To set the frequency of updating the data tap **Update Frequency** and select one of the options: On Demand (default), 1 Day, 2 Days, 4 Days, 7 Days.

To manually update the data tap the **Update Now** button.

Chapter 11 Settings

Introduction

This chapter provides information for customizing the ES400.

Settings Folder

Table 11-1 lists applications pre-installed on the ES400. Tap **Status Bar** >  or tap **Start** > **Settings** to open the **Settings** tab.

Table 11-1 *Setting Applications*











Icon	Description	Icon	Description
	Bluetooth - Turn on Bluetooth, set the ES400 to visible mode and scan for other Bluetooth devices in the area.		Lock - Set a password for the ES400.
	Clock & Alarms - Set the device clock to the date and time of your locale. Alarms can also be set at specified days and times of a week.		Power - Check battery power and set the time-out for turning off the display to conserve battery power.
	Home - Customize the appearance of the Home screen and the information to display on it.		Sounds & Notifications - Enable sounds for events, notifications, and more, and set the type of notification for different events.
	Connections Folder - Contains connection setting applications.		System Folder - Contains system setting applications.
	Personal Folder - Contains personal setting applications.		Microsoft My Phone - Synchronizes the phone's contacts, calendar, tasks, text messages, music, photos, videos and other documents with your My Phone account at www.microsoft.com .

Table 11-1 Setting Applications (Continued)



































Icon	Description	Icon	Description
	Lock Switch - Switch between use of Microsoft locking feature or the Motorola locking feature. Refer to Locking the ES400 on page 11-3 .		
Connections Folder			
	Beam - Set the ES400 to receive incoming beams.		Domain Enroll - Make your device an AD domain member for device management and security.
	Connections - Set up one or more types of modem connections for your device, such as phone dial-up, cellular, Bluetooth, and more, so that the ES400 can connect to the Internet or a private local network.		Phone Network Setup - Configure the ES400 network.
	GPS Assist - Modify the settings associated with using other data sources to aid in finding a location.		USB Connect - Configure USB communication port. Refer to ActiveSync on page 12-11 .
	Wi-Fi - Setup wireless network connection and customize settings.		Wireless Manager - Enables or disables the ES400's wireless radios and customizes Wi-Fi, Bluetooth and Phone settings.
Personal Folder			
	Buttons - Assign a program to a button.		Holster - Configure ES400 behavior when placed in the holster.
	KeyRemap - Remap keypad keys to characters or applications.		Nav pad - Set the function of the optical Nav Pad.
	Phone - Configure the phone.		Owner Information - Enter personal information on the ES400.
	Voice Commander Settings - Configure the Voice Commander application.		Dialer Switcher - Switches between the Microsoft dialer and the Enterprise Dialer.
System Folder			
	About - View basic information such as the Windows Mobile® version and type of processor used on the ES400.		Accelerometer - Configure how the ES400 behaves. Refer to Accelerometer on page 11-11 .
	Backlight & Keylight - Set backlight and keylight settings. Refer to Backlight and Keylight Settings on page 11-10 .		Certificates - See information about certificates installed on the ES400.

Table 11-1 Setting Applications (Continued)

Icon	Description	Icon	Description
	Customer Feedback - Submit feedback on the Windows Mobile 6 software.		Encryption - Allow files on a storage card to be encrypted. Encrypted files are readable only on your device.
	Device Information - Displays the ES400's software and hardware information.		Error Reporting - Enable or disable the Microsoft's error reporting function.
	External GPS - Set the appropriate GPS communication ports, if required. Refer to ES400 GPS Setup on page 10-1 .		Memory - Check the device memory allocation status and memory card information and stop currently running programs.
	Master Reset - Resets the ES400 to default settings. Refer to Master Reset on page 11-15 .		Regional Settings - Set the regional configuration to use, including the format for displaying numbers, currency, date, and time on the ES400.
	Managed Programs - Displays the programs that were installed on the ES400 using Mobile Device Manager.		Remove Programs - Remove programs that you installed on the ES400.
	Screen - Change the screen orientation, re-calibrate the screen, and change the screen text size.		System Info - Obtain system information.
	Task Manager - Stop running programs.		DataWedge - Enable data capture using the camera.

Locking the ES400

There are two types of locking features available; the standard Microsoft Lock and Lock Plus.

✓ **NOTE** The user can make emergency calls even when the ES400 is locked.

Switching Between Microsoft Lock and Lock Plus

To select either the Microsoft Lock or Lock Plus:

1. Tap **Start** > **Setting** > **Lock Switch**.
2. Select either **Lock Plus** for fingerprint and pin security or **Microsoft Lock** for pin security.
3. Tap **Save** and then tap **OK**.

Lock Plus Setup

Use **Lock Plus** to set up a password or enroll fingerprints to un-lock the ES400.

Tap **Start > Settings > Lock**.

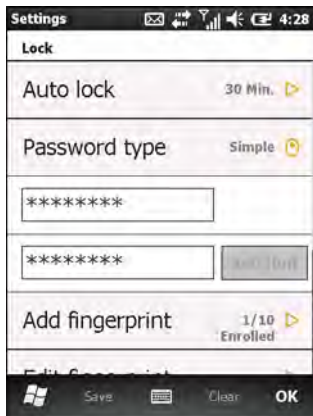

Figure 11-1 Lock Plus Settings Window

Tap **Auto lock** to select an inactivity timeout period before the ES400 locks, and tap **OK**. (If **Disabled** is selected, the ES400 will not auto-lock.)

Password Locking

✓ **NOTE** If the device is configured to connect to a network, use a strong (difficult to figure out) password to help protect network security. Password cracking tools continue to improve and the computers used to crack passwords are more powerful than ever.

1. Tap **Password type** to toggle between simple and strong password type.
2. For a simple password:
 - a. enter a four-digit password in the **Password** field.
 - b. Re-enter the password in the **Confirm:** field.
 For a stronger password:
 - c. Enter a seven character password in the **Password:** field. A strong password must contain at least seven characters and contain at least three of the following: uppercase and lowercase letters, numerals, and punctuation.
 - d. Re-enter the password in the **Confirm:** field.
3. To set a hint to remember the password, tap the **Hint** button and then enter a hint for a password reminder.
4. Tap **Save** and then tap **Yes**.

Finger Swipe Locking

To enable device un-locking using a fingerprint swipe:

1. Tap **Add fingerprint**.



Figure 11-2 *Add Fingerprint Window*

2. Pull the tip of a finger across the fingerprint reader in a downward motion (toward the camera lens) or an upward motion (toward the Power button) starting at the bottom of the fingerprint.
or
Push the tip of a finger across the fingerprint reader in an upward motion (toward the Power button) or a downward motion (toward the camera lens) starting at the top of the fingerprint.
3. When the fingerprint is read successfully, a green fingerprint appears in the first box. If the fingerprint is read unsuccessfully, a red fingerprint appears in the box.
4. Repeat swiping the finger two more times.
5. Upon successful reading, a template is created. Swipe the finger one more time to verify the template.
6. Once the fingerprint is enrolled, tap **Save** and then **OK**.

Editing Fingerprint Swipes

To change or edit the enrolled fingerprint:

1. Tap **Edit fingerprint**.
2. Select the fingerprint to edit.
3. In the text box, change the name associated with this fingerprint.
4. Tap **Change fingerprint** to edit the fingerprint data.
5. Swipe a new fingerprint.
6. Tap **Program launched** to select a program to automatically launch when a particular fingerprint is swiped.

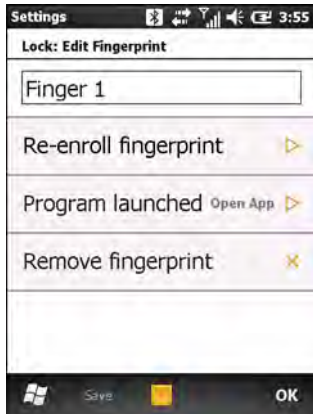

Figure 11-3 *Edit a Fingerprint*

7. To remove a fingerprint tap **Remove fingerprint**.
8. Tap **Yes** and **OK** to confirm the changes.

Edit Lock Screen Display

To change the information that appears on the Lock screen:

1. Tap **Lock screen options**.

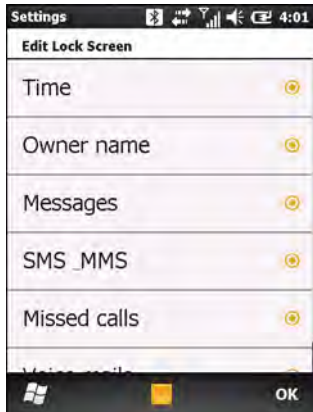

Figure 11-4 *Lock Screen Options Window*

2. Select items to display on the Lock screen.
3. Tap **OK** when done.

Audio Feedback

To enable an audio sound upon a successful finger swipe:

Tap **Audio feedback** to toggle audio on and off.

Microsoft Locking

Locking the ES400 turns off keyboard and touch screen functionality. This is helpful when the ES400 is turned on and you want to prevent accidental key presses.

To lock the ES400, tap **Start** > . The lock screen appears.

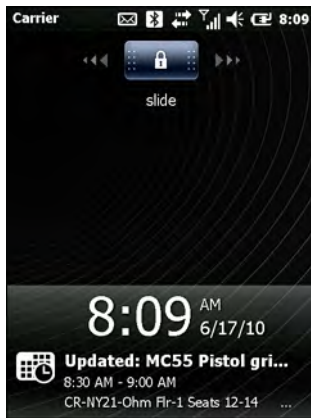

Figure 11-5 Lock Screen

Drag  to either the right or left side of the screen.

If a password is set up, enter the password and then tap  to unlock and display the Home screen, tap  to unlock and display the Contacts window, tap  to unlock and display the Messaging window.

Password Locking Setup

Use the **Password** window to set a password to disable unauthorized access to the ES400.

✓ **NOTE** If the device is configured to connect to a network, use a strong (difficult to figure out) password to help protect network security. Password cracking tools continue to improve and the computers used to crack passwords are more powerful than ever.

1. Tap **Start** > **Settings** > **Lock** > **Password**.
2. Select **Prompt if device unused for** check box to enable password protection.
3. From the drop-down list, select a time value for the protection to take affect after non-use.
4. From the **Password type:** drop-down list, select either **Simple PIN** or **Strong alphanumeric**.
5. For a simple password, enter a four-digit password in the **Password** field.
For a stronger password:
 - a. Enter a seven character password in the **Password:** field. A strong password must contain at least seven characters and contain at least three of the following: uppercase and lowercase letters, numerals, and punctuation.
 - b. Re-enter the password in the **Confirm:** field.
6. Tap **OK**.

Switching the Dialer

The ES400 provide an Enterprise Dialer user interface and the standard Microsoft interface.

To switch between the Enterprise Dialer and the Microsoft Dialer:

1. Tap **Start > Settings > Personal > Dialer Switcher**.
2. Select either **Enterprise Dialer** or **Microsoft Dialer**.
3. Tap **Save**.
4. Tap **OK**. The ES400 reboots.

Device Management Window

The Device Management window provides quick and easy access to common settings and related options. The Device Management window is accessed by tapping anywhere on the **Status Bar**.

Sound Profiles

To create a new sound profile or to edit a custom profile:

1. Tap **Status Bar > **.
2. Tap **>** next to a custom profile or tap **Create New** to create a new profile.

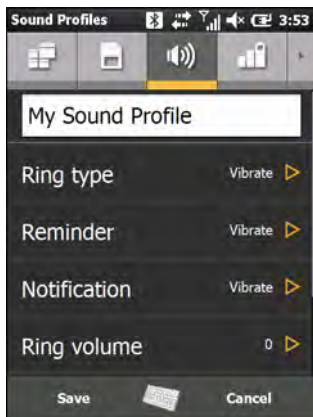

Figure 11-6 *Sound Window*

3. Edit or enter a new name for the profile in the text box.
4. Select each feature listed and select an available option.
 - **Ring type** - Set the type of ring that occurs when an incoming call is received.
 - **Reminder** - Set the type of ring that occurs when a ES400 generates a reminder.
 - **Notification** - Set the type of ring that occurs when a notification is received.
 - **Ring volume** - Set the volume of the ring.
 - **System volume** - Set the volume of the system audio.

- **Ringtone** - Set the ringtone for an incoming call.

5. Tap **Save** to save the changes to the profile.

To delete a custom sound profile:

1. Tap **>** next to the custom profile.
2. Tap **Delete Profile** and then tap **OK**.

Power Profiles

To create a new or edit a custom power profile:

1. Tap **Status Bar** > .
2. Tap **>** next to the current profile.
3. Tap **>** next to the a profile to edit or tap **Create New** to create a new profile.

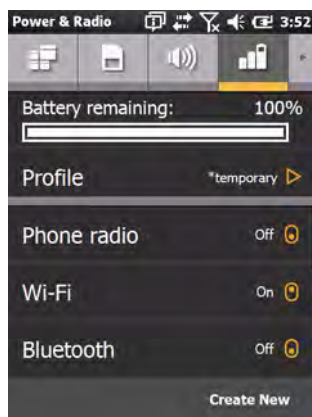



Figure 11-7 *Edit Profile Window*

4. Edit or enter a new name for the profile in the text box.
5. For each radio, tap the name to toggle the value to **On** or **Off**.
 - Phone radio
 - Wi-Fi
 - Bluetooth.
6. Scroll down to view more options.
7. Tap the option to select each feature listed and select an available option.
 - **Device timeout** - Sets the amount of time after inactivity that the ES400 goes into suspend mode.
 - **Backlight** - Sets the amount of time after inactivity that the ES400 goes into suspend mode.
 - **Brightness** - Sets the screen brightness to automatic or manual. If selecting manual, set the brightness level using the slider.
 - **ActiveSync (Peak Time)** - Sets the interval between which the ES400 checks for email and calendar events during peak times.

8. **ActiveSync Off (Off-peak Time)** - Sets the interval between which the ES400 checks for email and calendar events during off-peak times. Tap **Save**.

Alarms

To use the ES400 as a clock:

1. Tap the **Status Bar** >  > **Edit Alarm**.
2. Tap one of the three alarm rows.
3. Use the time field up and down arrows to set the time.
4. Highlight the **Description** field, then enter a name for the alarm.
5. Tap the letter(s) representing the day(s) of the week to enable the alarm.
6. From the drop-down list, select the sound that plays when the alarm starts. Tap **Play** to listen to the alarm sounds and tap **Stop** to cancel playback.
7. From the drop-down list, select the repeat sound notification type.
8. Tap **OK**.
9. Set up to two more alarms.
10. Select the checkbox to enable the alarm sound even when the ES400 is set to silent or vibrate.
11. Tap **OK**.

Backlight and Keylight Settings

The display brightness settings provides the ability to automatically detect the brightness in a specific environment.

1. Tap **Start** > **Settings** > **System** > **Backlight & Keylight**.
2. Use the **Battery Power** tab to set the backlight and keylight settings when the ES400 is on battery power.
3. Use the **External Power** tab to set the backlight and keylight settings when the ES400 is on external power.
 - **Backlight** - Set the backlight functionality. Select **On Any Input** to turn on the backlight upon an action or touch of the screen. Select **Always On** to keep the backlight on all the time.
 - **Backlight Timeout** - Sets the time of inactivity before the screen backlight turns off.
 - **Backlight Brightness** - Select between automatic and manual control. Select Auto to automatically control the backlight. Select Manual set the backlight brightness. Select one of five levels of brightness.
 - **Keylight** - Select **On Any Input** to turn on the keylight upon an action or touch of the keypad. Select **Always On** to keep the keylight on all the time. Select **Follow Display** to set the Keylight to follow the same settings as the backlight.
 - **Keylight timeout** - Sets the time of inactivity before the keylight turns off.

Accelerometer

The user has the ability to set behaviors when the ES400 is in motion, has a certain orientation or if the device is face down.

Display Tab

Use the **Display** tab to set the ES400 behaviors and to set the ES400 to automatic operations.

Tap **Start > Settings > System > Accelerometer**.

- **Suspend when face down** - Places the ES400 in suspend mode when it is placed face down.
- **Screen rotation** - Enable or disable screen rotation. The screen can be rotated between portrait and landscape modes automatically, depending on the physical orientation of the ES400. For example, if the ES400 is rotated 90° counterclockwise, the display rotates counterclockwise 90°.

About Tab

Use the **About** tab to view accelerometer information.

Optical Nav Pad

The ES400 uses two types of cursors for navigating on the screen:

- 4-way
- Cursor.

To change the functionality of the Optical Nav Pad, tap **Start > Settings > Personal > Nav Pad**.

Select the **Navigation mode** of the Optical Nav Pad. Either **4-Way** or **Cursor**.

The **Sensitivity** control appears when the 4-Way is selected. Select the **Sensitivity** bar and select the sensitivity level.

The Speed control appears when **Cursor** is selected. Select the Speed bar and select the mouse speed level.

Select **Cursor timeout** to control the time that the cursor displays after inactivity.

Key Remapping

The **KeyRemap** application provides the ability to remap hardware keys to characters and applications. To open the **KeyRemap** application tap **Start > Settings > Personal > KeyRemap**.

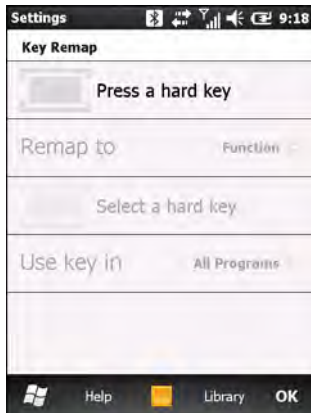

Figure 11-8 *Key Remap Window*

Remap a Key to a Program

To remap a key to a program:

1. Press the key on the keypad to remap.
2. Tap **Remap to**.

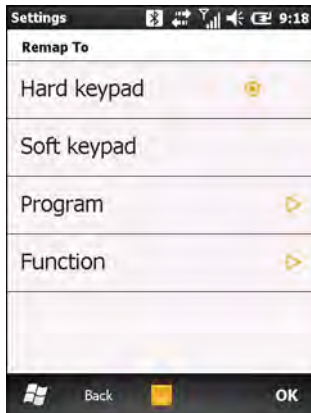

Figure 11-9 *Remap To Window*

3. Tap **Program**.
4. From the program list, select a program.
5. Tap **Save** and then tap **OK**.

Remap a Key to a Character

To remap a key to a character:

1. Press the key on the keypad to remap.

2. Tap **Remap to**.
3. Tap **Hard keypad**.
4. On the keypad, select a key to remap to.
5. Tap **Use key in**.
6. Select **All Programs** or a specific program that the key remap will function in.
7. Tap **Save** and then tap **OK**.

Remap a Key to a Function

To remap a key to a function:

1. Press the key on the keypad to remap.
2. Tap **Remap to**.
3. Tap **Function**.
4. From the Function list, select a function. Scroll down to see all options.
5. Tap **OK**.
6. Tap **Use key in**.
7. Select **All Programs** or a specific program that the key remap will function in.
8. Tap **Save** and then tap **OK**.

Remap a Key to a Character Using the Soft Keypad

To remap a key to a soft keypad character:

1. Press the key on the keypad to remap.
2. Tap **Remap to**.
3. Tap **Soft keypad**. The soft keypad appears.



Figure 11-10 *Select Character in the Soft Keypad*

4. Select a character from the soft keypad.

5. Close the soft keypad.
6. Tap **Use key in**.
7. Select **All Programs** or a specific program that the key remap will function in.
8. Tap **Save** and then tap **OK**.

Remap Simultaneous Keys

To remap simultaneous key presses:

1. Press the first key and then the second key. For example, Press the **fn** key and then the P key. The @ symbol appears.
2. Tap **Remap to**.
3. Select the remap to feature.

Editing a Remap Key

To edit an existing remapped key:

1. Tap **Library**.

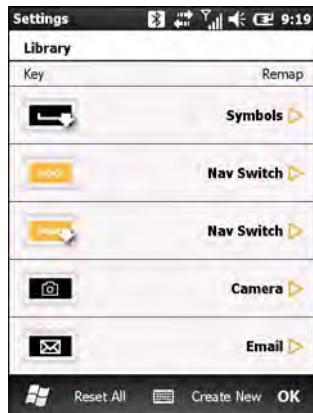

Figure 11-11 Library Window

2. Select the remapped key to edit.
3. To change the key remapping to another key, follow the instructions detailed above. To reset the remapped key to the default value, tap **Reset Key**.
4. Tap **Yes** to reset to the default state or **Cancel** to keep the current remap state and then tap **OK**.

To reset all remapped keys to the default state:

1. Tap **Library**.
2. Tap **Reset All**.
3. Tap **Yes** to reset to the default state or **Cancel** to keep the current remap state and then tap **OK**.

Master Reset

Use the Master Reset application to restore the ES400 to the default settings and remove personal information. Data on the SIM card and microSD card is not deleted.

To reset the ES400:

1. Tap **Start > Settings > System > Master Reset**.



Figure 11-12 *Master Reset Window*

2. Tap **Reset**.
3. Enter 1111 in the text box.
4. Tap **Reset** tile to delete all user data and restore default settings or tap **Cancel** tile to exit without deleting the data.

Program Shortcuts Setup

To change program shortcuts:

1. Tap **My Apps > Edit > Dock**.



Figure 11-13 *Add Shortcut Icon*

2. Tap a shortcut button to remove the assigned shortcut.
3. Tap a new program icon and then tap **Save**.

My Apps Window Setup

To create a customized application list:

1. Tap **My Apps > Edit > View > Create New**.
2. In the text box, enter a name for the list.
3. Scroll through the list and tap an icon to add to the new list. Each icon highlights indicating it is selected.

As icons are added to the list, the icon counter increments.



Figure 11-14 *Add Programs*

4. Tap **Save**.

To make the new list the default, tap the name of the list.

To edit a customized application list:

1. Tap **My Apps > Edit > View**.
2. Tap  next to the list to edit.
3. Tap an icon to add or delete from the list.
4. Tap **Save** and then tap **OK**.

Card Setup

The cards on the Motorola Home screen can be configured and re-ordered.

On any card, tap  to flip the card over.

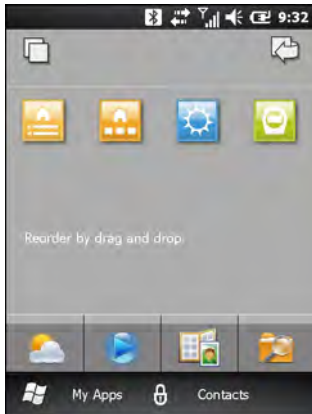



Figure 11-15 *Back of Card*

Re-Order Cards

Each icon on the card back represents a card. To re-order the cards, press and hold an icon and then drag it to a new location. Tap  to return to the front of the card.

Configure Cards

Cards can be removed so that they do not appear on the Home screen.

On any card, tap  to flip the card over.

Tap  to configure the cards.

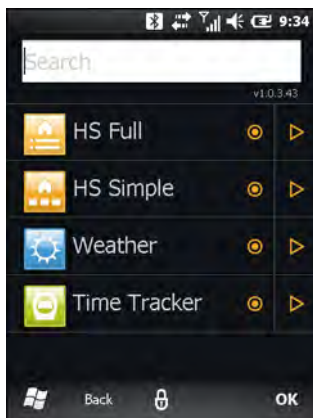





Figure 11-16 *Card Configuration Window*

The window lists the available cards. A  next to the name indicates that the card is enabled. A  indicates that the card is disabled.

1. Tap the name of the card to enable or disable the card.

2. Tap  to view a description of the card.
3. Tap **OK** to return to the Home screen.

Weather Card Setup

The Weather card displays the current weather for your location plus the next three days provided by Accuweather.com. Tap  to manually update the data.



Figure 11-17 *Weather Card*

Add a New Location

To add a new location:

1. Tap the Setting icon.
2. In the text field, enter a city or zip code.
3. Tap the Magnifying Glass icon.
4. Select the new location from the list.
5. Tap Back to return to the Weather card front.

Change Location

To change the location:

1. Tap the Settings icon.
2. Select a location from the list.

Delete a Location

To delete a location:

1. Tap the Settings icon.
2. Scroll to the desired location.
3. Tap the X. The location is removed from the list.
4. Tap **Back** to return to the Weather card front.

Time Tracker Setup

The Time Tracker card is an application that keep track of time spent on projects. Project data is stored in the /Windows directory in file *TimeTracker_data_file.csv*.

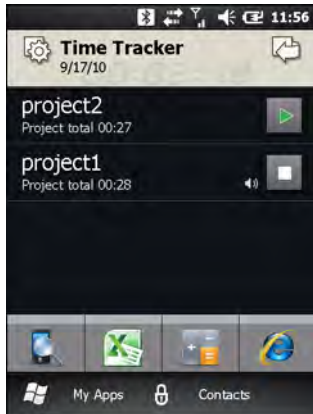

Figure 11-18 *Time Tracker Main Screen*

1. To create a new project, tap the **Settings** icons.

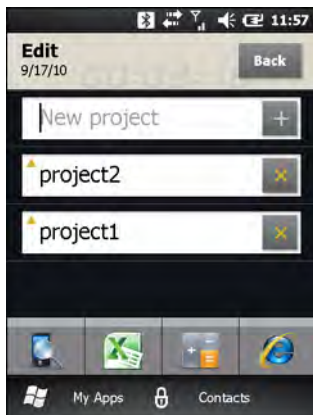

Figure 11-19 *New Project*

2. In the text box, enter the project name.
3. Tap + to add the project to the list.
4. Tap **Save**.
5. In the main screen, tap the project name to open the project screen.

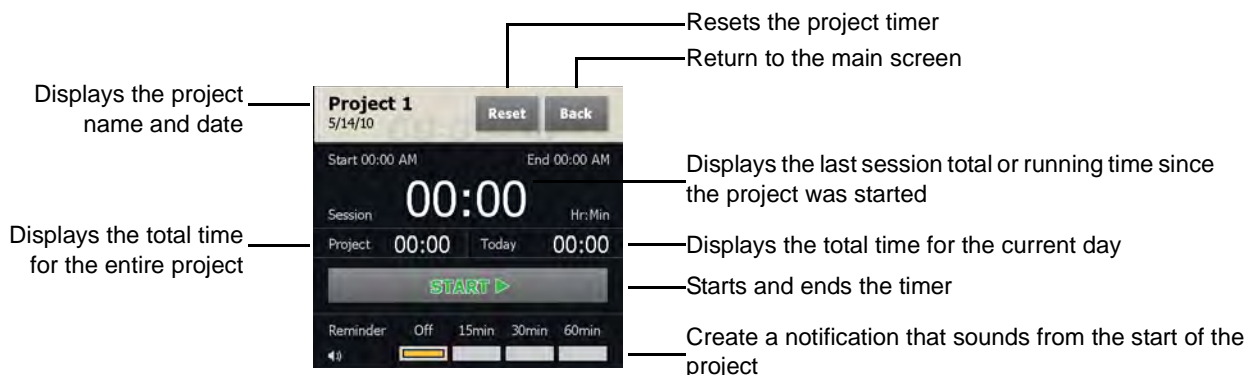

Figure 11-20 Project Screen

6. Tap the **Start** button to start the project timer.
7. Select a reminder time that will indicate the interval from the start of the project session.
8. Tap **Back** to return to the main screen.

Email Setup

The ES400's **Messaging** application lets users access and manage multiple email accounts simultaneously in one convenient location. To send and receive email messages through an ISP (Internet Service Provider) account, or to use the ES400 to access corporate email through a VPN (Virtual Private Network), first set up an IMAP or POP account.

- IMAP (Internet Message Access Protocol) - This mail retrieval protocol is frequently used in large networks and commercial and institutional settings. IMAP4 is the current standard.
- POP (Post Office Protocol) - This protocol is supported by most ISPs and is currently more common among consumer applications. POP3 is the current standard.

✓ **NOTE** If you have multiple email accounts, configure each account with its own settings.

Setting Up an IMAP or POP Account

When setting up an IMAP or POP account, the ES400 may be able to retrieve account settings automatically, or you may need to enter certain settings manually.

Automatic Email Setup

1. Press .
2. Tap **Setup E-mail**.
3. In the **E-mail address** text box, enter an email address.
4. In the **Password** text box, enter an associated password.

- The **Save password** checkbox is checked by default to allow the ES400 to always remember the email account password. To prevent other users from viewing the email account, tap the **Save password** checkbox to remove the checkmark and deactivate the feature.

- Tap **Next**.



NOTE For some common email types, the ES400 automatically detects and configures the email settings without performing this step.

- Tap the **Try to get e-mail settings automatically from the Internet** checkbox to place a checkmark in the checkbox.

Tap **Next** to attempt to retrieve these settings automatically. This process may take several minutes. The ES400 attempts to determine the necessary communication settings for both incoming and outgoing email messages.

- If the ES400 was able to automatically retrieve the necessary settings, tap **Next**.

If the ES400 was unable to obtain the settings automatically, tap **Next** and proceed to step 8 in [Entering Email Settings Manually on page 11-22](#).

- In the **Your name:** field, enter the name that displays in the **From** field on outgoing messages.

- In the **Account display name:** field enter a name for the new email account.

This name appears within the list of available email accounts on the E-mail page.

- Tap **Next**.

- Tap the **Automatic Send/Receive:** field and select the time interval you would like for the ES400 to send and check for new email messages.

- Tap the **Review all download** settings link for additional download settings and options. See [Editing an Email Account on page 11-24](#) for more details.

- Tap **Finish**.

Manual Email Setup

If the Automatic configuration was unsuccessful, or if accessing an account using a VPN server connection, contact your ISP (Internet Service Provider) or network administrator for the following information and enter it manually:

- Account type (IMAP4 or POP3)
- Incoming and outgoing mail server names
- Username and password
- Domain name
- Special security settings (if used).

For more information about configuring email accounts, go to:

www.microsoft.com/windowsmobile/help/smartphone/default.msp or www.windowsmobile.com/getstarted

Entering Email Settings Manually

- Press .

2. Tap **Setup E-mail**.
3. In the **E-mail address:** field, enter the email address for the account.
4. In the **Password:** fields and the password for the account.
5. The **Save password** checkbox is checked by default to allow the ES400 to always remember the email account password. To prevent other users from viewing your email, tap the **Save password** checkbox to remove the checkmark and deactivate the feature.
6. Tap **Next**.
7. Tap the **Try to get e-mail settings automatically** from the Internet box to remove the checkmark from the box and tap **Next**.
8. In the **Your e-mail provider:** drop-down list, select **Internet e-mail** and tap **Next**.
9. In the **Your name:** field enter the name that will display in the **From** field on outgoing messages.
10. In the **Account display name:** field enter a name for this new email account.
This name appears within the list of available email accounts on the E-mail page.
11. Tap **Next**.
12. In the **Incoming mail server:** field enter the incoming mail server address.
13. In the **Account Type:** drop-down list, select either **POP3** or **IMAP4**.
14. Tap **Next**.
15. In the **User name:** field enter the username for the account.
16. In the **Password:** field enter the password for the account.
17. Tap **Next**.
18. In the **Outgoing (SMTP) mail server:** field enter the outgoing mail server address.
19. Check the appropriate fields and then tap OK.
 - **Outgoing server requires authentication** is used if a password is required for outgoing mail in addition to incoming mail. (Please contact your System Administrator for detailed server requirements.)
Use the same user name and password for sending e-mail to use the same user name and password for outgoing mail as well as for incoming mail (can only be selected if the **Outgoing server requires authentication** checkbox is checked).
20. Tap the **Advanced Server Settings** link.
 - These allows configuration of server-specific messaging settings such as SSL requirements for both incoming and outgoing email, as well as network firewall profiles.
 - Select the desired options.
 - Tap **Done** once completed making updates to these settings.
21. Tap **Next**.
22. In the **Automatic Send/Receive:** drop-down list select the time interval for the ES400 to send and check for new email.
23. Tap the **Review all download settings** link for additional download settings and options.

24. Tap **Finish**.

Editing an Email Account

To edit general email settings:

1. Press .
2. Highlight an account and tap **Menu > Options**.
3. Tap the desired email account from the on screen list.
4. Tap **Edit Account Setup**.
5. Confirm the **email address** and make any changes if necessary. Tap **Next**.
6. Confirm the **Your name** and **Account display name** information and make any changes if necessary. Tap **Next**.
7. Confirm the **Incoming mail server** and **Account type** information and make any changes if necessary. Tap **Next**.
8. Confirm the **User name** and **Password** information and make any changes if necessary (including checking or unchecking the **Save password** checkbox). Tap **Next**.
9. Confirm the **Outgoing (SMTP) mail server** information and make any changes if necessary.
10. Tap the **Advanced Server Settings** link and select any setting on this page to check or uncheck the option.
 - **Require SSL for Incoming e-mail** check box to enable SSL encryption of incoming email (if supported by the mail server).
 - **Require SSL for Outgoing e-mail** checkbox to enable SSL encryption of outgoing email (if supported by the mail server).
 - **Network connection** drop-down list to select a firewall connection setting. Select either **The Internet** (open: no firewall), **Work** (behind a firewall) or a data connection.
11. Tap **Done** and then tap **Next**.
12. In the **Automatic Send/Receive** drop-down list, select the time interval the ES400 sends and checks for new email.
13. In the **Download messages** drop-down list, select the age range of messages to download from the server to the ES400. (The longer the time period, the more messages are downloaded.)
14. Tap the **Advanced Settings** link and select any setting on this page to check or uncheck the option.
 - Select the **Send/receive when I click Send** checkbox to automatically check for and download new messages whenever the user sends a message.
 - Select the **Use automatic send/receive schedule when roaming** checkbox to continue to check the email at predetermined intervals even if in a roaming area.
 - In the **When deleting messages** drop-down list select whether to automatically delete or retain messages on the email server when deleting messages from the ES400.
15. Tap **Done**.
16. Tap **Next**.

17. Tap an on screen field and change any settings you wish. Tap an option to select it.
 - In the **Message format** drop-down list, select to view your email messages as either **HTML** or **plain text** documents.
 - In the **Message download limit** drop-down list, select the size limit of files attached to email messages.
18. Tap **Finish**.

Setting Email Signatures

Signatures are the string of text automatically added to the end of an outgoing emails or messages.

1. Press  .
2. Tap **Menu > Options**.
3. Highlight an account and tap **Signatures**.
4. In the **Select an account** drop-down list, select a pre-existing account.
5. Tap the **Use signature with this account** checkbox to enable a signature to be automatically added to new outgoing messages.
6. Tap the **Use when replying and forwarding** checkbox to enable a signature to be automatically added to any messaging being replied to or being forwarded from the account.
7. Tap in the text field and enter a signature message.
8. Tap **OK** to save the new signature.

Using Microsoft ActiveSync With a Corporate Outlook Account

Microsoft ActiveSync can be used to sync corporate email with the ES400. If your company uses Microsoft Exchange Server 2003 and 2007 as the corporate email system, you can use Exchange ActiveSync to wirelessly synchronize your email and organizer information directly with your company's Exchange server.

The setup process is done wirelessly by using the ActiveSync™ application already located on the ES400. To synchronize wirelessly using the Microsoft Exchange Server, you must first:

- Activate data services with carrier.
 - Use an existing Exchange (Outlook™) email account.
 - Collect the following information:
 - Exchange Server address and domain name.
 - User name and password.
1. Tap **Start > ActiveSync**.
 2. Tap **Menu > Add Server Source**.
 3. In the **E-mail address** field enter the work email address.
 4. If the network requires SSL encryption, select the **Attempt to detect Exchange Server Settings automatically** checkbox and tap **Next**.
If the checkbox is deselected, enter the Exchange Mail Server address later in the setup process.

5. In the **User name** field, enter the username.
6. In the **Password** field, enter the associated password.
7. In the **Domain** field, enter the server domain name.
8. Leave the **Save password** checkbox selected to avoid having to enter the password whenever logging on to the account, and tap **Next**.
The ES400 begins to try detecting the Exchange Server information automatically.
Tap **Skip** to manually enter the information.
9. In the **Server address** field, enter the appropriate information.
 - If the Exchange Server requires SSL encryption, tap the **This server requires an encrypted (SSL) connection** checkbox and then tap **Next**.
10. Tap the boxes for the types of information to synchronize with the Exchange Server.
11. To adjust the settings, tap an entry from the list (such as Calendar or E-mail) and tap the **Settings** button.
 - Calendar sync allows synchronizing calendar events with the Exchange Server up to a determined time frame. Choose from: **All**, **2 Weeks**, **1 Month**, **3 Months**, or **6 Months**.
 - E-mail sync lets you choose your email sync settings:
 - **Download the past**: determines how far back in email history to maintain a sync record between the ES400 and the Exchange Server.
 - **Message Format**: determines what display format to use when viewing an email (**HTML** or **Plain Text**).
 - **Download size limit**: determines the size limits of incoming email messages.
 - **Include file attachments**: choose whether or not to include attachments and set size limits (in KB) for any attachment.
 - **Advanced...** configures security options, manages certificates, and assigns a return email address (found in the **From:** field).
12. Tap **Finish**.

MMS Messaging

If a SIM card from a non-supported carrier is installed, the MMS options must be configured manually. To configure the ES400 for MMS messaging:



1. Obtain all necessary information from the carrier.
2. Press .
3. Tap  > **MMS Options**.
4. Select **Servers** tab.



Figure 11-21 MMS Options Server Tab

5. Enter the data in the fields and tap **Done**.

Voice Commander

Use the **Voice Commander Settings** to configure the **Voice Commander** application. There are five major functions:

- Contacts
- Applications
- Music
- Digit Trainer
- Advanced Settings.

To configure **Voice Commander** setting tap **Start > Settings > Personal > Voice Commander Settings**.

Contacts Settings

The **Contacts** tab lists all the names in the ES400 Contacts and SIM card (if installed). When a new contact is created, Voice Commander automatically updates the recognition database.

A check in a box indicates that the contact can be recognized normally. An unchecked box indicates that the contact is not in the recognition range. A grayed box indicates that the name contains some unrecognizable characters, such as symbols or marks. The user can build a voice tag to enable it.

The default recognition database is limited to 2,000 contacts. The user can check the leading checkboxes of the contacts exceeding 2,000 items to enable additional entries.



Play



Tap  to hear the pronunciation of a contact.

Voice Tag

The user can record a voice tag for selected contacts to enhance usability and accuracy.  indicates that the voice tag is built.

To record a voice tag:

1. Select a contact.
2. Tap .
3. After the beep, say the contacts name or nickname. For example: *The Boss*.
4. After the second beep, repeat it.
5. Voice Commander builds the recorded voice tag.
6. Voice Commander plays back the recorded voice tag to confirm the voice tag has been created successfully, and  appears to the right of the contact name.

✓ **NOTE** Tap  again rebuild the voice tag. Tap  to delete the voice tag.

Application Settings

The **Application** tab lists all the applications installed in the **Start** menu. When a new application installed, **Voice Commander** automatically updates the recognition database.

A check in a box indicates that the application can be recognized normally. An unchecked box indicates that the application is not in the recognition range. A grayed box indicates that the application name contains some unrecognizable characters, such as symbols or marks. The user can build a voice tag to enable it.



Play



Tap  to hear the pronunciation of an application.

Voice Tag

The user can record a voice tag for selected applications to enhance usability and accuracy.  indicates that the voice tag is built.

To record a voice tag:

1. Select an application.
2. Tap .
3. After the beep, say the application name. For example: *File Explorer*.
4. After the second beep, repeat it.
5. **Voice Commander** builds the recorded voice tag.
6. **Voice Commander** plays back the recorded voice tag to confirm the voice tag has been created successfully, and  appears to the right of the contact name.

✓ **NOTE** Tap  again rebuild the voice tag. Tap  to delete the voice tag.

Music Settings

The **Music** tab lists all the music files found on the ES400. When a media file is downloaded, **Voice Commander** automatically updates the recognition database.

A check in a box indicates that the music file can be recognized normally. An unchecked box indicates that the music file is not in the recognition range. A grayed box indicates that the music file name contains some unrecognizable characters, such as symbols or marks. The user can build a voice tag to enable it.



Play



Tap  to hear the pronunciation of an application.

Voice Tag

The user can record a voice tag for selected music file to enhance usability and accuracy.  indicates that the voice tag is built.

To record a voice tag:

1. Select a music file.
2. Tap .
3. After the beep, say the music file name. For example: *Drive*.
4. After the second beep, repeat it.
5. **Voice Commander** builds the recorded voice tag.
6. **Voice Commander** plays back the recorded voice tag to confirm the voice tag has been created successfully, and  appears to the right of the music file name.

✓ **NOTE** Tap  again rebuild the voice tag. Tap  to delete the voice tag.

Digit Trainer Settings

The user can improve the Voice Commander digit dialing success by performing the Digit Trainer sequence:

1. Tap .
2. Start reading first string after hearing a beep. When finished, the system plays back the recorded voice and ask for confirmation.
3. If the utterance is correct and clear, tap **Yes**. The system moves into next digit string for recording.
If the utterance is incorrect, tap **No**. The system stays at the current string for re-recording.
4. Repeat steps 1 through 3 for the remainder of the strings (at any time, tap **Cancel** to stop.)
5. After finishing the recording of 10 digit strings, tap **Done** to confirm the adapted model or tap **Remove All** to delete the adapted model and re-train.

Digit Setting Settings

Use the **Digit Setting** tab to set valid phone number lengths to improve digit recognition accuracy. The user can change the default settings based on the local telecom requirement. The user can also select **No constraint** checkbox to disable this limitation, though with the trade off of increased errors caused by surrounding noises.

✓ **NOTE** The maximum phone number length is 18 digits.

Advanced Settings

Use the **Advanced Settings** tab to set the voice recognition sensitivity. Select:

- Sensitive: makes the recognizer easier to return a recognition result, whenever there is an utterance detected. This setting is used in environment with stationary noises, such as in a car, a bus or a factory.
- Normal: this setting is used in most environments.
- Accurate: when selected, the recognizer becomes very strict in responding to user's voice commands. This is to reduce misunderstanding calls or actions that could be triggered by unrelated voices issued by surrounding people.

Chapter 12 Accessories

Introduction

Table 12-1 lists the accessories available for the ES400.

Table 12-1 ES400 Accessories

Accessory	Part Number	Description
Cradles		
Single Slot USB Cradle	CRD400-1000R	Charges the ES400 battery. Synchronizes the ES400 with a host computer through a USB connection.
Vehicle Holder	VCH400-1000R	Installs in a vehicle and charges the ES400 battery.
Cables		
USB Rapid Charge Cable	25-128458-01R	Charges the ES400 in a vehicle holder.
Commercial Auto Charge Cable	VCA400-01R	Charges the ES400 in a vehicle holder.
Consumer Grade Auto Charge Cable	CAC400-1000R	Charges the ES400 in a vehicle holder.
Miscellaneous		
Power Supply	PWRS-124306-01R	Provides power to the ES400 or Single Slot USB Cradle using the USB Rapid Charge Cable.
1540 mAh Battery	BTRY-ES40EAB00	Replacement battery.
3080 mAh Battery	BTRY-ES40EAB02	Replacement battery.
1540 mAh Battery Kit	KT-125233-01R	Replacement battery cover and stylus.
3080 mAh Battery Kit	KT-125234-01R	Replacement battery cover and stylus.
1540 mAh Battery Kit	BTRY-KT-1X-ES40R	Replacement battery, battery cover and stylus.
3080 mAh Battery Kit	BTRY-KT-2X-ES40R	Replacement battery, battery cover and stylus.

Table 12-1 ES400 Accessories (Continued)

Accessory	Part Number	Description
1X Stylus Kit	KT-125237-03R	Replacement Stylus (3-pack)
2X Stylus Kit	KT-125240-03R	Replacement Stylus (3-pack)
Tether Kit	KT-133855-01R	Replacement tethers (5-pack)
Soft Holster	SG-ES4021210-01R	Soft belt mount holder.
Screen Protector Kit	KT-125249-03R	Package of three screen protectors.
Host Adapter	25-133854-01R	Provides host connections.

USB Rapid Charge Cable

Use the USB Rapid Charge cable to connect the ES400 to the power supply for charging or to a host computer for communication.

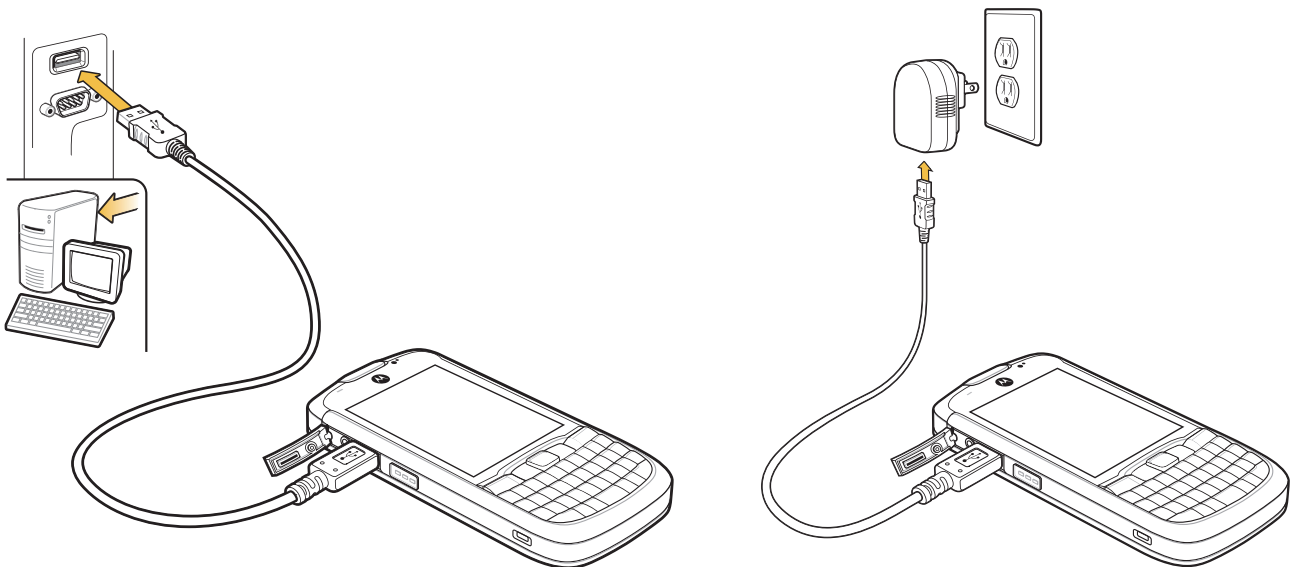
**Figure 12-1** USB Rapid Charge Cable

Single Slot USB Cradle

Use the Single Slot USB Cradle to charge the ES400 and to synchronize information between the ES400 and a host computer.

✓ **NOTE** The Host Adapter can only be connected to the ES400 and not the Single Slot USB cradle.

Charging the ES400 Battery

To charge the ES400 battery:

1. Connect the microUSB connector of the USB Rapid Charge Cable to the USB port on the back of the cradle.
2. Connect the USB-A connector of the USB Rapid Charge Cable to the USB port on the power supply.
3. Plug the power supply into an AC outlet.

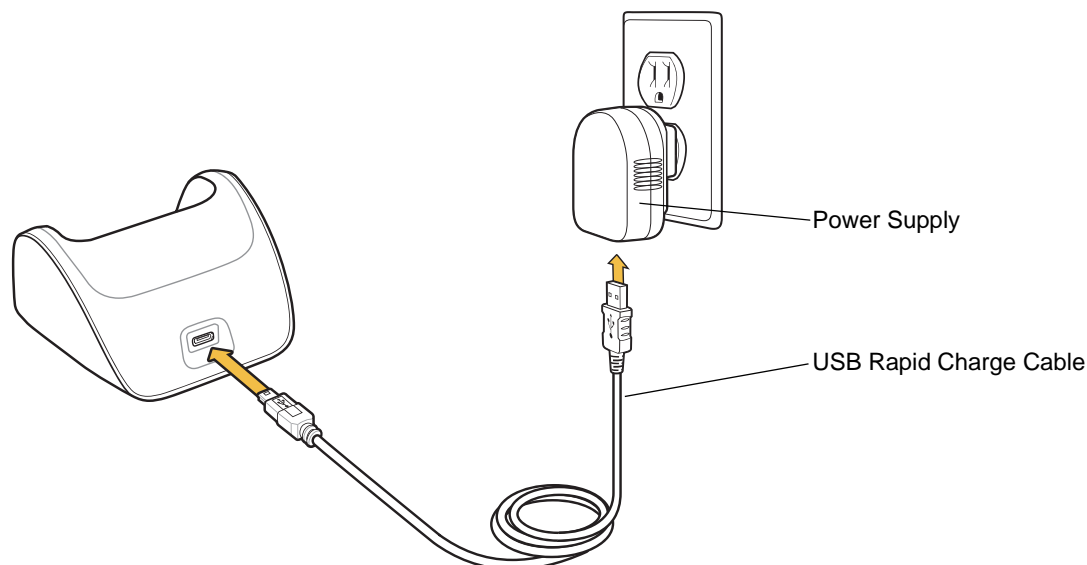

Figure 12-2 Single Slot USB Cradle Setup

4. Place the ES400 into the cradle.

The ES400's LED indicates the status of the battery charging in the ES400. See [Table 2-4 on page 2-20](#) for charging status indications. The 1540 mAh battery fully charges in less than three hours and the 3080 mAh battery fully charges in less than six hours.

Communication with Host Computer

To communicate with a host computer:

1. Ensure ActiveSync is installed and configured on the host computer. See [ActiveSync on page 12-11](#) for more information.
2. Connect the microUSB connector of the USB Rapid Charge Cable to the USB port on the back of the cradle.
3. Connect the USB-A connector of the USB Rapid Charge Cable to the USB port on the host computer.

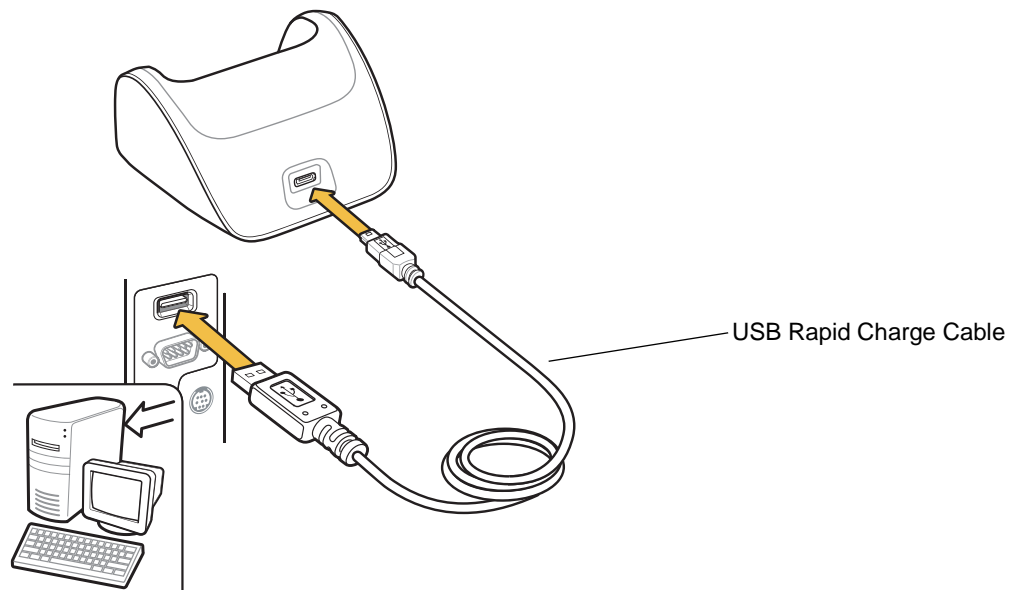

Figure 12-3 *Communication Setup*

4. Place the ES400 into the cradle.
5. The **USB Connect** dialog box appears.
6. Tap **ActiveSync RNDIS** or **ActiveSync Serial**.
7. Tap **Connect**.

Vehicle Holder



WARNING! Some countries prohibit the mounting of any electronic device in any location on the vehicle dashboard. Be sure to check with local laws acceptable mounting areas before installing the auto mounting kit.

Install the vehicle mount on the surface of the vehicle that is reasonably flat and free of dirt and oil. Clean the mounting surface with a glass cleaner and a clean cotton cloth. Install the vehicle mount on the windshield or other flat car surface using the supplied mounting disc.

Windshield Installation

1. Fix the suction cup mount to the selected area with the suction lever facing up.

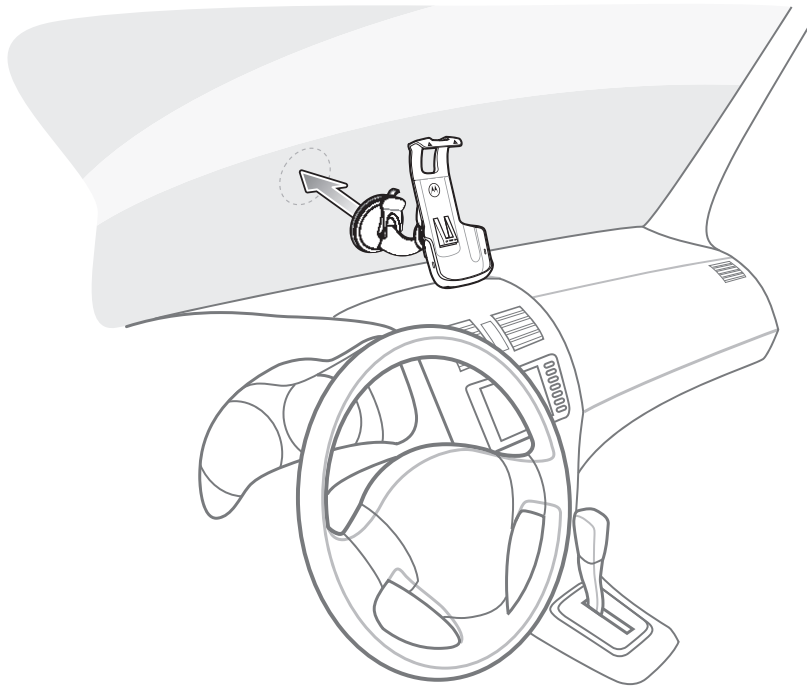

Figure 12-4 *Install on Windshield*

2. Flip the lever down to create a vacuum between the suction cup and the mounting surface.

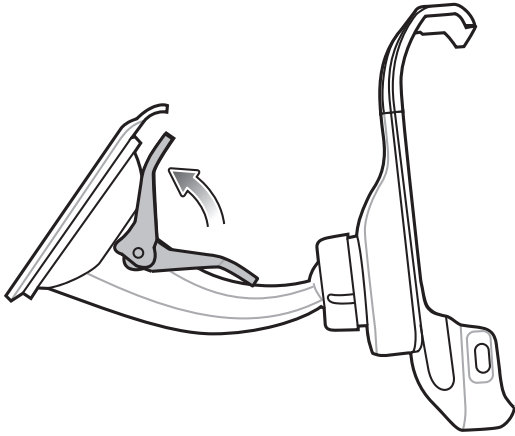

Figure 12-5 *Move lever Toward Windshield*

3. Make sure that the suction bond is strong enough before proceeding to the next step.

Install the ES400

To install the ES4000 into the Vehicle Holder:

1. Place the ES400 bottom first into the holder.
2. Push the ES400 back until it snaps into place.

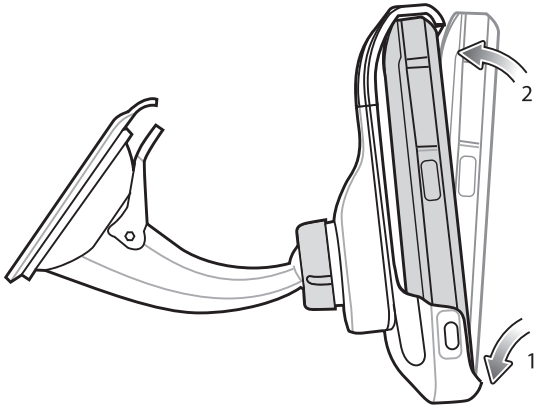

Figure 12-6 *Insert ES400 into Vehicle Holder*

3. Position the ES400 for best viewing.
4. Tighten the nuts to lock the holder in place.

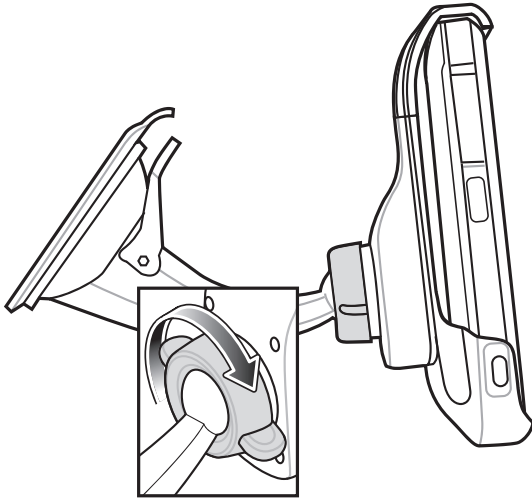

Figure 12-7 *Tighten Nut*

Connect Power

To connect power to the Vehicle Holder:

1. If required, connect the micro-USB connector of the auto charger to the input power connector in the vehicle holder.

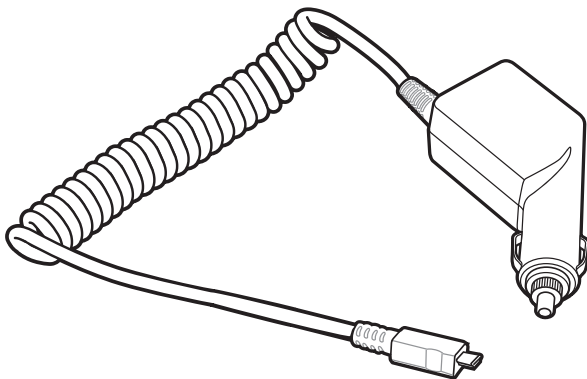

Figure 12-8 *Commercial Grade Auto-Charger*

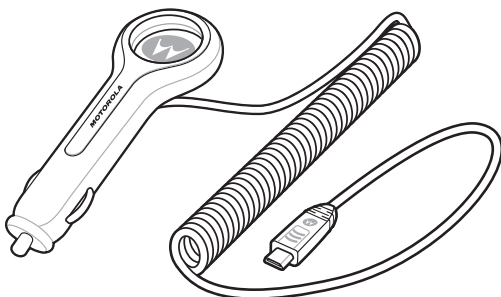

Figure 12-9 *Consumer Grade Auto Charger*

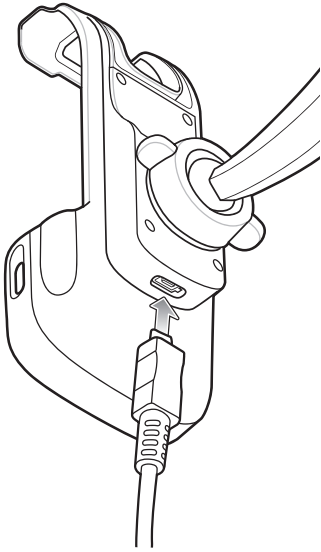

Figure 12-10 *Connect Auto-Charge Cable to Vehicle Holder*

2. Connect the other end to the cigarette lighter socket.
The LED indicator flashes green indicating the ES400 is charging.

Remove the ES400

To remove the ES400 from the Vehicle Holder lift the ES400 up and then remove from the bottom of the holder.

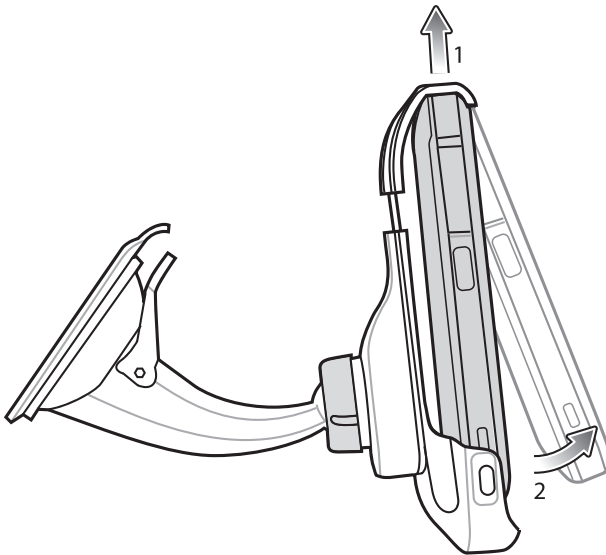

Figure 12-11 *Remove ES400 from Vehicle Holder*

Host Adapter

Use the host adapter to connect accessory devices, such as printer or USB flash drives) to the ES400.

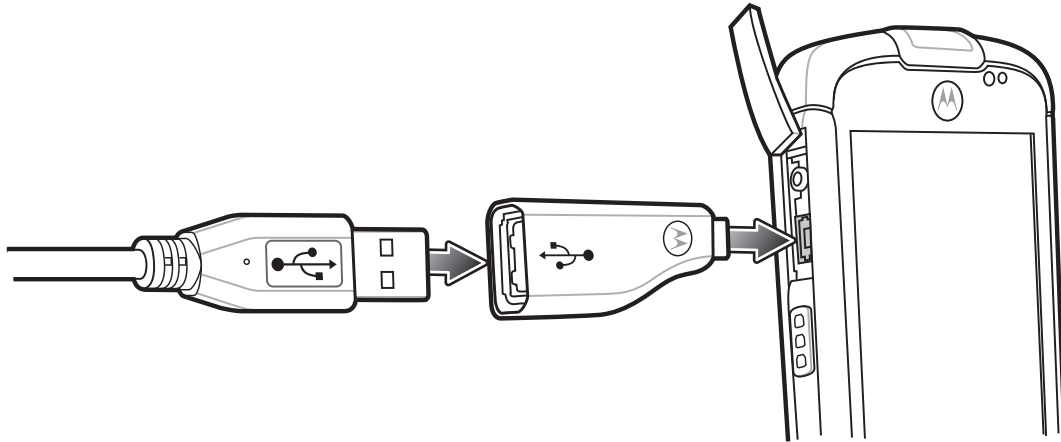

Figure 12-12 Host Adapter Connection

✓ **NOTE** The Host Adapter can only be connected to the ES400 and not the Single Slot USB cradle.



CAUTION Do not connect a USB device that draws more than 100 mA. If a device is connected that draws more than 100 mA, the ES400 displays a Warning dialog box. Remove the device from the Host Adapter.

1. Lift the rubber door.
2. Connect the Host Adapter to the microUSB port on the side of the ES400.
3. Connect the a device's connector to the Host Adapter.

✓ **NOTE** When connecting a USB Flash drive to the Host Adapter, the USB Flash Drive appears in File Explore as **Hard Drive** under **My Device** folder.

Holster

The holster clips onto a belt and stores the ES400 when not in use or when using a Bluetooth headset.

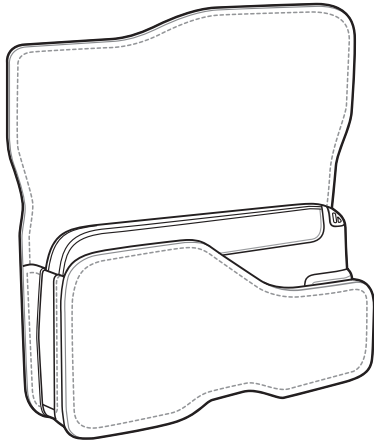

Figure 12-13 *Soft Holster*

Place the ES400 with the display toward the body into the holster. The ES400 automatically goes into suspend mode (depending upon the holster application setting).

Use the **Holster** window to control the behavior of the ES400 when it is placed in a holster.

1. Tap **Start > Settings > Personal > Holster**.
2. Tap **Profile set to** to select a profile for when the ES400 is placed in the holster. See [Power & Radio on page 2-15](#) for a description of each profile.
3. Tap **Display wake up on removal** to set the ES4000 to wake when it is removed from the holster.
4. Tap **OK** when done.

ActiveSync

To communicate with various host devices, install Microsoft ActiveSync (version 4.5 or higher) on the host computer. Use ActiveSync to synchronize information on the ES400 with information on the host computer. Changes made on the ES400 or host computer appear in both places after synchronization.

- ✓ **NOTE** When the ES400 is connected to a host computer and an ActiveSync connection is made, the WLAN radio is disabled. This is a Microsoft security feature to prevent connection to two networks at the same time.

ActiveSync software:

- Allows working with mobile computer-compatible host applications on the host computer. ActiveSync replicates data from the mobile computer so the host application can view, enter, and modify data on the mobile computer.
- Synchronizes files between the mobile computer and host computer, converting the files to the correct format.
- Backs up the data stored on the mobile computer. Synchronization is a one-step procedure that ensures the data is always safe and up-to-date.
- Copies (rather than synchronizes) files between the mobile computer and host computer.
- Controls when synchronization occurs by selecting a synchronization mode, e.g., set to synchronize continually while the mobile computer is connected to the host computer, or set to only synchronize on command.
- Selects the types of information to synchronize and control how much data is synchronized.

Installing ActiveSync

To install ActiveSync on the host computer, download version 4.5 or higher from the Microsoft web site at <http://www.microsoft.com>. Refer to the installation procedures included with the ActiveSync software.

ES400 Setup

- ✓ **NOTE** Microsoft recommends installing ActiveSync on the host computer before connecting the ES400.

The ES400 can be set up to communicate with a USB connection. The ES400 communication settings must be set to match the communication settings used with ActiveSync.

1. On the ES400 tap **My Apps > ActiveSync**.
2. Tap **Menu > Connections**.
3. Select the connection type from the drop-down list.
4. Tap **OK** to exit the **Connections** window and tap **OK** to exit the **ActiveSync** window.
5. Proceed with installing ActiveSync on the host computer and setting up a partnership.

Setting Up an ActiveSync Connection on the Host Computer

To start ActiveSync:

1. Select **Start > Programs > Microsoft ActiveSync** on the host computer.

✓ **NOTE** Assign each ES400 a unique device name. Do not try to synchronize more than one ES400 to the same name.

2. In the **ActiveSync** window, select **File > Connection Settings**. The **Connection Settings** window appears.
3. Select **Allow USB connections** check box.
4. Select the **Show status icon in Taskbar** check box.
5. Select **OK** to save any changes made.

Synchronization with the ES400

✓ **NOTE** When the ES400 is connected to a host computer and an ActiveSync connection is made, the WLAN radio (if applicable) is disabled. This is a Microsoft security feature to prevent connection to two networks at the same time.

To synchronize with the ES400:

1. If the **Get Connected** window does not appear on the host computer, select **Start > ActiveSync** and then click **Next**.
2. Select the check box to synchronize with a server running Microsoft Exchange if applicable and then click **Next**.
3. Select the appropriate settings and click **Next** and then click **Finish**.

During the first synchronization, information stored on the ES400 is copied to the host computer. When the copy is complete and all data is synchronized, the ES400 can be disconnect from the host computer.

✓ **NOTE** The first ActiveSync operation must be performed with a local, direct connection. Windows Mobile retains partnerships information after a cold boot.

For more information about using ActiveSync, start ActiveSync on the host computer, then see ActiveSync Help.

Chapter 13 Maintenance & Troubleshooting

Introduction

This chapter includes instructions on cleaning and storing the ES400, and provides troubleshooting solutions for potential problems during ES400 operation.

Maintaining the ES400

For trouble-free service, observe the following tips when using the ES400:

- Do not scratch the screen of the ES400. When working with the ES400, use the supplied stylus or plastic-tipped pens intended for use with a touch-sensitive screen. Never use an actual pen or pencil or other sharp object on the surface of the ES400 screen.
- The touch-sensitive screen of the ES400 is polycarbonate. Do not drop the ES400 or subject it to strong impact.
- Protect the ES400 from temperature extremes. Do not leave it on the dashboard of a car on a hot day, and keep it away from heat sources.
- Do not store the ES400 in any location that is dusty, damp or wet.
- Use a soft lens cloth to clean the ES400. If the surface of the ES400 screen becomes soiled, clean it with a soft cloth moistened with a diluted window-cleaning solution.
- Periodically replace the rechargeable battery to ensure maximum battery life and product performance. Battery life depends on individual usage patterns.

Battery Safety Guidelines

- The area in which the units are charged should be clear of debris and combustible materials or chemicals. Particular care should be taken where the device is charged in a non commercial environment.
- Follow battery usage, storage, and charging guidelines found in the user's guide.
- Improper battery use may result in a fire, explosion, or other hazard.

- To charge the mobile device battery, the battery and charger temperatures must be between +32 °F and +104 °F (0 °C and +40 °C)
- Do not use incompatible batteries and chargers. Use of an incompatible battery or charger may present a risk of fire, explosion, leakage, or other hazard. If you have any questions about the compatibility of a battery or a charger, contact Motorola Enterprise Mobility support.
- For devices that utilize a USB port as a charging source, the device shall only be connected to products that bear the USB-IF logo or have completed the USB-IF compliance program.
- To enable authentication of an approved battery, as required by IEEE1725 clause 10.2.1, all batteries will carry a Motorola hologram. Do not fit any battery without checking it has the Motorola authentication hologram.
- Do not disassemble or open, crush, bend or deform, puncture, or shred.
- Severe impact from dropping any battery-operated device on a hard surface could cause the battery to overheat.
- Do not short circuit a battery or allow metallic or conductive objects to contact the battery terminals.
- Do not modify or remanufacture, attempt to insert foreign objects into the battery, immerse or expose to water or other liquids, or expose to fire, explosion, or other hazard.
- Do not leave or store the equipment in or near areas that might get very hot, such as in a parked vehicle or near a radiator or other heat source. Do not place battery into a microwave oven or dryer.
- Battery usage by children should be supervised.
- Please follow local regulations to properly dispose of used re-chargeable batteries.
- Do not dispose of batteries in fire.
- In the event of a battery leak, do not allow the liquid to come in contact with the skin or eyes. If contact has been made, wash the affected area with large amounts of water and seek medical advice.
- If you suspect damage to your equipment or battery, contact Motorola Enterprise Mobility support to arrange for inspection.

Cleaning



CAUTION Always wear eye protection.

Read warning label on compressed air and alcohol product before using.

If you have to use any other solution for medical reasons please contact Motorola for more information.



WARNING! Avoid exposing this product to contact with hot oil or other flammable liquids. If such exposure occurs, unplug the device and clean the product immediately in accordance with these guidelines.

Materials Required

- Alcohol wipes
- Lens tissue
- Cotton tipped applicators

- Isopropyl alcohol
- Can of compressed air with a tube.

Cleaning the ES400

Housing

Using the alcohol wipes, wipe the housing including keys and in-between keys.

Display

The display can be wiped down with the alcohol wipes, but care should be taken not to allow any pooling of liquid around the edges of the display. Immediately dry the display with a soft, non-abrasive cloth to prevent streaking.

Camera Window

Wipe the camera window periodically with a lens tissue or other material suitable for cleaning optical material such as eyeglasses.

Interface Connector

1. Remove the battery from ES400.
2. Dip the cotton portion of the cotton tipped applicator in isopropyl alcohol.
3. Rub the cotton portion of the cotton tipped applicator back-and-forth across the interface connector on the back of the ES400. Do not leave any cotton residue on the connector.
4. Repeat at least three times.
5. Use the cotton tipped applicator dipped in alcohol to remove any grease and dirt near the connector area.
6. Use a dry cotton tipped applicator and repeat steps 3 through 5.
7. Spray compressed air on the connector area by pointing the tube/nozzle about ½ inch away from the surface. CAUTION: Do not point nozzle at yourself and others, ensure the nozzle or tube is away from your face.
8. Inspect the area for any grease or dirt, repeat if required.
9. Replace the battery.

Battery Contacts

1. Remove the battery from ES400.
2. Dip the cotton portion of the cotton tipped applicator in isopropyl alcohol.
3. Rub the cotton portion of the cotton tipped applicator back-and-forth across the battery contacts on the bottom of the battery. Do not leave any cotton residue on the contacts.
4. Repeat at least three times.
5. Use the cotton tipped applicator dipped in alcohol to remove any grease and dirt near the contact area.
6. Use a dry cotton tipped applicator and repeat steps 3 through 5.
7. Spray compressed air on the contact area by pointing the tube/nozzle about ½ inch away from the surface. CAUTION: Do not point nozzle at yourself and others, ensure the nozzle or tube is away from your face.

8. Inspect the area for any grease or dirt, repeat if required.
9. Replace the battery in the ES400.

Cleaning Cradle Connectors

To clean the connectors on a cradle:

1. Disconnect the USB Rapid Charging cable from the cradle.
2. Dip the cotton portion of the cotton tipped applicator in isopropyl alcohol.
3. Rub the cotton portion of the cotton tipped applicator along the pins of the connector(s). Slowly move the applicator back-and-forth from one side of the connector to the other. Do not let any cotton residue on the connector.
4. All sides of the connector should also be rubbed with the cotton tipped applicator.
5. Spray compressed air in the connector area by pointing the tube/nozzle about ½ inch away from the surface. CAUTION: do not point nozzle at yourself and others, ensure the nozzle or tube is pointed away from your face.
6. Ensure that there is no lint left by the cotton tipped applicator, remove lint if found.
7. If grease and other dirt can be found on other areas of the cradle, use lint free cloth and alcohol to remove.
8. Allow at least 10 to 30 minutes (depending on ambient temperature and humidity) for the alcohol to air dry before applying power to cradle.

If the temperature is low and humidity is high, longer drying time is required. Warm temperature and dry humidity requires less drying time.

Cleaning Frequency

The cleaning frequency is up to the customer's discretion due to the varied environments in which the mobile devices are used. They may be cleaned as frequently as required. However when used in dirty environments, it may be advisable to periodically clean the scanner exit window to ensure optimum scanning performance.

Troubleshooting

ES400

Table 13-1 *Troubleshooting the ES400*

Problem	Cause	Solution
ES400 does not turn on.	Battery not charged.	Charge or replace the battery in the ES400.
	Battery not installed properly.	Install the battery properly. See Installing the Battery on page 1-5 .
	System crash.	Perform a reboot. See Resetting the ES400 on page 2-21 .
Battery did not charge.	Battery failed.	Replace battery. If the ES400 still does not operate, perform a reboot. See Resetting the ES400 on page 2-21 .
	No power to cradle or cable.	Ensure that power is applied to the cradle or cable. The Battery Status LED flashes green to indicate that the ES400 is charging.
	ES400 removed from cradle while battery was charging.	Place the ES400 into the cradle. The 1540 mAh battery fully charges in less than three hours and the 3080 mAh battery charges in less than six hours.
	Extreme battery temperature.	Battery does not charge if ambient temperature is below 0°C (32°F) or above 40°C (104°F).
	ES400 not functioning.	Perform a reboot. See Resetting the ES400 on page 2-21 .
Cannot see characters on display.	ES400 not powered on.	Press the Power button.
During data communication, no data transmitted, or transmitted data was incomplete.	ES400 removed from cradle or disconnected from host computer during communication.	Replace the ES400 into the cradle, or reattach the USB Rapid Charging cable and re-transmit.
	Communication software was incorrectly installed or configured.	Perform setup. See to ActiveSync on page 12-11 for details.
No sound.	Volume setting is low or turned off.	Adjust the volume. See Adjusting Volume on page 2-19 .
ES400 shuts off.	ES400 is inactive.	The ES400 turns off after a period of inactivity. See Power & Radio on page 2-15 for more information.
	Battery is depleted.	Recharge or replace the battery.

Table 13-1 Troubleshooting the ES400 (Continued)

Problem	Cause	Solution
Tapping the window buttons or icons does not activate the corresponding feature.	Screen is not calibrated correctly.	Re-calibrate the screen. Tap Start > Settings > System > Screen > Align Screen button.
	The ES400 is not responding.	Reboot the ES400. See Resetting the ES400 on page 2-21 .
A message appears stating that the ES400 memory is full.	Too many files stored on the ES400.	Delete unused memos and records. If necessary, save these records on the host computer (or use an microSD card for additional memory).
	Too many applications installed on the ES400.	Remove user-installed applications on the ES400 to recover memory. Tap Start > Settings > System > Remove Programs . Select the unused program and tap Remove .
Camera application does not launch.	DataWedge application running.	Stop DataWedge application. Tap Start > Settings > System > DataWedge . Tap Running to stop DataWedge and then tap OK .
The ES400 does not decode while reading a bar code.	Scanning application is not loaded.	Load a scanning application on the ES400. See your system administrator.
	Unreadable bar code.	Ensure the symbol is not defaced.
	Distance between exit window and bar code is incorrect.	Place the ES400 within proper scanning range.
	ES400 is not programmed for the bar code.	Program the ES400 to accept the type of bar code being scanned. Refer to the EMDK.
	ES400 is not programmed to generate a beep.	If the ES400 does not beep on a good decode, set the application to generate a beep on good decode.
Phone service is not available with SIM card installed.	SIM card might not be installed properly.	Re-install SIM card and ensure that it is seated properly. See Installing the SIM Card (GSM Only) on page 1-4 .

Bluetooth Connection

Table 13-2 *Troubleshooting Bluetooth Connection*

Problem	Cause	Solution
ES400 cannot find any Bluetooth devices nearby.	Too far from other Bluetooth devices.	Move closer to the other Bluetooth device(s), within a range of 10 meters (32.8 feet).
	The Bluetooth device(s) nearby are not turned on.	Turn on the Bluetooth device(s).
	The Bluetooth device(s) are not in discoverable mode.	Set the Bluetooth device(s) to discoverable mode. If needed, refer to the device's user documentation for help.
When trying to connect a Bluetooth phone and ES400, the phone thinks a previously paired ES400 is used.	The phone remembers the name and address of the ES400 it last paired with via the Bluetooth radio.	Manually delete the pairing device and name from the phone. Refer to the phone's user documentation for instructions.

Single Slot USB Cradle

Table 13-3 *Troubleshooting the Single Slot USB Cradle*

Symptom	Possible Cause	Action
ES400 battery is not charging.	ES400 was removed from cradle or cradle was unplugged from power too soon.	Ensure cradle is receiving power. Ensure ES400 is seated correctly. The 1540 mAh battery fully charges in less than three hours and the 3080 mAh battery fully charges in less than six hours.
	Battery is faulty.	Verify that other batteries charge properly. If so, replace the faulty battery.
	No power to cradle.	Ensure that power is applied to the cradle. The ES400 LED flashes green to indicate that the ES400 is charging.
	The ES400 is not fully seated in the cradle.	Remove and re-seat the ES400 onto the cradle properly.
	Extreme battery temperature.	Battery does not charge if ambient temperature is below 0°C (32°F) or above 40°C (104°F).
	Single Slot USB Cradle is not functioning properly.	Replace the Single Slot USB Cradle.

Table 13-3 *Troubleshooting the Single Slot USB Cradle (Continued)*

Symptom	Possible Cause	Action
During data communication, no data transmits, or transmitted data was incomplete.	ES400 removed from cradle during communications.	Replace ES400 in cradle and retransmit.
	Communication software is not installed or configured properly.	Perform setup as described in ActiveSync on page 12-11 .
	Incorrect USB cable is used.	Use the USB Rapid Charge cable provided with the ES400.

Vehicle Holder

Table 13-4 *Troubleshooting the Vehicle Holder*

Symptom	Possible Cause	Action
ES400 LED is not blinking green or solid green.	Cradle is not receiving power.	Ensure the power input cable is securely connected to the cradle's power port.
ES400 battery is not recharging.	ES400 was removed from the cradle too soon.	Replace the ES400 in the cradle. The 1540 mAh battery fully charges in less than three hours and the 3080 mAh battery charges in less than six hours.
	Battery is faulty.	Replace the battery.
	No power to charger.	Ensure that power is applied to the charger. The ES400 LED flashes green to indicate that the battery is charging.
	ES400 is not placed correctly in the cradle.	Remove the ES400 from the cradle, and re-insert correctly. If the battery still does not charge, contact customer support. The ES400 LED blinks green when the ES400 is correctly inserted and charging.
	Ambient temperature of the cradle is too warm.	Move to an area where the ambient temperature is between 0°C and 40°C (.32°F and 104°F)
	Vehicle Holder is not functioning properly.	Replace the Vehicle Holder.

Appendix A Technical Specifications

ES400 Technical Specifications

The following tables summarize the Enterprise Smart Phone's intended operating environment and technical hardware specifications.

ES400

Table A-1 ES400 Technical Specifications

Item	Description
Physical Characteristics	
Dimensions	With 1540 mAh battery: Height: 129 mm (5.08 in.) Width: 60.4 mm (2.38 in.) Depth: 16.5 mm (0.67 in.) With 3080 mAh battery: Height: 129 mm (5.08 in.) Width: 60.4 mm (2.38 in.) Depth: 21.5 mm (0.85 in.)
Weight	With 1540 mAh battery: 156 g (5.5 oz.) With 3080 mAh battery: 188.5 g (6.5 oz.)
Display	PenTile® 3 in. diagonal color display, touch, VGA 640 x 480 portrait, Super Bright 750+ NITS (luminous)
Touch Panel	Polycarbonate analog resistive touch with haptic 'touch vibration response'
Backlight	LED backlight
Battery	Rechargeable Lithium Ion 3.7V, 1540 mAh or 3080 mAh Smart battery

Table A-1 ES400 Technical Specifications (Continued)

Item	Description
Expansion Slot	microSD card slot. Supports up to 32 GB cards.
Network Connections	High-speed USB client and host
Notification	Programmable LED, audio notifications and vibrator alerts.
Keypad Options	Alphanumeric; QWERTY, QWERTZ and AZERTY
Audio	VoWWAN; VoWLAN; PTT and TEAM Express ready; rugged audio connector; high-quality speakerphone; support for wired and wireless (Bluetooth) headsets; support for PTT headsets, handset and speaker phone modes
Performance Characteristics	
CPU	600 MHz, ARM 11 processor, MSM 7627
Operating System	Microsoft® Windows Mobile™ 6.5.3 Professional
Memory	256 MB RAM/1 GB Flash
Interface	Motorola Enterprise UI; customizable home screen, enhanced dialer and enterprise camera solution
Output Power	USB: 5 VDC @ 100 mA max.
User Environment	
Operating Temperature	-0°C to 40°C (-32°F to 104°F)
Storage Temperature	-40°C to 70°C (-40°F to 158°F)
Charging Temperature	0° C to 40° C (32°F to 104°F)
Humidity	5 - 95% non-condensing
Drop Specification	Military Standard (MIL-STD) 810G 4 ft./1.22 m drop specification; 3 ft./0.91 m drop to vinyl covered concrete across the operating temperature range (36 drops at 32° F/0° C, room temperature and 104° F/40° C)
Tumble	150 1.65 ft./0.5 m tumbles (equivalent to 300 consecutive drops) at room temperature; meets and exceeds applicable IEC tumble specifications
Electrostatic Discharge (ESD)	+/-15kVdc air discharge, +/-8kVdc direct discharge, +/-8kVdc indirect discharge
Sealing	Meets MIL-STD 810G rain standards; meets and exceeds IP42 sealing
Vibration	MIL-STD 810G Method 514.5, figure 514.5C-1; one hour per axis
Thermal Shock	-20° C to 70° C (-20° F to 158° F) rapid transition
Altitude	-1,200 ft. to 15,000 ft. operational 15,000 ft. shipping
Keyboard/Side Buttons	1 million presses

Table A-1 ES400 Technical Specifications (Continued)

Item	Description
Wireless WAN Data and Voice Communications	
Radio	Dual 3.5G: GSM HSDPA/HSUPA and CDMAEVDO Rev A broadband for voice and data.
Frequency Band	UMTS/HSDPA and HSUPA: 850, 1900 and 2100 MHz GSM/EDGE: 850, 900, 1800 and 1900 MHz CDMA/EVDO Rev A: 850 and 1900 MHz
Antenna	Internal antennas: primary and diversity
Integrated GPS	
GPS	Integrated standalone or Assisted-GPS (A-GPS)
Wireless LAN Data and Voice Communications	
Radio	Tri-mode IEEE® 802.11a/b/g
Data Rates Supported	1, 2, 5.5, 6, 9, 11, 12, 18, 24, 36, 48, and 54 Mbps
Operating Channels	Chan 36-165 (5180 – 5825 MHz) Chan 1-13 (2412-2472 MHz) Chan 14 (2484 MHz) Japan only Actual operating channels/frequencies depend on regulatory rules and certification agency
Security	WPA2 (Personal or Enterprise); 802.1x; EAP-TLS; TTLS (CHAP, MS-CHAP, MS-CHAPv2, PAP or MD5); PEAP (TLS, MSCHAPv2, EAP-GTC); LEAP, EAP-FAST (TLS, MS-CHAPv2, EAP-GTC)
Antenna	Internal antenna
Voice Communications	Voice-over-IP ready (with P2P, PBX, PTT clients), Wi-Fi™-certified, IEEE 802.11 a/b/g direct sequence wireless LAN, Wi-Fi Multimedia (WMM), Motorola Voice Quality manager (VQM)
Wireless PAN Data and Voice Communications	
Bluetooth	Class II, v2.0 with Enhanced Data Rate (EDR); integrated antenna
Regulatory	
Electrical Safety	IEC/UL/CSA/EN 60950-1
Environmental	RoHS/WEEE compliant
WLAN and Bluetooth (PAN)	USA: FCC Part 15.247, 15.407 Canada: RSS-210 EU: EN 300 328, EN 301 893 Japan: ARIB STD-T33, T66, T70, T71 Australia: AS/NZS 4268s

Table A-1 ES400 Technical Specifications (Continued)

Item	Description
Wireless Wide Area Network	GSM-HSDPA Global: 3GPP TS 51.010, 3GPP TS 34.121, 3GPP TS 34.123, GCF and PTCRB approved module USA: FCC Part 22, Part 24 Canada: RSS-132, RSS-133 EU: EN 301 511, EN 301 908 Australia: AS/ACIF S 024.1 & 3 CDMA-EvDO Rev A USA: FCC Part 22, Part 24 Canada: RSS-132, RSS-133 HAC compliant
RF Exposure	USA: FCC Part 2, FCC OET Bulletin 65 Supplement C Canada: RSS-102 EU: EN 50360, EN62311 Japan: ARIB STD T56 Australia: Radio communications Standard 2003
EMI/RFI	USA: FCC Part 15, Class B Canada: ICES 003 Class B EU: EN55022 Class B, EN55024, EN 301 489-1, EN 301 489-3, EN 301 489-7, EN 301 489-17, EN 301 489-24, EN 60601-1-2, EN 50121-3-2, EN 50121-4 Australia: AS/NZS CISPR-22
Data Capture Options	
Data Types	1D and 2D bar codes; photographs; video; signatures; documents
Color Camera	
Resolution	3.2 Mega pixel with illumination light and auto focus.
Illumination	User controllable light source for efficient data capture illumination
Lens	Autofocus
Bar Code Scanning	Integrated 1D and 2D decoding; user controllable red line LED aimer
Motorola Interactive Sensor Technology	
Motion-sensor	3-axis accelerometer that enables motion-sensing applications for dynamic screen orientation and power management

Table A-2 Data Capture Options

Item	Description		
Camera Decode Capability	1-D Bar Codes		
	Code 39 WEAN13 UCC/EAN 128 Code 11 Interleaved 2 of 5 UPCE1 Chinese 2 of 5 GS1 DataBar Truncated GS1 DataBar Expanded GS1 DataBar Stacked Omni	UPCA EAN8 ISBT128 Web Code Discrete 2 of 5 Coupon CODE Korean 3 of 5 GS1 DataBar Limited GS1 DataBar Expanded Stacked	UPCE Code 128 Code 93 MSI Codabar Trioptic 39 GS1 DataBar GS1 DataBar Stacked
	2-D Bar Codes		
	PDF-417 Composite AB QR Code Linked Aztec UK 4-state Dutch Postal Image	Micro PDF Composite C Micro QR US Planet Australian 4-state UK Intellimail	Marco Micro PDF Data MAtrix Aztec US Postnet Japanese 4-state Signature

Headset

ES400 accepts 2.5 mm wired headset jacks with the following jack arrangement.

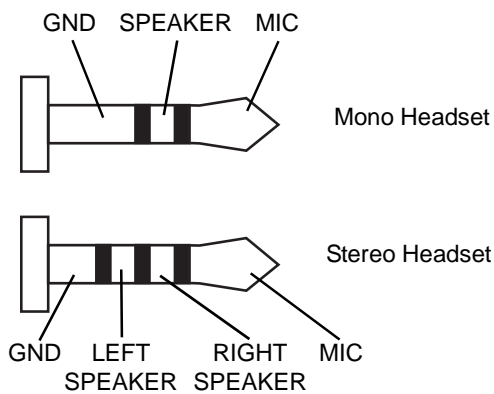

Figure A-1 Headset Jack

ES400 Accessory Specifications

Single Slot USB Cradle

Table A-3 *Single Slot USB Cradle Technical Specifications*

Feature	Description
Dimensions	Height: 56 mm (2.2 in.) Width: 81.6 mm (3.21 in.) Depth: 93 mm (3.66 in.)
Weight	228 g (8.04 oz.)
Input Power	5 VDC, 1.2 A
Interface	USB
Operating Temperature	0°C to 50°C (32°F to 122°F)
Storage Temperature	-40°C to 70°C (-40°F to 158°F)
Charging Temperature	0°C to 40°C (32°F to 104°F)
Humidity	5% to 95% non-condensing
Drop	76.2 cm (30.0 in.) drops to vinyl tiled concrete at room temperature
Electrostatic Discharge (ESD)	+/- 15 kV air +/- 8 kV contact

Appendix B Keypads

Introduction

The ES400 offers three types of alphanumeric keypad configurations:

- QWERTY
- AZERTY
- QWERTZ.

The keypad produces the 26-character alphabet (A-Z, both lowercase and uppercase), numbers (0-9), and assorted characters. The keypad is color-coded to indicate which modifier key to press to produce a particular character or action. The keypad default is lowercase alpha characters. See [Table B-1](#) for key and button descriptions and [Table B-2 on page B-4](#) for the keypad's special characters.



Figure B-1 QWERTY Keypad



Figure B-2 AZERTY Keypad



Figure B-3 QWERTZ Keypad

Table B-1 Keypad Descriptions





Key	Action
fn Key 	Accesses the secondary layer of characters and actions (shown on the keypad in orange). Press the Orange key once to activate this mode temporarily, followed by another key. This illuminates the LED and displays the following icon at the bottom of the screen, until a second key is pressed:  Press the Orange key twice to lock this mode. This illuminates the LED and displays the following icon at the bottom of the screen:  Press the Orange key a third time to unlock.
Talk 	Talk (Green Phone): press to display the phone keypad window or to dial a phone number (from the phone keypad window).

Table B-1 Keypad Descriptions (Continued)













Key	Action
End 	End (Red Phone): press when the phone keypad window displays to stop dialing or end a call.
Scan 	Activates the bar code reader in a scan enabled application.
Optical Nav Pad 	Use to navigate across the screen and press to select items.
Email 	Use to open the Messaging application. When used with the fn key toggles the cursor function.
Start 	Use to instantly display the Start menu from any application without tapping the screen.
OK 	Use this key to close open applications.
Shift 	Changes the state of the alpha characters from lowercase to uppercase. Press the Shift key to activate this mode temporarily, followed by another key. This displays the following icon at the bottom of the screen, until a second key is pressed:  Press the Shift key twice to lock this mode. This displays the following icon at the bottom of the screen:  Press the Shift key a third time to unlock.
Backspace 	Deletes a previous character.
Enter 	Executes a selected item or function.

Table B-1 Keypad Descriptions (Continued)

Key	Action
SPACE 	Produces a space character.
TAB 	Move from one field to another.

Special Character Key

To add special characters using the ES400, press and hold the key until the special characters appear on the screen. Select the desired character. [Table B-2](#) lists the special characters available.

Table B-2 Special Characters

Key	Special Characters	Key	Special Characters
a	á â ã ä å æ ç è é	A	À Á Â Ã Ä Å Æ
c	ç	C	Ç
d	đ	D	Đ
e	é	E	É
g	ğ	G	Ğ
i	í î ï	I	Í Î Ï
l	ł	L	Ł
n	ñ	N	Ñ
o	ó ô õ ö ø	O	Ó Ô Õ Ö Ø
r	ř	R	Ř
s	š	S	Š
t	ť	T	Ť
u	ú û ü	U	Ú Û Ü
w	ŵ	W	Ŵ
y	ý	Y	Ý
z	ź	Z	Ź

Appendix C Windows Mobile Home Screen and Dialer

Introduction

The appendix describes the functionality of the optional Windows Mobile Home screen and Dialer.

Windows Mobile Home Screen

The Windows Mobile Home screen is scrollable and contains a list of application plug-ins and an Information Status bar. The Information Status bar highlights the application plug-in that is under it and provides additional information.



Figure C-1 Windows Mobile Home Screen

To enable the Windows Mobile Home screen:

1. Tap  > **Setting** > **Home**.
2. On the horizontal scroll, select **Items**.
3. In the item list select the **Windows Default** checkbox. Deselect all other checkboxes.
4. Tap **OK**. The Windows Mobile Home screen appears.

Touch and hold the screen with your finger and move the Home screen up and down. As the application names move under the Information Status bar, information relevant to that application appear in the bar.



Figure C-2 *Moving Today Screen*

You can also touch and hold the Information Status bar and move it up and down over an application name. Remove your finger and the Information Status bar and application name center in the screen.



Figure C-3 *Moving Information Status Bar*

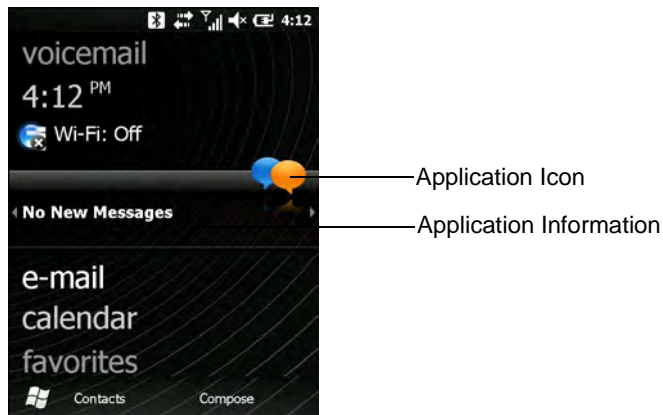

Figure C-4 Information Bar Example

To customize the Home screen, tap **Start > Settings > Today**. On the horizontal scroll, use **Appearance** to customize the background and the **Items** to change the display format.

Classic Today Screen

The user can change the Today screen to the classic layout that is used in Windows Mobile 6.1.

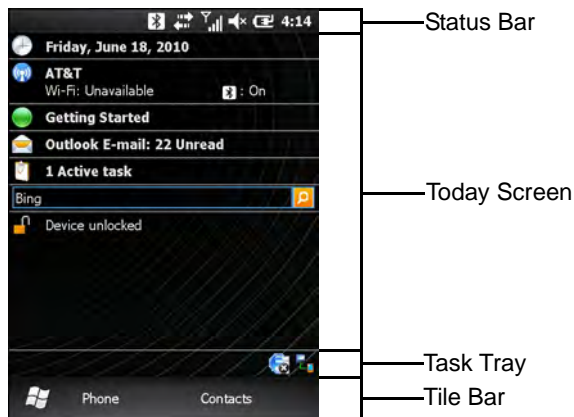

Figure C-5 Classic Today Screen

To change to the classic view tap **Start > Settings > Home > Items**.





Figure C-6 Home Screen Settings

Deselect the **Windows Default** checkbox and select any of the other checkboxes except for **Motorola Home**.



Tap **OK**.

The task bar at the bottom of the screen can contain the task tray icons listed in [Table C-1](#).

Table C-1 Task Tray Icons

Icon	Name	Description
	Fusion	Indicates WLAN signal strength when Fusion is enabled.
	WZC	Indicates WLAN signal strength when WZC is enabled.
	ActiveSync	Active serial connection between the ES400 and the host computer.

Start Screen

To open the **Start** screen, tap  at the bottom left corner of the screen, or press the  on the keypad.

Swipe upward to view more program and folder icons.

You can move often-used program and folder icons anywhere on the Start screen for easy access. Press and hold the icon that you want to move. Drag the icon to a new location and release.

Windows Mobile Dialer

Use the ES400 to make phone calls, set up speed dials, keep track of calls, and send text messages. Your wireless service provider may also provide other services such as voice mail, call forwarding, and caller ID.

Also use the integrated phone to connect to an ISP or work network in order to browse the Web and read e-mail. Connect to the Internet or work network over High-Speed Downlink Packet Access (HSDPA) or Evolution Data-Optimized (EvDO) using Cellular Line.

To enable the Windows Mobile Dialer:

1. Tap **Start > Personal > Dialer Switcher**.
2. Tap **Microsoft Dialer** option.
3. Tap **Save**.



Making a Call

- ✓ **NOTE** You can make emergency calls even when the ES400 is locked or when a SIM card is not installed. See [Emergency Calling on page C-9](#) for more information.

With the ES400, you can make a call from the phone, contacts, speed dial and call history.

Using the Phone Keypad

To make a call using the phone keypad:

1. Press .
2. Enter the phone number on the dialer or keypad. The number appears in the call line.
3. Press .
4. Press  to stop dialing or end the call.

- ✓ **NOTE** If the user taps a wrong number, tap Delete key to erase each subsequent digit of a number. To erase the entire number, tap and hold the Delete key.

Smart Dialing

Smart Dialing makes it easy to dial a phone number. When the user starts entering numbers or characters, Smart Dialing automatically searches and sorts the contact entries on the SIM card, in Contacts, and the phone numbers in Call History (including incoming, outgoing, and missed calls). The user can then select the desired number or contact from the filtered list to dial.

Open the Phone screen, then tap the keys on the Phone keypad that correspond to the phone number or contact to call. The contact panel lists contacts that match the sequence that you entered.

Smart Dialing starts looking for numbers or contacts that match the sequence entered.

To find a phone number:

- Enter the first one or two digits to find a phone number in Call History.
- Enter the first three digits or more to find a phone number from the saved Contacts and SIM card.

To find a contact name:

- Enter the first letter of a contact's first name or last name. Smart Dialing searches for the letter starting from the first character of a contact name as well as from the character that appears after a space, dash, or underscore in a contact name. For example, if you tap number "2" which is associated with [a, b, c] on

the Phone keypad, contact names such as the following will be considered matches: “Smith, Bernard”, “Adams, John”, “Carlson, Eileen”, “Dillon, Albert”, “Childs, Larry”, “Cooper, Robert” and “Parks, Celine”.

- If the matching list is long narrow down the search further by entering another letter. Using the same example above, tap “3” which is associated with (d, e, f), the matching list is narrowed down to the following names: “Smith, Bernard”, “Adams, John”, and “Parks, Celine”.

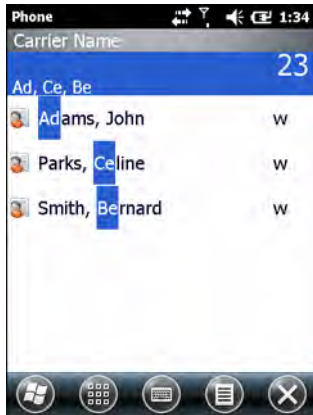



Figure C-7 Finding a Contact

To make a call or send a text message using Smart Dialing:

1. Begin entering the first few numbers or characters.
2. In the Smart Dialing panel, use the up and down arrows on the keypad to navigate to the desired contact or phone number.
3. When the correct contact is selected, press  to make a voice call.
4. To send a text message to the selected contact, tap  > **Send Text Message**.
5. To call a different phone number associated with the selected contact, tap the contact name and select the phone number to call.

Using Contacts

Use Contacts to make a call without looking up or entering the phone number.

To make a call from Contacts:

1. Tap **Contacts**.
2. From the contact list, tap and hold the contact name.

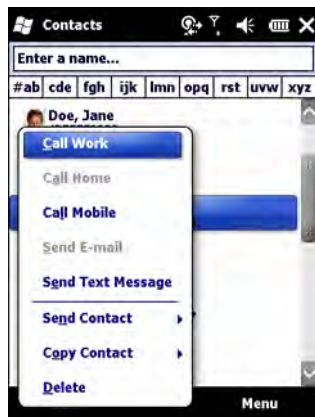



Figure C-8 *Contacts Menu*

3. Tap **Call Work**, **Call Home** or **Call Mobile**.

✓ **NOTE** To make a call from an open contact, tap the number to call. See On-Device Help for more information about Contacts.

Using Call History

To make a call using Call History:

1. Press .
2. From the Phone keypad, tap **Call History**.

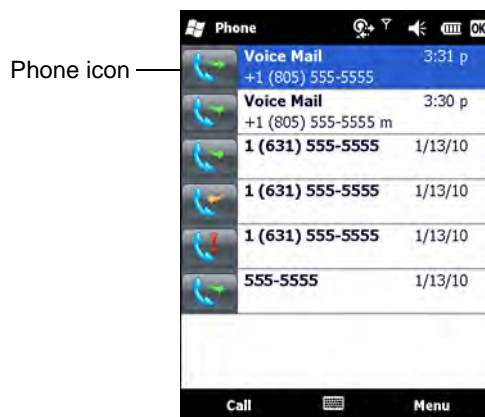



Figure C-9 *Call History Window*

3. Tap the phone icon next to the number to begin dialing and return to the phone keypad.
4. Press  on the ES400 keypad to stop dialing or end the call.

Making a Speed Dial Call

Use Speed Dial to call someone saved in the speed dial directory.

To make a speed dial call:

1. Press .
2. From the keypad, tap and hold the speed dial location number assigned to a contact. (To dial a one-digit speed dial location number, tap and hold the speed dial number. To dial a two-digit speed dial location number, tap the first digit and then tap and hold the second digit.)

or

From the keypad, tap **Speed Dial** and tap the speed dial location number of the desired contact in the list.

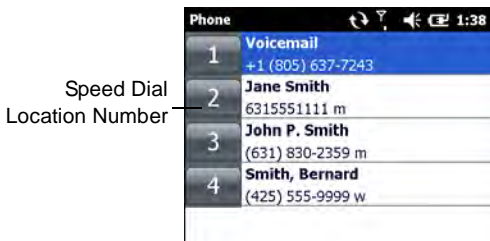



Figure C-10 Speed Dial Contact List

3. To stop dialing or end the call, press .

Answering a Call

A dialog box appears on the ES400 when it receives an incoming call. If the phone is set to ring, a ring tone sounds. Answer or ignore the incoming call.

To answer an incoming call tap **Answer** on the dialog box or press .

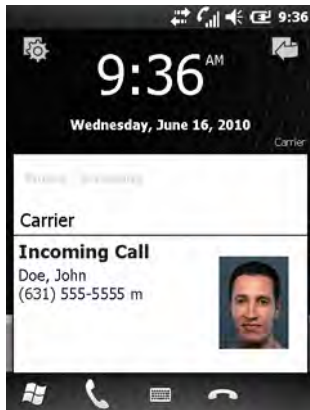







Figure C-11 Incoming Call

To ignore the incoming call tap  or press . This sends the caller to voice mail, depending on the service provider. Otherwise, this presents a busy signal to the calling party.

To end the call press .

Incoming Call Features

- You can use other programs on the ES400 during a call. To switch back to the Phone, press  or tap **Start > Phone**. Press  to end the call.
- If a caller isn't in your contact list, create a contact during the call or from Call History by tapping **Menu > Save to Contacts**.
- To terminate a call when a second call comes in and answer the waiting call, tap **End** on the Phone keypad to disconnect the active call, then tap **Answer** or press the **Send** key to answer the waiting call.
- To hold the current call and answer a waiting call, tap **Answer** or press  to place the current call on hold and answer the incoming call.
- To put a call on hold to call another number or answer an incoming call, tap **Hold**. To move from one call to another, tap **Swap**.

Missed Call Notification

When you do not answer an incoming call, the Home screen displays a **Missed Call** indication.

To display a missed call entry tap the **Missed Call** box on the **Home** screen.

Emergency Calling

Your service provider programs one or more emergency phone numbers, such as 911 or 999, that you can call under any circumstances, even when your phone is locked or the SIM card is not inserted. Your service provider can program additional emergency numbers into your SIM card. However, your SIM card must be inserted in your phone in order to use the numbers stored on it. See your service provider for additional information.

When the alpha primary keypad is locked, press the Orange key twice to set the keypad to numeric mode and then enter the emergency number.



NOTE Emergency numbers vary by country. Your phone's pre-programmed emergency number(s) may not work in all locations, and sometimes an emergency call cannot be placed due to network, environmental, or interference issues.

Muting a Call

During a call, you can mute the microphone so you can hear the person on the line but he or she cannot hear conversation from the microphone. This is useful when there is conversation or background noise on your end.

To mute or unmute a call, tap **Mute** on the dialer to mute the audio. The **Mute** button become **Unmute**.

Using Speed Dial

Create speed dial numbers to dial frequently called numbers with a single tap. Before creating a speed dial entry, ensure the phone number exists in Contacts.

Adding a Speed Dial Entry

To add a speed dial entry from the phone keypad:

1. Ensure the contact and phone number are in the Contacts list.
2. Press .
3. Tap **Speed Dial** button > **Menu** > **New**.
4. Tap the desired contact name and number in the list.

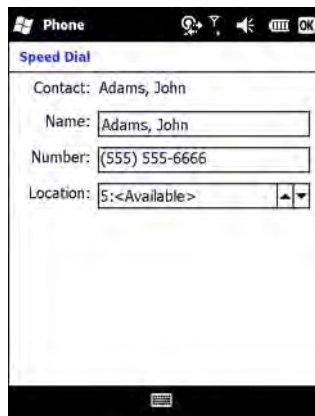

Figure C-12 Speed Dial Contact Location

5. In the **Location** field, tap the up/down arrows to select an available location to assign as the new speed dial entry. The first speed dial location is reserved for voice mail.
6. Tap **OK** to add the contact to the speed dial list.
7. Tap **OK** to exit the **Speed Dial Contact List**.

To add a speed dial entry from the **Contacts** window:

1. Tap **Start** > **Contacts**.
2. Tap a contact name.
3. Tap **Menu** > **Add to Speed Dial**.
4. Tap the up/down arrows to select an available location to assign as the new speed dial entry. The first speed dial location is reserved for voice mail.
5. Tap **OK**.

Editing a Speed Dial Entry

1. Press .
2. Tap **Speed Dial** button.

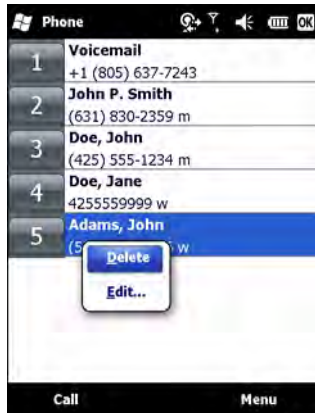



Figure C-13 Speed Dial Contact List

3. Tap and hold the contact name and then tap **Edit**.
4. Change the name, phone number, or location information.
5. Tap **OK**.

✓ **NOTE** Editing names and phone numbers in **Speed Dial** does not alter contact information in **Contacts (Start > Contacts)**.

Deleting a Speed Dial Entry



1. Press .
2. Tap **Speed Dial** button.
3. Tap and hold the contact name.
4. Tap **Delete**.
5. Tap **Yes** to confirm permanently deleting the speed dial entry.

✓ **NOTE** Deleting names and phone numbers in *Speed Dial* does not delete the contact information in **Contacts (Start > Contacts)**.

Using Call History

Use Call History to call someone who was recently called, or recently called in. Call History provides the time and duration of all incoming, outgoing, and missed calls. It also provides a summary of total calls and easy access to notes taken during a call. [Table 4-1](#) lists the call history icons that appear in the **Call History** window.



Table C-2 *Call History Icons*

Icon	Description
	This icon appears next to the contact information for all outgoing calls.
	This icon appears next to the contact information for all incoming calls.
	This icon appears next to the contact information for all missed calls.



Managing Call History

Change views, reset the call timer, and delete calls to manage the calls stored in Call History.

Changing the Call History View

1. Press  to display the Phone dialer.
2. From the Phone dialer, tap **Call History**.
3. Tap  > **Filter** to show the menu.
4. Select a view type from the menu to display only missed calls, outgoing calls, incoming calls, or calls listed alphabetically by caller name.
5. Tap **OK** to exit the **Call History** window.

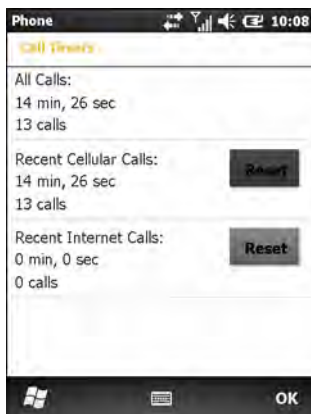

Resetting the Recent Calls Counter

1. Press  to display the Phone dialer.
2. From the Phone dialer, tap **Call History**.
3. Tap .
4. Select **Call Timers...**

**Figure C-14** *Call History - Call Timers*

5. Tap **Reset**. (The **All Calls**: counter cannot be reset.)
6. Tap **OK** to exit the **Call Timers** window.

Deleting All Call History Items

1. Press  to display the Phone dialer.
2. From the Phone dialer, tap **Call History**.
3. Tap .
4. Select **Delete all calls**.
5. Tap **Yes**.
6. Tap **OK** to exit the **Call History** window.

Viewing Call Status

1. Press  to display the Phone dialer.
2. From the Phone dialer, tap **Call History**.
3. Tap an entry. The **Call Status** window appears.

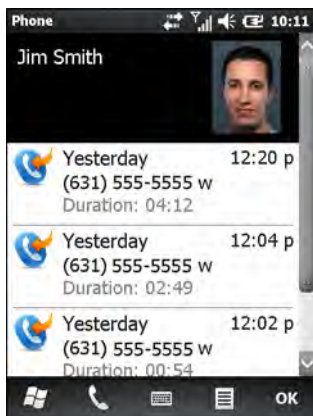

Figure C-15 *Call History - Detail*

✓ **NOTE** When more than one call is on the phone line, only the duration of the first call is recorded.

4. Tap **OK** and then **OK** to exit.

Using the Call History Menu

Use the **Call History** menu to dial voice mail, access the Activation Wizard, save to contacts, view a note, delete a listing, send an SMS, and make a call.

1. Press  to display the Phone dialer.

- From the Phone dialer, tap **Call History**.
- Tap and hold an item in the list.

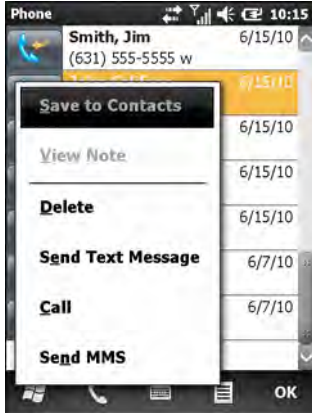



Figure C-16 Call History - Menu

- Select an applicable item from the menu, as needed.
- Depending on the item selected, the appropriate window displays. For example, select **Send Text message** to display the **Text Messages** window.
- Tap **OK** to exit the **Call History** window.

Swapping Calls (GSM)

To move between two phone calls:

- Press  to display the Phone dialer.
- Enter the first phone number and press **Talk**. When the call connects, **Hold** appears on the dialer.
- Tap **Hold** on to place the first number on hold.
- Enter the second number and tap **Talk**.

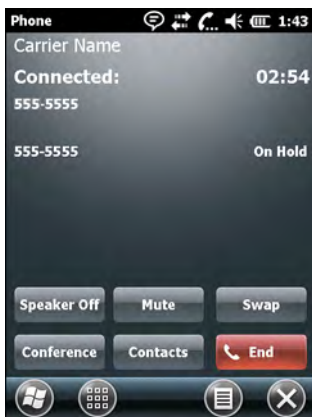



Figure C-17 Call Conferencing - Conferencing

5. Tap **Swap** to move from one call to the other.
6. Tap **End** or press  to end each call.

Swapping Calls (CDMA)

To swap between two incoming phone calls:

1. Tap **Answer** to connect to the first call.

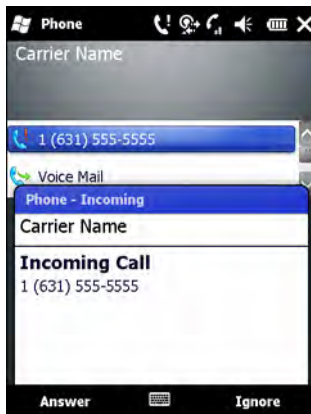



Figure C-18 Answer a Call

2. When a second call arrives, tap **Answer**. The first call is placed on hold.
3. Tap **Flash** to swap from one call to the other.







Figure C-19 Call Swapping



4. Tap **End** or press the red phone key on the keypad to end active call. The remaining call re-connects, tap **Answer** to connect to the call.
5. Tap **End** or press  on the keypad to end the last call.

Conference Calling (GSM)

- ✓ **NOTE** Conference Calling and the number of conference calls allowed may not be available on all services. Please check with your service provider for Conference Calling availability.

To create a conference phone session with multiple people:



1. Press  to display the Phone dialer.
2. Enter the first phone number and press **Talk**. When the call connects, **Hold** appears on the dialer.
3. Tap **Hold** to place the first call on hold.
4. Enter the second phone number and tap **Talk**.
5. After the call is answered, tap  > **Conference** to place the calls in conference mode.
6. Tap **Hold** to place the conference on hold.
7. Enter another phone number and tap **Talk**.
8. After the call is answered, tap  > **Conference** to place all the calls in conference mode.
9. Repeat steps 6 through 8 for up to six phone numbers.
10. Tap **End** or press  on the keypad to end the conference call.

- ✓ **NOTE** To speak privately with one party during a conference call, tap  > **Private**. To include all parties again, tap  > **Conference**.

Three-way Calling (CDMA)

- ✓ **NOTE** Three-way Calling may not be available on all services. Please check with your service provider for availability.

To create a three-way phone session with two people and you as the initiator:

1. Press  to display the Phone dialer.
2. Enter the first phone number and tap **Flash**.
3. To call a second person, tap **Keypad**. Enter the second number and tap **Flash**.
4. When the second person answers the call, tap **Talk** to create a three-way calling session.
5. Tap **Flash** to drop the last call.
6. Press  to drop the first call.

Appendix D Software Installation

The user can install applications and operating system updates on the ES400 using the following:

- Microsoft ActiveSync 4.5 or higher
- Storage Card
- MSP
- AirBEAM
- Image Loader (for updating the operating system).

Refer to the *Microsoft Windows Mobile 6 Help* file for information on CAB files.

Installation Using ActiveSync

To install an application using ActiveSync:

1. Connect the ES400 to a host computer using ActiveSync. See [ActiveSync on page 12-11](#) for more information.
2. Locate the package file on the host computer.
3. In ActiveSync on the host computer, open **Explorer** for the ES400.
4. Copy the CAB file from the host computer to the **\\temp** directory on the ES400.
5. On the ES400, navigate to the **\\temp** directory.
6. Tap on the application CAB file to install the application on the ES400.

Installation Using Storage Card

To install an application using a microSD card:

1. Copy the package CAB file to a microSD storage card using an appropriate storage card reader.
2. Install the storage card into the ES400. See [Installing a microSD Card on page 1-2](#) for more information.
3. On the ES400, open **File Explorer**.
4. Open the **Storage Card** directory.

5. Tap the package CAB file to install the application on the ES400.

Installation Using AirBEAM

The AirBEAM Smart Client provides backward-compatible legacy AirBEAM functionality and backward-compatible legacy MSP 2.x Level 2 Agent functionality.

Refer to the AirBEAM Smart Windows CE Client Product Reference Guide, p/n 72-63060-xx, for instructions for AirBEAM Smart client.

MSP

The MSP 3 Client Software is a set of software components that come pre-installed on the ES400. The MSP 3 Client software consists of the following components:

The **Rapid Deployment Client** provides support for MSP 3 Staging functionality, provides support for the MSP 3 Legacy Staging process, and provides support for backward-compatible legacy MSP 2.x Legacy Staging functionality.

The **MSP Agent** provides MSP 3 Provisioning functionality and Control functionality when used with MSP 3.2 Control Edition.

Refer to the Mobility Services Platform 3.2 User's Guide, p/n 72E-100158-xx, for instructions for using the **Rapid Deployment** and **MSP Agent** clients.

Update Loader Image

Windows Mobile contains an Image Update feature that updates all operating system components. All updates are distributed as update packages. Update packages can contain either partial or complete updates for the operating system. Motorola distributes the update packages on the Support Central Web Site, <http://supportcentral.motorola.com>.

To update an operating system component, copy the update package to the ES400 using one of a variety of transports, including ActiveSync, an microSD card, AirBEAM or MSP.

Download Update Loader Package

1. Go to the Motorola Support Central web site, <http://supportcentral.motorola.com>.
2. Download the appropriate update loader package to a host computer.
3. Locate the update loader package file on the host computer and un-compress the file into a separate directory.

ActiveSync

To install an update loader package using ActiveSync:

1. Connect the ES400 to a host computer using ActiveSync. See [ActiveSync on page 12-11](#) for more information.
2. In ActiveSync on the host computer, open **Explorer** for the ES400.
3. Copy all the update loader package files from the host computer to the **temp** directory on the ES400.
4. On the ES400, navigate to the **temp** directory.
5. Tap on the update loader file, **STARTUPDLDR.EXE**. The Update Loader application installs the update loader package on the ES400.

6. After completion, the ES400 resets and the calibration screen appears.

microSD Card

To install an update loader package using a microSD card:

1. Copy all the update loader package files to the root directory of a microSD card.
2. Install the microSD card into the ES400. See [Installing a microSD Card on page 1-2](#) for installation instructions.
3. Connect the ES400 to AC power. See [Chapter 12, Accessories](#).
4. Press the **1**, **9** and **Power** keys simultaneously.
5. Immediately, as soon as the device starts to boot press and hold the camera button.
6. The Update Loader application looks for the update loader file in the root directory of the microSD card. When it finds the file, it loads the update loader package onto the ES400.
7. After completion, the ES400 resets and the calibration screen appears.

Glossary

A

API. An interface by means of which one software component communicates with or controls another. Usually used to refer to services provided by one software component to another, usually via software interrupts or function calls

Application Programming Interface. See **API**.

B

Bar Code. A pattern of variable-width bars and spaces which represents numeric or alphanumeric data in machine-readable form. The general format of a bar code symbol consists of a leading margin, start character, data or message character, check character (if any), stop character, and trailing margin. Within this framework, each recognizable symbology uses its own unique format. See **Symbology**.

Bit. Binary digit. One bit is the basic unit of binary information. Generally, eight consecutive bits compose one byte of data. The pattern of 0 and 1 values within the byte determines its meaning.

Bits per Second (bps). Bits transmitted or received.

boot or boot-up. The process an ES400 goes through when it starts. During boot-up, the ES400 can run self-diagnostic tests and configure hardware and software.

bps. See **Bits Per Second**.

Byte. On an addressable boundary, eight adjacent binary digits (0 and 1) combined in a pattern to represent a specific character or numeric value. Bits are numbered from the right, 0 through 7, with bit 0 the low-order bit. One byte in memory is used to store one ASCII character.

C

COM port. Communication port; ports are identified by number, e.g., COM1, COM2.

Cradle. A cradle is used for charging the terminal battery and for communicating with a host computer, and provides a storage place for the terminal when not in use.

D

Decode. To recognize a bar code symbology (e.g., UPC/EAN) and then analyze the content of the specific bar code scanned.

E

ESD. Electro-Static Discharge

F

File Transfer Protocol (FTP). A TCP/IP application protocol governing file transfer via network or telephone lines. See **TCP/IP**.

H

Hz. Hertz; A unit of frequency equal to one cycle per second.

Host Computer. A computer that serves other terminals in a network, providing such services as computation, database access, supervisory programs and network control.

I

Internet Protocol Address. See **IP**.

IP. Internet Protocol. The IP part of the TCP/IP communications protocol. IP implements the network layer (layer 3) of the protocol, which contains a network address and is used to route a message to a different network or subnetwork. IP accepts "packets" from the layer 4 transport protocol (TCP or UDP), adds its own header to it and delivers a "datagram" to the layer 2 data link protocol. It may also break the packet into fragments to support the maximum transmission unit (MTU) of the network.

IP Address. (Internet Protocol address) The address of a computer attached to an IP network. Every client and server station must have a unique IP address. A 32-bit address used by a computer on a IP network. Client workstations have either a permanent address or one that is dynamically assigned to them each session. IP addresses are written as four sets of numbers separated by periods; for example, 204.171.64.2.

L

LED Indicator. A semiconductor diode (LED - Light Emitting Diode) used as an indicator, often in digital displays. The semiconductor uses applied voltage to produce light of a certain frequency determined by the semiconductor's particular chemical composition.

Light Emitting Diode. See **LED**.

Liquid Crystal Display (LCD). A display that uses liquid crystal sealed between two glass plates. The crystals are excited by precise electrical charges, causing them to reflect light outside according to their bias. They use little electricity and react relatively quickly. They require external light to reflect their information to the user.

M

MDN. Mobile Directory Number. The directory listing telephone number that is dialed (generally using POTS) to reach a mobile unit. The MDN is usually associated with a MIN in a cellular telephone -- in the US and Canada, the MDN and MIN are the same value for voice cellular users. International roaming considerations often result in the MDN being different from the MIN.

P

PAN . Personal area network. Using Bluetooth wireless technology, PANs enable devices to communicate wirelessly. Generally, a wireless PAN consists of a dynamic group of less than 255 devices that communicate within about a 33-foot range. Only devices within this limited area typically participate in the network.

PING. (Packet Internet Groper) An Internet utility used to determine whether a particular IP address is online. It is used to test and debug a network by sending out a packet and waiting for a response.

Q

QWERTY. A standard keyboard commonly used on North American and some European PC keyboards. "QWERTY" refers to the arrangement of keys on the left side of the third row of keys.

R

RAM. Random Access Memory. Data in RAM can be accessed in random order, and quickly written and read.

Resolution. The narrowest element dimension which is distinguished by a particular reading device or printed with a particular device or method.

RF. Radio Frequency.

Router. A device that connects networks and supports the required protocols for packet filtering. Routers are typically used to extend the range of cabling and to organize the topology of a network into subnets. See **Subnet**.

RS-232. An Electronic Industries Association (EIA) standard that defines the connector, connector pins, and signals used to transfer data serially from one device to another.

S

SDK. Software Development Kit

Shared Key. Shared Key authentication is an algorithm where both the AP and the MU share an authentication key.

SMDK. Symbol Mobility Developer's Kit.

Subnet. A subset of nodes on a network that are serviced by the same router. See **Router**.

Subnet Mask. A 32-bit number used to separate the network and host sections of an IP address. A custom subnet mask subdivides an IP network into smaller subsections. The mask is a binary pattern that is matched up with the IP address to turn part of the host ID address field into a field for subnets. Default is often 255.255.255.0.

Symbology. The structural rules and conventions for representing data within a particular bar code type (e.g. UPC/EAN, Code 39, PDF417, etc.).

T

TCP/IP. (Transmission Control Protocol/Internet Protocol) A communications protocol used to internetwork dissimilar systems. This standard is the protocol of the Internet and has become the global standard for communications. TCP provides transport functions, which ensures that the total amount of bytes sent is received correctly at the other end. UDP is an alternate transport that does not guarantee delivery. It is widely used for real-time voice and video transmissions where erroneous packets are not retransmitted. IP provides the routing mechanism. TCP/IP is a routable protocol, which means that all messages contain not only the address of the destination station, but the address of a destination network. This allows TCP/IP messages to be sent to multiple networks within an organization or around the world, hence its use in the worldwide Internet. Every client and server in a TCP/IP network requires an IP address, which is either permanently assigned or dynamically assigned at startup.

Telnet. A terminal emulation protocol commonly used on the Internet and TCP/IP-based networks. It allows a user at a terminal or computer to log onto a remote device and run a program.

Index

Numerics

3-Way Calling 3-10

A

accelerometer 11-2, 11-11
accessories
 cables 12-2
 microSD card 1-2
 SIM card 1-4
 single slot USB cradle 12-1, 12-3
 specifications A-6
ActiveSync 2-10, 12-11
 deploying CAB files D-1
 icon C-4
 installing 12-11
 setting up a connection 12-11
adaptive frequency hopping 9-1
adjusting volume 2-19
Adobe Reader 2-12
AFH 9-1
AirBEAM 2-10
 deploying CAB files D-2
alarms 2-17, 11-10
alpha primary keypad
 key descriptions B-2
answering a call 3-4, C-8
APN 4-4
auto charge cable 12-10
automatic network setup 4-1
AZERTY keypad B-2

B

backlight 11-2, 11-10
battery

 charging 1-2, 2-19, 12-3
 installing 1-2, 1-5
battery charging 2-19
 using single slot USB cradle 12-3
battery cover 1-2
battery icon 2-7, 2-20
Bing 2-10
Bluetooth 9-1
 adaptive frequency hopping 9-1
 security 9-2
 turning off 9-4
 turning on 9-3
bluetooth
 discovering devices 9-4
 turning on and off 9-3
bullets xvii

C

CAB files
 deployment via ActiveSync D-1
 deployment via AirBEAM D-2
 deployment via image update D-2
 deployment via storage card D-1
calculator 2-10
calendar 2-10
call blocking *See* call barring 4-6
call forwarding 4-6
call history 3-6, C-11
call waiting 4-6
caller id 4-6
camera settings 8-3
cards 2-7
 setup 11-18
CDMA network setup 4-1
changing a PIN for phone use 4-5
charging

- using single slot USB cradle 12-3
- charging error 2-20
- charging temperature 2-20
- cleaning 13-1
- command bar
 - icons C-4
- conference call 3-7, 3-10, C-16
- configuration xv
- Contacts 2-10
- contacts 2-10
- contacts application 3-3, C-6
- conventions
 - notational xvii
- cradles
 - single slot USB 12-3
- creating an email message 6-1

D

- data capture xv
 - scanning 7-1
- data connection 4-4
- DataWedge 7-2
- datawedge 11-3
- device management 2-13
- dialer
 - switching 11-8
- disabling PIN for phone use 4-5
- display xv
- dual network usage 4-3

E

- edit finger print swipes 11-5
- E-mail 2-10
- email setup 11-21
- emergency calls 3-5, C-9
- enabling PIN for phone use 4-5
- ESD 1-2
- Evolution Data-Optimized 3-1, C-4

F

- file explorer 2-11
- finger swipe un-locking 2-22
- Full Home card 2-8
- Fusion 2-17

G

- GPRS
 - data connection 4-4
 - registry file 4-4
 - WAN configuration 4-4

- GPS assist 11-2
- GSM
 - access point name 4-4
 - configure GPRS data connection 4-4
 - settings
 - phone 4-4
 - PIN 4-5
 - security 4-5
 - services 4-6, 4-7
- GSM network setup 4-2

H

- headset 3-5
- hexadecimal keys 5-5
- High-Speed Downlink Packet Access 3-1, C-4

I

- icons
 - ActiveSync C-4
 - battery 2-7, 2-20
 - speaker 2-19
 - status 2-6
 - task tray C-4
- image update
 - deploying CAB files D-2
- information, service xviii
- installing battery 1-5
- installing microSD card 1-2
- installing the battery 1-5
- internet
 - wireless connection 4-4
- Internet Explorer Mobile 2-11
- internet sharing 2-11
- IrDA 11-2

K

- key descriptions
 - alpha primary keypad B-2
- key remapping 11-12
- keylight 11-2, 11-10
- keypad remapping 2-2
- keypads xv
 - key descriptions B-2
 - special character key 2-2, B-4

L

- LEDs
 - scan and decode 7-1
- lithium-ion battery 1-1
- lock plus 11-3

finger swipe locking 11-4
 password locking 11-4
 lock switch 11-2
 locking the ES400 keypad 2-21, 11-3

M

maintenance 13-1
 manual network setup 4-1
 masked characters 5-5
 master reset 11-3, 11-15
 Media Player 2-12
 memory xv
 memory manager 2-14
 messaging 2-11
 microSD card 1-2, 1-9
 installation 1-2
 installing 1-2
 removal 1-9
 Microsoft locking 11-6
 MMS messaging 6-4, 11-26
 setup 11-26
 Motorola Home screen 2-5
 MSN Money 2-11
 MSN Weather 2-11
 MSP Agent 2-11
 muting a call 3-5, C-9
 My Apps 2-10

N

nav pad 11-2
 navigation bar
 icons 2-6
 network
 configuring GSM WAN 4-4
 network activation 1-7
 CDMA 1-7
 GSM/UMTS 1-7
 notational conventions xvii
 notes 2-11

O

operating environment A-1
 operating system xv
 optical nav pad 2-3
 settings 11-11

P

pass-phrase 5-5
 password unlocking 2-21
 passwords 11-4, 11-7

hint 11-4
 Phone 2-11
 phone
 answering a call 3-4, C-8
 call history 3-6, C-11
 call swapping C-14, C-15
 conference call 3-7, 3-10, C-16
 contacts 3-3, C-6
 muting a call 3-5, C-9
 speed dial
 adding entry C-10
 calling C-7
 deleting entry C-11
 editing entry C-11
 text messaging 6-2
 three-way call 3-10, C-16
 three-way calling 3-7
 using keypad 3-1, C-5
 phone network setup 11-2
 phone security 4-5
 phone settings 4-4
 pictures 2-11
 PIN, changing for phone 4-5
 PIN, disabling for phone use 4-5
 PIN, enabling for phone use 4-5
 power & radio 2-15
 power off the ES400 1-8
 power profiles
 creating 11-9
 printing 2-20
 program shortcut 2-9
 programs 2-13

Q

QWERTY keypad B-1
 QWERTZ keypad B-2

R

radios xv
 rapid deployment 2-11
 recording videos 8-5
 Remote Desktop Mobile 2-11
 removing the battery cover 1-2
 reset 2-21
 resume 9-3

S

scanning with digital camera 7-1
 screen navigation 2-3
 security
 Bluetooth 9-2

- sending a text message 6-2
 - service information xviii
 - services, GSM
 - call barring 4-6
 - call forwarding 4-6
 - call waiting 4-6
 - caller id 4-6
 - text messages 4-7
 - voice mail 4-7
 - Settings 2-11
 - settings 2-18, 11-1
 - about 11-2
 - accelerometer 11-2
 - backlight 11-2
 - beam 11-2
 - buttons 11-2
 - certificates 11-2
 - connections 11-2
 - customer feedback 11-3
 - dial switcher 11-2
 - encryption 11-3
 - error reporting 11-3
 - external GPS 11-3
 - GPS assist 11-2
 - GSM 4-4
 - holster 11-2
 - keylight 11-2
 - lock 11-1
 - lock switch 11-2
 - memory 11-3
 - nav pad 11-2
 - owner information 11-2
 - phone 11-2
 - phone network setup 11-2
 - power 11-1
 - regional settings 11-3
 - remove programs 11-3
 - screen 11-3
 - voice commander 11-2
 - Wi-Fi 11-2
 - wireless manager 11-2
 - settings alarms 11-10
 - SIM card 1-9
 - accessories 1-4
 - installation 1-4
 - removal 1-9
 - Simple Home card 2-7
 - single slot USB cradle 12-1, 12-3
 - charging 12-3
 - SMS Staging 2-11
 - sound profiles 2-14
 - creating 11-8
 - speaker icon 2-19
 - special character key 2-2, B-4
 - special characters 2-2
 - speed dial C-7, C-10
 - starting the ES400 1-6
 - status 2-18
 - status bar 2-5
 - status icon 2-6
 - battery 2-7, 2-20
 - speaker 2-19
 - storage card
 - deploying CAB files D-1
 - strap 1-1
 - stylus 1-1
 - subscriber identification module 1-4
 - suspend 9-3
 - suspend the ES400 1-8
 - switching the dialer 11-8
 - synchronize with PC
 - using Bluetooth 9-9
- ## T
- taking panorama pictures 8-1
 - taking pictures 8-1
 - Task Manager 2-12
 - task tray icons C-4
 - tasks 2-12
 - technical specifications A-1
 - accessories A-6
 - temperature A-2
 - charging 2-20
 - Text 2-12
 - text messages 4-7
 - three-way call 3-10, C-16
 - Three-Way Calling 3-10
 - three-way calling 3-7
 - tile bar 2-10
 - Time Tracker card 2-9
 - troubleshooting 13-5
- ## U
- unpacking 1-1
 - using wired headset 3-5
- ## V
- video settings 8-5
 - videos 2-11
 - viewing a text message 6-2
 - viewing an email message 6-1
 - viewing pictures and video 8-7
 - Voice Commander 2-12
 - voice commander 3-10
 - settings 11-27

voice mail 4-7

W

Weather card 2-9

Wi-Fi 11-2

Windows Live 2-12

Windows Live Messenger 2-11

wired headset 3-5

wireless

 internet 4-4

Wireless Companion 2-12

wireless manager 11-2

WLAN 802.11a/b/g xv

WPAN Bluetooth xv

WWAN

 configuring GSM 4-4



MOTOROLA

Motorola, Inc.
One Motorola Plaza
Holtsville, New York 11742, USA
1-800-927-9626
<http://www.motorola.com/enterprisemobility>

MOTOROLA and the Stylized M Logo and Symbol and the Symbol logo are registered in the U.S. Patent and Trademark Office.
All other product or service names are the property of their registered owners.
© Motorola, Inc. 2010